

GERMIG



TECHNICAL

2003

ANNUAL



Grundig Service

Hotline Germany...

Technical Support:

TV	0180/52318-41*
TV	0180/52318-49*
SAT	0180/52318-48*
VCR/LiveCam	0180/52318-42*
HiFi/Audio	0180/52318-43*
Car Audio	0180/52318-44*
Telecommunication	0180/52318-45*
Fax:	0180/52318-51*

Spare Parts Order Desk:

Phone: 0180/52318-40*
Fax: 0180/52318-50*

Service Centres

Phone: 0180/52318-52*
Fax: 0180/52318-46*

Süd

Beuthener Str. 65
90471 Nürnberg
e-mail: KDSued@grundig.com

West

Horbeller Str. 19
50858 Köln
e-mail: KDWest@grundig.com

Phone

0180 - 523 1852*

Ost

Am Borsigturm 62
13507 Berlin
e-mail: KDOst@grundig.com

Fax

0180 - 523 1846*

Nord

Kolumbusstr. 14
22113 Hamburg
e-mail: KDNord@grundig.com

*chargeable

We would be obliged for any tips and suggestions or criticism which we shall give our attention. Please send to fax number: **++49 9 11 - 7 03 19 05** or via e-mail to **doku.cs@grundig.com**

Grundig AG, D-90471 Nürnberg

Printed in Germany • Copyright by Grundig

Technical data E. & O.E. • Alterations reserved

Technical Annual 2003

Dear Readers,

In order not to go beyond the limits of a booklet this issue contains as usual only the latest data and technical changes.

For information frequently repeated in the past few years please refer to the previous issues of the Grundig Technical Annual.

Contents:

General Part.....	1.1
TV Technology.....	2.1
Video Technology	3.1
Camcorder Technology	4.1
Satellite Reception	5.1
Audio Technology	6.1

Subject to alteration

Partners help each other

Please help us find hidden faults and return all modules with a brief description of the fault.

For this purpose, a fault tag or adhesive label is enclosed with all modules (insert cards) delivered by the GRUNDIG service organisation.

<p>FÜR IHR RÜCKABETEIL FOR RETURNING FAULTY MODULES ALLEGARE AL PEZZO CHE VIENE RIMANDATO INDIETRO POUR RETOURNER AVEC LE MODULE DEFECTUEUX PARA DEVOLUCIÓN DE MÓDULOS AVERIADOS</p>	<p>Fehleranhänger für Module / Label tag for modules Cartellino dei difetti per i moduli / Fiche suivieuse pour module Etiqueta de avería para módulos</p> <p><input type="checkbox"/> Fehler tritt sofort auf / Fault occurs immediately / Il difetto compare subito Le défaut apparaît immédiatement / La avería aparece inmediatamente</p> <p><input type="checkbox"/> Fehler tritt nur zeitweise auf / Fault occurs intermittently / Il difetto compare solo a periodi / Le défaut est intermittent / La avería aparece intermitentemente</p> <p><input type="checkbox"/> Fehler tritt nach ca. Minuten aut Fault occurs after approx minutes Il difetto compare dopo ca. minuti Le défaut apparaît après environ minutes de fonctionnement La avería aparece tras minutos</p> <p><input type="checkbox"/> Wackelkontakt / intermittent contact / Contatto difettoso Mauvais contact intermittent / contacto intermitente</p> <p>Sonstige Fehlererscheinungen: / Other faults: / Altri difetti: Autres défauts: / Otras averías: _____</p> <p>_____</p> <p>_____</p>
---	---

<p>○</p>	<p>Bitte unterstützen Sie uns beim Auffinden versteckter Fehler: Versehen Sie alle Modul-Rückläufer mit vollständig ausgefüllten Fehleranhängern!</p> <p>Please help us to trace obscure faults: Ensure all modules are returned with label tag completed!</p> <p>Collaborate con noi nella ricerca deidifetti: corredate ogni modulo che rimandate indietro dei cartellino dei difetti compilato in tutti i suoi punti!</p> <p>Afin de nous permettre d'améliorer la Qualité de notre service, nous vous prions de nous renvoyer avec votre module, cette étiquette dûment renseignée. Merci pour votre collaboration.</p> <p>Ayúdenos a encontrar las averías ocultas: procuren que cada módulo devuelto vaya con su etiqueta de avería para módulos debidamente relienda!</p>
----------	---

Contents: General Part

Addresses:

Grundig AG	1.2
Return of Spare Parts, Exchange Parts, Exchange Products and Picture Tubes under Guarantee	1.2
Grundig AG Sales Department Germany	1.3
Grundig AG Sales Department International	1.4
Grundig AG Overseas Sales Division.....	1.6
Measurement Instruments Calibration and Repair Service.....	1.13
Service Training Courses for our Customers	1.14
Private Study with Service Training Manuals	1.15
ISDN InfoTip®	1.16
Grundig Universal Remote Controls.....	1.17
Pinning of Sockets and Plugs.....	1.23

To be better readable part numbers are shown with two spaces.
 For ordering spare parts please indicate part numbers as **twelve-figure number** without spaces.

GRUNDIG AG**Head Office**

Beuthener Str. 41-43, 90471 Nürnberg
 Tel. (09 11)7 03-0, Fax: (09 11) 703-74 44 e-mail: info@grundig.com
 Internet: http://www.grundig.com

Central Service, Beuthener Str. 55, 90471 Nürnberg
 Tel.: (0911) 703-0 Fax: -19 03 e-mail: centralservice@grundig.com

Central Warranty Remuneration, Kolumbusstraße 14, 22113 Hamburg
 Tel.: (0180) 500 02 95* Fax: (0180) 500 02 96* e-mail: garantie@grundig.com

GRUNDIG Customer Service Centres / Workshops:

... for the delivery of repair goods

- South

Beuthener Str. 65 Tel.: (0180) 523 18 52*
 90471 Nürnberg Fax: (0180) 523 18 46*
 e-mail: KDSued@grundig.com

- West

Horbeller Str. 19 Tel.: (0180) 523 18 52*
 50858 Köln Fax: (0180) 523 18 46*
 e-mail: KDWest@grundig.com

- East

Am Borsigturm 62 Tel.: (0180) 523 18 52*
 13507 Berlin Fax: (0180) 523 18 46*
 e-mail: KDOst@grundig.com

- North

Kolumbusstr. 14 Tel.: (0180) 523 18 52*
 22113 Hamburg Fax: (0180) 523 18 46*
 e-mail: KDNord@grundig.com

*chargeable

GRUNDIG Spare Parts Service

... for handling of exchange parts

Please send all components and products which are subject to exchange directly to the address below indicating your customer number..

GRUNDIG Central Service

- Tor 7 / 8 -
 Beuthener Straße 55
 90471 Nürnberg

We ask you to send all picture tubes under guarantee with the exception of Philips tubes to above mentioned address. **Pass all warranty claims arising from Philips picture tubes directly on to Philips.** For advance replacement please call...

Tel.: (040) 28 52 22 55
 Fax: (040) 28 52 22 03

Grundig AG Sales Department Germany

Grundig AG
Beuthener Strasse 41
90471 Nuremberg
Germany

Tel.: (+49-911) 703-0
Fax: (+49-911) 705 376
e-mail: info@grundig.com
<http://www.grundig.com>

Vertriebsregion Süd

Beuthener Str. 65
90471 Nürnberg

Vertriebsleiter
Herr Thomas Baier
Tel: 0911 / 703-1583
thomas.baier@grundig.com

Vertriebsregion Süd / West

Am Hardtwald 9
76275 Ettlingen

Vertriebsleiter
Herr Elmar Hofmann
Tel: 07243 / 3240-10
elmar.hofmann@grundig.com

Vertriebsregion Mitte

Dornhofstrasse 100
63263 Neu Isenburg

Vertriebsleiter
Herr Werner Murko
Tel: 06102 / 20238-10
werner.murko@grundig.com

Vertriebsregion West

Horbellener Strasse 19
50858 Köln

Vertriebsleiter
Herr Jürgen Schmitz-Axe
Tel: 02234 / 9581-115
juergen.schmitzaxe@grundig.com

Vertriebsregion Nord

Kolumbusstrasse 14
22113 Hamburg

Vertriebsleiter
Herr Reinhard Domröse
Tel: 040 / 73331-220
reinhard.domroese@grundig.com

Vertriebsregion Ost

Am Borsigturm 62
13509 Berlin

Vertriebsleiter
Herr Friedhelm Hockenbrink
Tel: 030 / 43803-50
friedhelm.hockenbrink@grundig.com

Grundig AG Sales Department International**HEADQUARTERS**

Grundig International
Beuthener Strasse 41
90471 Nuremberg
Germany

Tel.: (+49-911) 703-0
Fax: (+49-911) 703-9204
e-mail: info@grundig.com
<http://www.grundig.com>

Austria - Grundig Austria GmbH
Breitenfurter Str. 43-45, A-1121 Wien
Tel.: (+43-1) 81 117-0, Fax: (+43-1) 81 117 713
e-mail: webMaster@Grundig.co.at

Belux - Grundig Belux N. V.
Deltapark Unit 3, Weihoek 3 G, B-1930 Zaventem
Tel.: (+32-2) 716 04 00, Fax: (+32-2) 716 03 80
e-mail: paquita.gallego@grundig.com

Croatia - Grundig Hrvatska d.o.o.
Metalceva 5, HR - 10000 Zagreb
Tel.: (+385-1) 309 34 06, Fax: (+385-1) 309 17 78
e-mail: grundig-hrvatska@zg.tel.hr

Czech Republic - Grundig spol. s r.o.
Koperniková 2, CZ - 12 000 Praha 2
Tel.: (+420-2) 2423 9099, (+420-2) 2423 9081, Fax: (+420-2) 2423 5101,
e-mail: Grundig@login.cz

Denmark - Grundig Danmark A/S
Lejrvej, DK-3500 Vaerloese
Tel.: (+45) 44 486 822, Fax: (+45) 44 486 667
e-mail: post@grundig.dk

Finland - Grundig Oy
Pihatörmä 1 A, P.O.Box 25, FIN-02241 Espoo
Tel.: (+358) 9 725 07 500, Fax: (+358) 9 725 07 521
e-mail: grundig@grundig.fi, internet: <http://www.grundig.fi>

France - Grundig France S. A.
5, Boulevard Marcel Pourtout, F-92563 Rueil Malmaison Cedex
Tel.: (+33-1) 413 926 26, Fax: (+33-1) 470 869 48
e-mail: infoplus.fr@grundig.com

Hungary - Grundig Magyarország Kft.
Bécsi út 85, H - 1036 Budapest
Tel.: (+36-1) 25 08 142, (+36-1) 25 08 143, Fax: (+36-1) 25 08 144
e-mail: grundig@grundig.hu

Italy - Grundig Italiana S. p. A.
Via G. B. Trener 8, I-38100 Trento
Tel.: (+39-0461) 893 111, Fax: (+39-0461) 893 207 / 893 408 (KD)
e-mail: asstec@grundig.it

Netherlands - Grundig Nederland B. V.
Industriegebied Arnstel 1, Joan Muyskenweg 22, NL-1096 CJ Amsterdam
Tel.: (+31-20) 568 15 68, Fax: (+31-20) 568 14 66
e-mail technical info: niek.deboer@grundig.com
e-mail general info: leontine.vanzanten@grundig.com

Norway - Grundig Norge A/S

Glynitveien 25, N-1402 Ski

Tel.: (+47) 64 878 200, Fax: (+47) 64 876 610

e-mail: grundig.norge@grundig.no, Internet: <http://www.grundig.no>**Poland - Grundig Polska Sp. z o.o.**

Ul. Moldawska 9, 02-127 Warszawa

Tel.: (+48 22) 668 62 66, Fax: (+48 22) 668 62 54,

e-mail: biuro.warszawa@grundig.pl

Poland - Grundig Polska Sp. z o.o. (Serwis)

Ul. Czéstochowska 140, PL - 62-800 Kalisz

Tel.: (+48-62) 7 66 77 70, Fax: (+48-62) 7 66 77 72

e-mail: biuro.kalisz@grundig.pl

Portugal - Grundig Portuguesa, Lda.

Rua Bento de Jesus Caraça, 17, P-1495-686 Cruz Quebrada

Tel.: (+351-21) 4 15 67 00, Fax: (+351-21) 4 19 90 83

e-mail: gpl@mail.telepac.pt, Internet: <http://www.grundig.pt>**Russia - Grundig - Representative Office Moscow**

Denissovskij Pereulok 26-28, 107055 Moscow

Tel: (+7-095) 933 5131, Fax: (+7-095) 933 5132

e-mail: grundig@dol.ru, Internet: <http://www.grundig.ru>**Slovenia - Grundig Slovenija d.o.o.**

Dunajska 22, SL - 1511 Ljubljana

Tel.: (+386-1) 328 879, (+386-1) 328 883, Fax: (+386-1) 328 686

e-mail: mam.grundig@siol.net

Spain - Grundig España S. A.

Solsonés, 2, B3, Edificio Muntadas (Mas Blau 1), E-08820 El Prat de Llobregat (Barcelona)

Tel.: (+34-93) 479 92 00, Fax: (+34-93) 4 79 92 01

e-mail: info@grundig.es

Sweden - Grundig Svenska AB

Esbogatan 18, P.O.Box 74, 16494 Kista

Tel.: (+46-8) 629 85 30, Fax: (+46-8) 629 85 70

e-mail: info@grundig.se

Switzerland - Grundig (Schweiz) AG

Steinackerstr. 28, CH-8302 Kloten

Tel.: (+41-1) 81 581 11, Fax: (+41-1) 81349 31

e-mail: swiss@grundig.com

United Kingdom - Grundig UK Limited.

Elstree Business Centre, Elstree Way, Borehamwood, Hertfordshire, WD6 1RX

Tel.: (+44-20) 83 24 94 00, Fax: (+44-20) 83 24 94 01

e-mail: Grundig@grundig.co.UK, Internet: <http://www.grundig.co.uk>

A U S T R A L I A**AUSTRALIA and NEW ZEALAND**

Grundig Australia Pty. Ltd.
9 / 4 Avenue Of Americas
Newington NSW 2127
Sydney

Postal address:

P.O.Box 6287
Silverwater NSW 1811
Sydney

e-mail:

information:**technique:****sales:****service:****www.grundig-australia.com**

Tel.: (+61-2) 9714 3434
Office Fax: (+61-2) 9737 0516
Service Fax: (+61-2) 9737 0517
office@grundig-australia.com
support@grundig-australia.com
sales@grundig-australia.com
service@grundig-australia.com

http://

Grundig AG – Overseas Sales Division**H E A D Q U A R T E R S**

Grundig AG
Overseas Sales Division
Beuthener Strasse 41
90471 Nuremberg
Germany

Tel.: (+49-911) 703-0
Fax: (+49-911) 703-7134
e-mail: info@grundig.com
<http://www.grundig.com>

E U R O P E**RUSSIA und UKRAINE**

Grundig - Representative Office Moscow
Denissovsij Pereulok 26-28
105005 Moscow
for Distributors please refer to ->

Tel.: (+7-095) 933 5131
Fax: (+7-095) 933 5132
e-mail: grundig@dol.ru
<http://www.grundig.ru>

DISTRIBUTORS IN EUROPE**CYPRUS**

Ideal Grafico Ltd.
14 C Stassinou Ave.
P.O. Box 24809
Nicosia 1304

Tel.: (+357-22) 2752 109
Fax: (+357-22) 2750 943
e-mail: info@ideal.com.cy

CYPRUS

Kansu Ercantan Y'pletmeleri Ltd.
Dr. Fazy'ı Küçük Bulvarı
Renault Plaza Yany'
Lefkopa
Mersin 10 Turkey

Tel.: (+90-392) 22 53 333, 22 54 555
Fax: (+90-392) 22 53 433
e-mail: mercantan@superonline.com

ESTONIA

Nexus Büroo Oü
Mooni 18
10613 Tallinn

Tel.: (+372) 6608 031
Fax: (+372) 6608 030
e-mail: Nexus@online.EE

GREECE

ELEX S.A.
13th km National Road (Athens-Lamia)
Nea Kifissia
Athens 14564

Tel.: (+30-210) 8075 403
Fax: (+30-210) 8076 704
e-mail: info@grundig.gr
http://www.grundig.gr

ICELAND

Television Center Ltd.
Sidumula 2
128 Reykjavik

Tel.: (+354-5) 689 090
Fax: (+354-5) 680 390
e-mail: verslun@sm.is
http://www.sm.is

LATVIA

Elkor Group
201 Brivibas Str.,
Riga, LV1039

Tel.: (+371-7) 07 07 07
Fax: (+371-7) 07 07 22
e-mail: tehnik@elkor.lv
http://www.elkor.lv

LITHUANIA

Ogmios Pulsas UAB
P. Luksio Str. 23
LT-2600 Vilnius,

Tel.: (+370-5) 274 1750, 274 1751
Fax: (+370-5) 274 1760
e-mail: pulsas@ogmios.lt
http://www.ogmios.lt

MALTA

Jokate Group of Co. Ltd.
G'Mangia Hill
P.O. Box 1
Msida

Tel.: (+356) 21 221 012
Fax: (+356) 21 243 154
e-mail: jokate@vol.net.mt

MOLDOVA

Alina Electronic
45, Banulesku Bodoni street,
Kishinev City, MD2012

Tel.: (+373-2) 242502, 228842
Fax: (+373-2) 243577
e-mail: info@alina.md

TURKEY

Mercansoy A.S.
Yildirim Mah.
Ali Fuat Basgil Cad. 43, Bayrampasa
34170 Istanbul

Tel.: (+90-212) 649 3296
Fax: (+90-212) 537 5698
e-mail: infomer@mercansoy.com.tr
http://www.mercansoy.com.tr

AFRICA**ALGERIA**

E.I.P.EL
14, Rue Lulli
Alger 16000

Tel.: (+213-21) 860 377
Fax: (+213-21) 860 260
e-mail: eipel@wissal.dz

Congo

Multibis Ltd.
B.P. 12799
Kinshasa

Tel.: (+243-88) 43 986
Fax: (+243-88) 45 787
e-mail: multibis@ic.cd

Egypt

IEP International Electrical Products
3rd Industrial Zone
Lot No. 268
P.O.Box 171
6th October City

Tel.: (+20-800) 555 5555
Fax: (+20-2) 686 0062
e-mail: ahmedkamel@mfg.bahgat.com
http://www.bahgat.com

Egypt

Int. Company for Electronic Devices
3 Monshaet El - Katabah
Kasr El-Nile
Cairo

Tel.: (+20-2) 390 96 11
Fax: (+20-2) 390 71 81
e-mail: ico@riv.org

ETHIOPIA

Cabey Private Limited
Box 18192
Addis Ababa

Tel.: (+251-1) 711 941, 713 726
Fax: (+251-1) 711 587
e-mail: cabey@telecom.net.et

GHANA

Deon 2000 Ltd.
65 Josiah Tongogara St.
Labone
Accra

Tel.: (+233-21) 783 906, 783 908
Fax: (+233-21) 777 197
e-mail: deon2000@ghana.com

KENYA

Jacky's Ltd.
Laxcon House
Limuru Road, P.O. Box 45977
Nairobi

Tel.: (+254-2) 750 974, 746 452
Fax: (+254-2) 749 690
e-mail: jackys@nbnet.co.ke

MOROCCO

Umareq
43, Bld. Ibn. Tachfine
Casablanca

Tel.: (+212-22) 301 542
Fax: (+212-22) 303 003
e-mail: Umareq@casanet.net.ma

NAMIBIA

Ackermann group of comp.cc
4 Karin Muir Str.
P.O. Box 80262
Olympia - Windhoek

Tel.: (+264-61) 244 474
Fax: (+264-61) 258 164
e-mail: grundig@iway.na

NIGERIA

Grand Products Co. Ltd.
28 Warf Road, Apapa
P.O. Box 1891
Festac Town - Lagos

Tel.: (+234-1) 545 1065, 587 1725
Fax: (+234-1) 545 3200
e-mail: gpcl@grandproducts.org
e-mail: grandproducts@panaol.com

SOUTH AFRICA

HI FI Corporation
Unit 49,50,51
Longmeadow Business State Ayrshire Rd. Modderfontein
P.O. Box 1544, Bramley 2018,
Johannesburg

Tel.: (+271-11) 372 7313
Fax.: (+271-11) 372 7388
e-mail.: lizelle@hificorp.com

SOUTH AFRICA

Philtec Service
62 Old Main Road, Pinetown 3601
P.O. Box 816 Pinetown 3600

Tel.: (+27-31) 7012511
e-mail: philtec@netactive.co.za

UGANDA

Baba Trading Est. Ltd.
P.O. Box 26226
Kampala

Tel.: (+256-41) 223 426
Fax: (+256-41) 223 426
e-mail: baba@africaonline.co.ug

ZIMBABWE

PortJerre Electric Pvt. Ltd.
2 Taberer Avenue Hillside
P.O. Box Cranborne
Harare

Tel.: (+263-91) 233 822
Fax: (+263-4) 753 938
e-mail: chepzim@africaonline.co.zw

AMERIKA**ARGENTINA**

Foxman Fueguina
Av. Eva Perón 7455 / 85
1439 Buenos Aires

e-mail: **information
technique
sales
web:**

Tel.: (+54-11) 4686 1071
Fax: (+54-11) 4686 4551
info@crowm-mustang.com.ar
service@crowm-mustang.com.ar
ventas@crowm-mustang.com.ar
http://www.grundig.com.ar

MEXICO

Grupo Gomo
Blvd. Adolfo Lopez Mateos 2370, Piso
Col. Altavista
C.P. 01060, Mexico D.F.

Tel.: (+52-55) 5550 6650
Fax: (+52-55) 5616 2853
e-mail: lgorordo@gomo.com.mx

USA / CANADA (Distributor for World Receivers)

ETON Corporation
1015 Corporation Way
Palo Alto, CA 94303

Toll free numbers

Tel.: (+1-650) 903 3866
Fax: (+1-650) 903 3867
e-mail: ehozour@grundigradio.com
http://**www.grundigradio.com**
USA (+1-800) 872 2228
Canada (+1-800) 637 1648

ASIA**MIDDLE EAST** (Regional Office)

Grundig Gulf FZE
P.O. Box 61012
Jebel Ali
Dubai / U.A.E.

Tel.: (+971-4) 8838 989
Fax: (+971-4) 8838 798
e-mail: gmeja@emirates.net.ae
http://**www.grundiggulf.com**

Distributors in Asia**ARMENIA**

Zig-Zag Co. Ltd.
Charents Str
25 Yerevan

Tel.: (+374-1) 556 010
Fax: (+374-1) 559 099
e-mail: service@zigzag.am
http://**www.zigzag.am**

AZERBAIJAN

Universal Technics Co. Ltd.
Nizami Street 125
Baku

Tel.: (+994-12) 987 705
Fax: (+994-12) 984 455
e-mail: fuad@unitech.az
http://**www.unitech.az**

BAHRAIN

United Commercial Co. WLL
P.O. Box 166
Manama

Tel.: (+973) 731 691
Fax: (+973) 730 279
e-mail: united@batelco.com.bh

BURUNDI

GENERAL TRADING SERVICES SA
Quartier Industriel
BP 2283
Bujumbura

Tel.: (+25-7) 21 8319
Fax: (+25-7) 21 2048
e-mail: gts@usan-bu.net

CHINA / HONGKONG

Datum Networks Corp. Ltd. -
Jebsen Group
28/F., Caroline Centre
28 Yun Pin Road
Causeway Bay / Hongkong

Tel.: (+852) 2926 6141
Fax: (+852) 2375 7656
e-mail: kmpau@mail.jebsen.com.hk

CHINA P.R

East Kit Electronics (Shanghai) Co. Ltd.
No. 2618 GU Dai Road,
Post Code 201100,
Shanghai

Tel.: (+86-21) 649 88236
Fax: (+86-21) 649 29098
e-mail: yuqing.guo@kitking.com

INDIA

EMISSION ELECTRONICS PVT LTD
101 Ravi Industrial Estate
Mahakali Caves Road
Andheri (East)
Mumbai 400093

Tel.: (+91-22) 832 8451
Fax: (+91-22) 837 5001
e-mail: emission@vsnl.com

IRAN

Pars Electric Manufacturing Co.
Km. 11 Jadeh Makhsous Karadj.
Tehran

Tel: ++98-21-490 5100
Fax: ++98-21-490 5095
e-mail: commerce@parselectric.com

IRAN

PARS Grundig – Kish Co.
Pardis 2 Shopping Centre
Ground Floor, No. 48 A
Kish Free Zone Island

Tel.: (+98-21) 490 3651
Fax: (+98-21) 490 3652
e-mail: pars-grundig-kish@kanoon.net
web: <http://www.parselectric.com>

ISRAEL

Newpan Ltd.
14 Rosansky St.
Rison LeZion 75706

Tel.: (+972-3) 700 700 727
Fax: (+972-3) 962 8332
e-mail: newpan@newpan.co.il
<http://www.newpan.co.il>

JORDAN (Distributor for Projects)

Gi.Rho.Ma Co.
Kalbouneh Center
Prince Moh'd Street
P.O. Box 639
Amman 11118

Tel.: (+962-6) 566 3964, 566 3848
Fax: (+962-6) 566 3945
e-mail: girhoma@go.com.jo

JORDAN (Distributor for Consumer Electronics)

JHIL Co.
P.O. Box 803
Amman 11118

Tel.: (+962-6) 569 2353
Fax: (+962-6) 569 2352

KAZAKHSTAN

Asia Technics Group
179A/22 Tole Bi Str.
Almaty, Kazakhstan 480096

Tel.: (+732-72) 506496
Fax: (+732-72) 503678
e-mail: atg@atg.kz

KUWAIT

Morad Yousuf Behbehani
P.O. Box 146
13002 Safat

Tel.: (++965) 484 4352, 484 4000
Fax: (++965) 484 4053
e-mail: moradyb@qualitynet.net

LEBANON

Boulos Freres & Co.
P.O. Box 1656
Hazmieh Boulevard
Beirut

Tel.: (++961-5) 452 332, 459 932
Fax: (++961-5) 454 155
e-mail: boulos@dm.net.lb

MALAYSIA

Light Way Enterprises Sdn. Bhd.
37, Jalan Kartunis U1/47
Temasya Industrial Park, Glenmarie
40150 Shah Alam Selangor
Darul Ehsam

Tel.: (++60-3) 5569 1695, -96, -97, -98
Fax: (++60-3) 5633 1054
e-mail: grundig@tm.net.my

OMAN

Oman Marketing & Services Co.
P.O. Box 2734
Ruwi 112
Sultanate of Oman

Tel.: (++968) 562 902
Fax: (++968) 561 606
e-mail: mehansen@omasco.com.om

QATAR

Mannai Trading
P.O. Box 76
Doha

Tel.: (++974) 441 2555
Fax: (++974) 437 0959
e-mail: padmanabhan.c@mannai.com.qa

SAUDI ARABIA

Anasia Trading Est.
P.O. Box 50959 Fax: (++966-2) 653 3504
Jeddah 21533

Tel.: (++966-2) 653 3661
e-mail: ateffahmy@anasia.com.sa

SINGAPORE

Datum Technologies LTD.
44 Changi South St. #1
Changi South Industrial Estate
Singapore 486762

Tel.: (++65) 6297 3777
e-mail.: datum@mjc.com.sg

SOUTH KOREA (Distributor for HiFi / Audio products)

SAEM Energy Co. Ltd.
2F Rifa Bldg. 9-9 Dangсандong 5ga
Youngdeunpo-gu
Seoul 150-045

Tel.: (++82-2) 2068 0809
Fax: (++82-2) 2068 0386
e-mail: saemcom@nuri.net

SOUTH KOREA (Service Partner CTV)

Twentyone International Trading
Koryo Academitel RM 1421
437-3, Ahyun-Dong, Mapu-Gu
Seoul

Tel.: (++82-2) 761 8830
Fax: (++82-2) 783 0363

SYRIA

Hawa Audio Design
Rawda, Tanoukhy St.
P.O.Box 26
Damascus

Tel.: (++963-11) 331 5345
Fax: (++963-11) 332 1388
e-mail: hawamail@cyberia.net.lb

TAIWAN R.O.C.

GRE Trading Co. Ltd.
5 F, No. 4 Long 8, Lane 45
Pao-Hsing Road, Hsintien
Taipai

Tel.: (++886-2) 2917 7853
Fax: (++886-2) 2911 7212
e-mail: gretpe@ms32.hinet.net

U.A.E.

Jumbo Central Service Center
P.O. Box 3426
Rashidiya
Dubai

Tel.: (++971-4) 285 1485

Fax: (++971-4) 285 1438
e-mail: supra.servicedesk@jumbo.co.ae

U.A.E.

Al Gurg Electronics
P.O. Box 325
Dubai

Tel.: (++971-4) 3376 804
Fax: (++971-4) 3340 590
e-mail: gurgelec@emirates.net.ae

YEMEN

M/S General Electronics Company
P.O. Box 18105
Haddah Street
Sanaa

Tel.: (++967-1) 440 460
Fax: (++967-1) 440 638
e-mail: gec.yemen@y.net.ye

GENERAL EXPORT AGENT

TEC Techno Export + Consulting GmbH
Großmooring 18
21079 Hamburg

Tel.: (++49-40) 766 9960
Fax: (++49-40) 766 99628
e-mail: TEC-Hamburg@t-online.de

GERMANY

Measurement Instruments Calibration and Repair Service

Our services:

- **Calibration according to DIN ISO 9000**

Calibration service for devices of other manufactures in air-conditioned laboratory at fixed prices.

- **Repair**

Repair service for electrical measurement instruments according to cost estimate or expense.

- **Safety check**

When the calibration or repair is completed, the device is tested according to §5 VBG 4.

- **Measurement instrument supervision**

If desired, we supervise the calibration deadlines for your measuring instruments to make sure they are kept.

- **Documentation**

Recording and archiving of all calibration data.

Our address:

GRUNDIG AG
Würzburger Str. 150
D-90766 Fürth

Calibration laboratory:

Tel. ++49 / (0) 911 - 977 955 05
Fax ++49 / (0) 911 - 977 955 07
e-mail: zs.kalibrierservice@grundig.com

Repair service:

Tel. ++49 / (0) 911 - 977 955 10
Fax ++49 / (0) 911 - 977 955 08
e-mail: zs.kom-hotline@grundig.com

or visit us in the Internet under www.grundig.com

Service Training Courses for our Customers

We train you in intensive courses in the GRUNDIG Central Service in Nuremberg as well as in one-day regional training courses.

We deal with all current questions on product technology in the fields of television, satellite reception, video and digital audio.

Our rooms are furnished for theoretical and hands-on training of 24 participants. Monitors are used to display measured values true to the detail and special measuring and adjustment procedures of the products the participants are to be trained on.

The suitable and modern equipment of measuring instruments makes it possible for the trainees to turn the theoretical knowledge gained directly into practical experience.



For detailed information on these courses please see the service training booklet which is available on request from your competent GRUNDIG contact partner, via Internet on our homepage www.grundig.de -> Produkte -> Händlerservice -> Service Schulungsprogramm 2003, or via "Infotip" button "Info" -> Service Schulungen 2003. There you also will find an enrolment form.

For inquiries do not hesitate to contact Mrs Lastinger Tel.: (0911) 703-8455

Fax-No.: (0911) 703-7732

We ask for your understanding that we can consider only applications in writing.

Privat Study with Service Training Manuals

The following training manuals can be ordered for private study against payment of a fee:

TV Engineering Service Training	Part No. D	Part No. GB
CUC 6360/6365/7300	72010 350 0000	-
Digi IV/ 100Hz Technique	72010 350 0500	-
Pal+ System Principles	72010 350 1000	-
Digi Basic	72010 350 1500	72010 350 1600
Digi Basic ++	72010 350 1700	72010 350 1800
Digi 6 / CUC 1842	72010 350 3000	72010 350 3100
CUC 2000/2010/2030/2050	72010 350 3500	72010 350 3600
Digi Basic 3	72010 350 3700	72010 350 3750
Planatron 2	72010 350 3800	72010 350 3900
Digi 100	72010 350 2100	72010 350 2200
CUC 2100/21xx	72010 350 3200	72010 350 3300
Chassis 12.5/12.6	72010 350 7000	72010 350 7100

Video Engineering Service Training	Part No. D	Part No. GB
GV 400 and variants	72010 525 1000	-
GV 500 and variants	72010 525 1500	-
GV 540/560 HiFi and variants	72010 525 2000	-
HSD Drive Mechanism	72010 525 2500	-
GV 640 and variants	72010 528 9000	72010 528 9100
GV 670-690	72010 528 9300	-
GV 900/940	72010 536 1500	-
GV 7000	72010 531 4000	72010 531 4100
GV 29..., GV 9000..., GV 9300..., GV 94...	72010 537 8000	-
GV 3000/5000/60xx	72010 537 1900	-
Principles of Digital-Video DV	72010 532 3500	-
MPEG Principles Digital-Video	72010 537 9000	-

Audio/HiFi Engineering: Service Training	Part No. D	Part No. GB
Principles of Audio Engineering	72010 749 5000	-
FM Tuner T11 / T1000	72010 749 5500	-
CD Player CD11 / CD12	72010 749 6000	-
DAB Principles	72010 749 6500	-

Video Training Film

Training film: High-speed Video Drive Mechanism HSDPart No.:72007 744 8100
 Dismantling and re-assembling the drive mechanism • replacement of wearing parts • replacement of the headwheel and the CTL head • adjustment of the tape transport path, tracking position and head gap position indicator • length approx. 30 minutes.

GRUNDIG

ISDN - InfoTip®

The common
Service Communication System in the
Entertainment Electronics Industry

GRUNDIG and members of the industrial association of entertainment electronics within the ZVEI (Central Association of the Electrotechnical Industry) offer the specialised dealers

"ISDN-InfoTip®"

as a future-orientated communication system.

Further information and quotation of prices are obtainable from:

InfoTip® Service GmbH • Marketing und Vertrieb
Postfach 510 213 • 44874 Bochum
Tel.: (0180) 567 30 42/43 (0,12€/min.) • Fax (0234) 941 10 02
e-mail: infotip@t-online.de or info@infotip.de
www.infotip.de

Grundig Universal Remote Controls



TV Control 1 Part No.: 72011 601 0000

replaces the following types:

Type	Code
TP Easy	102
TP 621	101
TP 622	101
TC 622	101
RC 622	101
TP 623	102
TP 661	103
RC 661	103
TP 661 Top	104
RC 661 Top	104
TP 661 Fasttext	104
TP 663	105
TP 911	103
TP 911 Top	104

and variants

Programming:
Press the Standby and OK buttons simultaneously. Release the buttons and enter the 3-digit code.



Video Control 1
Part No.: 72011 610 0000

replaces the following types:

Type	Code
RP 4	205
RP 6	201
RC 6	201
RP 50	205
VP 386	202
VP 615	206
RC 615	206

and variants

Programming:
 Press the Standby and OK buttons simultaneously. Release the buttons and enter the 3-digit code.



SAT Control 1
Part No.: 72011 620 0000

replaces the following types

Type	Code
TP DSR	302
RC SAT	301
RC 200 SAT	301
RC 201	301
RC 212	301
RC 300	301

and variants

Programming:
 Press the Standby and OK buttons simultaneously. Release the buttons and enter the 3-digit code.



Video Control LCD
Part No.: 72011 615 0000

replaces the following types:

Type	Code
RP 5 LCD	1
RP 6 LCD	1
RP 13 LCD	2
RP 20 LCD	3
RP 25 LCD	4
RP 30 LCD	5
RP 33 LCD	6
RP 35 LCD	6
RC 60 LCD	7
RP 65 LCD	1
RP 70 LCD	1
RC 70 LCD	1
RC 75 LCD	7
RP 75 LCD	7
RP 85 LCD	8
RP 90 LCD	7
RP 95 LCD	7
RP 130 LCD	2

and variants

Programming:

Insert battery -> SEL in display -> enter the code and confirm with OK.

The handling of the remote controls not mentioned before remains unchanged.

We recommend our dealers to build up appropriate stocks of these six types for immediate customer support in the case of repairs.

The remote controls are offered in a pleasing sales packing with all operating and coding information printed on it.

Pinning of Sockets and Plugs

Pinning of the EURO-AV Socket

The following table helps you to establish a standard connection of your television receiver to additional equipment on request (e.g. computer, amplifier).

Pin		Signal
1	=	Audio output right
2	=	Audio input right
3	=	Audio output left
4	=	Audio ground
5	=	Blue ground
6	=	Audio input left
7	=	RGB Blue input, chroma input/output with SVHS
8	=	Switching voltage 6V (16:9), 12V (4:3)
9	=	Green ground
10	=	Data lead MEGALOGIC
11	=	RGB Green input
12	=	Data
13	=	Red ground
14	=	Ground
15	=	RGB Red input, chroma input/output with SVHS
16	=	RGB switching voltage (1V Fastblanking)
17	=	Video ground
18	=	RGB switching voltage ground
19	=	CCVS output
20	=	CCVS / Y input
21	=	Shielding/ground

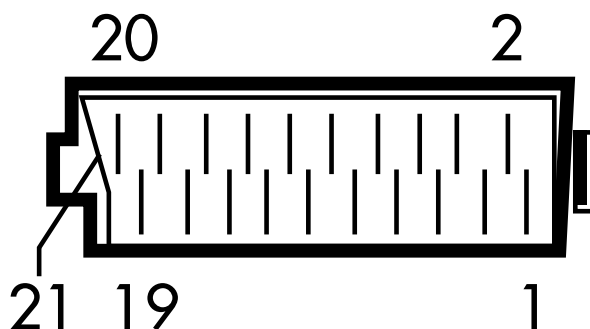

Pinning of Hosiden Socket (S-Video)

Pin		Signal
1	=	Ground
2	=	Ground
3	=	Y-signal
4	=	Chroma signal

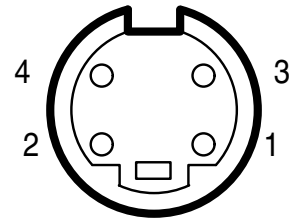

Top View

Pinning of DIN-AV Socket

Pin		Signal
1	=	Switching voltage on playback
2	=	CCVS signal
3	=	Ground
4	=	Audio left
5	=	Operating voltage for video adapter
6	=	Audio right

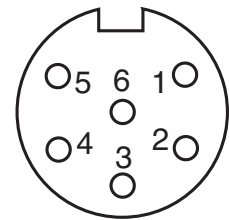

Top View

Pinning of DIN-Audio Socket

Pin		Signal
1	=	Record left and mono
2	=	Ground
3	=	Playback left and mono
4	=	Record left
5	=	Playback right

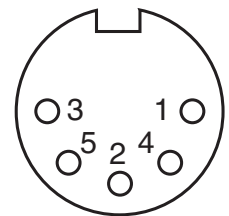

Top View

Pinning of Jack Plug

Pin		Signal
1	=	Ground
2	=	AF right
3	=	AF left



Pinning of ISO Standard Connector Blocks for Car Radios

I: Additional block (for Grundig products only)

Pin	=	Signal
1	=	TXD
2	=	RXD
3	=	+A CD changer
4	=	+U CDchanger
5	=	GND
6	=	GND
7	=	Line out FR
8	=	Line out RR
9	=	Line out FL
10	=	Line out RL

II: Loudspeaker connector block

Pin	=	Signal
1	=	RR+
2	=	RR-
3	=	FR+
4	=	FR-
5	=	FL+
6	=	FL-
7	=	RL+
8	=	RL-

III: Power supply connector block

Pin	=	Signal
1	=	SCV
2	=	Telephone mute
3	=	not used
4	=	Ignition (contact 15)
5	=	Automatic aerial
6	=	Illumination
7	=	+14V (contact 30)
8	=	GND

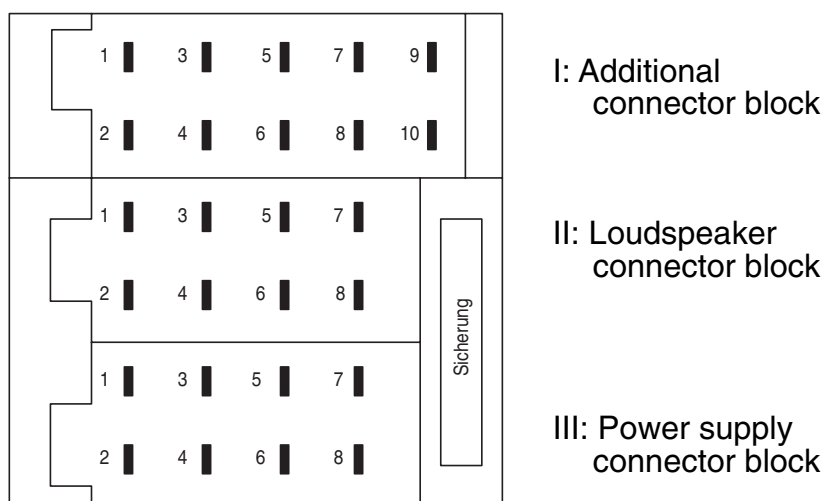

Pinning of ISO Standard Connector Blocks for Car Radios

I: Additional connector (for Grundig products only)

Pin	Signal
1	= Line out RL
2	= Line out RR
3	= Line out GND
4	= Line out FL
5	= Line out FR
6	= +Booster
7	= RXD
8	= TXD
9	= GND
10	= Subwoofer NF
11	= Aux IN
12	= Aux GND
13	= CD-bus
14	= not used
15	= CD-bus GND
16	= +A CD changer
17	= +U CD changer
18	= CD-NF GND
19	= CD-NF left
20	= CD-NF right

II: Loudspeaker connector block

Pin	Signal
1	= RR+
2	= RR-
3	= FR+
4	= FR-
5	= FL+
6	= FL-
7	= RL+
8	= RL-

III: Power supply connector block

Pin	Signal
1	= SCV
2	= Telephone mute
3	= not used
4	= Ignition (contact 15)
5	= Automatic aerial
6	= Illumination
7	= +14V (contact 30)
8	= GND

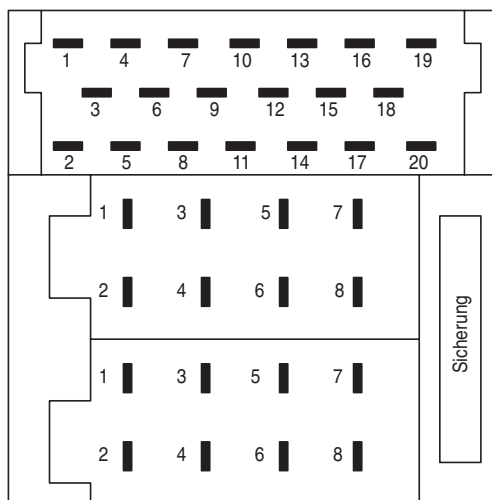

I: Additional connector block

II: Loudspeaker connector block

III: Power supply connector block

Top View

**TAE-plug (F-coded)
with integrated Western socket**

Standardized contact configuration
(TAE-plug)

- 1 --> A 4 --> E
 - 2 --> B 5 --> NC
 - 3 --> W2 6 --> NC
- (NC = not connected)

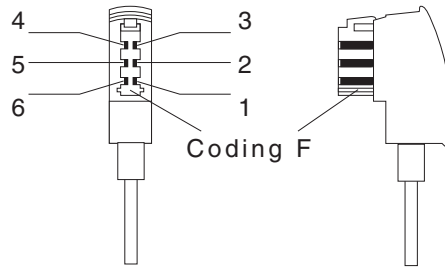

**TAE-plug (N-coded)
with integrated Western socket**

Standardized contact configuration
(TAE-plug)

- 1 --> A 4 --> E
- 2 --> B 5 --> B1
- 3 --> W2 6 --> A1

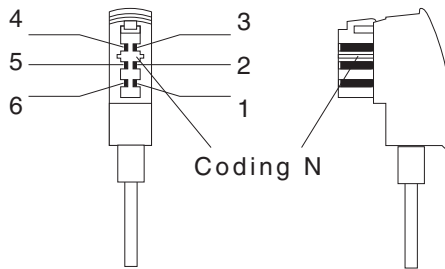

Connecting plug for Austrian variant

Contact configuration

- 1 --> A 6 --> B1
 - 2 --> E 7 --> NC
 - 3 --> W2 8 --> NC
 - 4 --> NC 9 --> NC
 - 5 --> B 10 --> A1
- (NC = not connected)

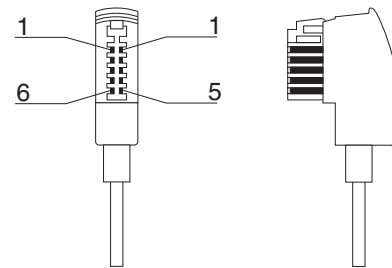

Connecting plug for French variant 1

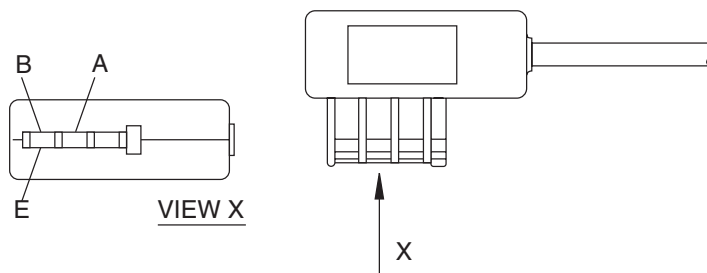

Connecting plug for French variant 2

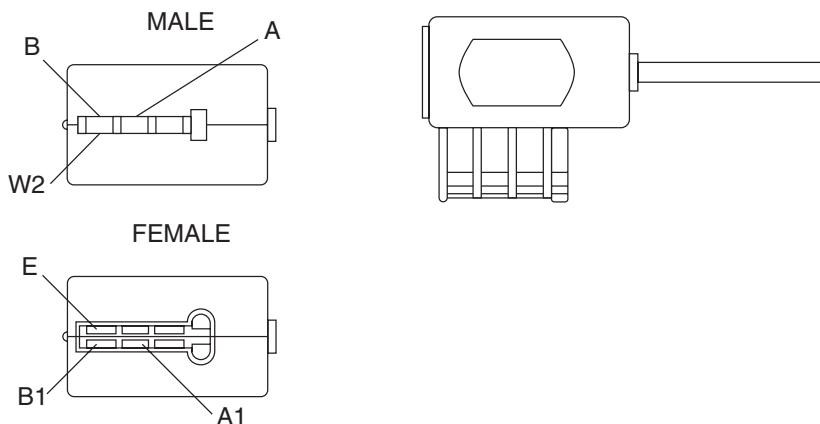

Connecting plug for Swiss variant



VIEW X

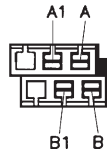

Connecting plug for Dutch variant

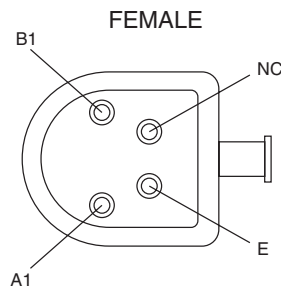
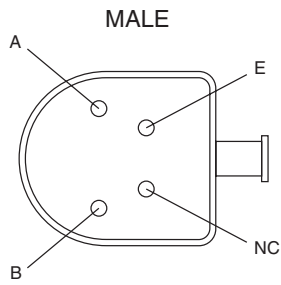
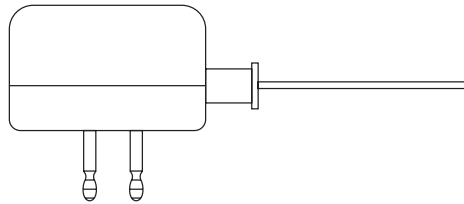

Connecting plug for Italian variant

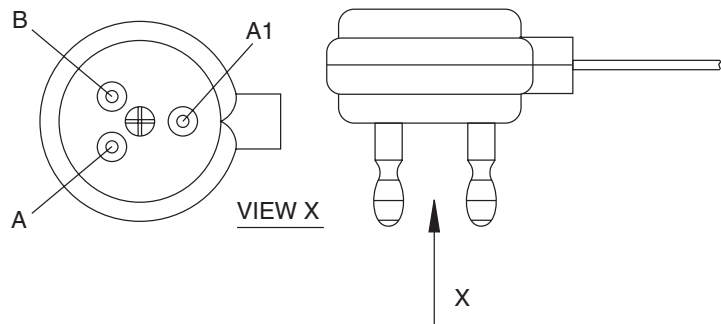

Connecting plug for Belgian Variant

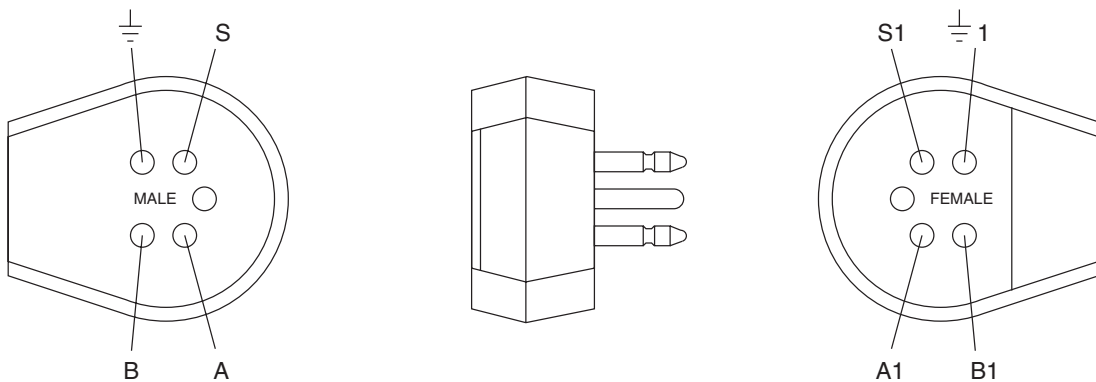

Contents: TV

Frequencies and Standards.....	2.2
Standards and Channels	2.3
Television Standards of the World	2.6
Special Channel Numbers/Frequencies	2.10
Hyperband in Germany.....	2.11
Channel Overview	2.12
Handling of the Sets Chart.....	2.13
Module Coding for the Sets Chart	2.14
Sets Chart.....	2.17
Tele-Pilot® Remote Control Handsets / Overview.....	2.69
Special Functions of Colour Television Receivers:	
Sets with Chassis Digi 100	
CUC 1807/1837/1838/1839/1934/1935	2.72
Sets with Chassis CUC 2000	
CUC 2003/2005/2020/2021/2030/2031/2032/2033	
CUC 2035/2036/2040/2050/2051/2058/2059/2080	2.74
Sets with Chassis CUC 2100	
CUC 2100/2103/2105/2121/2130	2.76
Sets with Chassis Digi 6	
CUC 1842/1894/1952/1983/1984	2.78
Sets with Chassis Digi Basic / Digi Basic +	
CUC 1805/1825/1826	2.81
Sets with Chassis Digi Basic ++	
CUC 1806/1828/1829/1830/1836/1929	2.83
Sets with Chassis Digi Basic 3	
CUC 1832/1930/1931	2.86
Sets with Chassis 12.5.....	2.89
Geräte mit Chassis 12.6.....	2.89
Sets with CUC 7303 / 7305.....	2.90
Sets with CUC 7350.....	2.91
Service Manuals:	
- sorted by TV sets.....	2.92
- sorted by chassis.....	2.127

To be better readable part numbers are shown with two spaces.
 For ordering spare parts please indicate part numbers as **twelve-figure number** without spaces.

Frequencies and Standards

Allocation of Frequencies

151 - 285 kHz	2001 - 1050 m	Long Wave
536 - 1605 kHz	560 - 189 m	Medium Wave
5,95 - 26,1 MHz	50 - 11,5 m	Short Wave
41 - 68 MHz	Channel Width 7 MHz	VHF-TV Band I
87,5 - 108 MHz	Channel Width 100 kHz	VHF-UKW Band II
174 - 223 MHz	Channel Width 7 MHz	VHF-TV Band III
470 - 606 MHz	Channel Width 8 MHz	UHF-TV Band IV
606 - 854 MHz	Channel Width 8 MHz	UHF-TV Band V

General Television Standards

Standard	Lines	Channel Width in MHz	Video Band-width in MHz	Vision/Sound Spacing in MHz	Residual Side-band in MHz	Colour Sub-carrier in MHz (PAL)	Vision Modulation	Sound Modulation
A	405	5	3	-3,5	0,75	-	Pos	AM
B	625	7	5	+ 5,5	0,75	4,43	Neg	FM
C	625	7	5	+ 5,5	0,75	4,43	Pos	AM
D	625	8	6	+ 6,5	0,75	-	Neg	FM
E	819	14	10	+ 11,15	2	-	Pos	AM
F	819	7	5	+ 5,5	0,75	-	Pos	AM
G	625	8	5	+ 5,5	0,75	4,43	Neg	FM
H	625	8	5	+ 5,5	1,25	4,43	Neg	FM
I	625	8	5,5	+ 6,0	1,25	4,43	Neg	FM
K	625	8	6	+ 6,5	0,75	4,43	Neg	FM
K'	625	8	6	+ 6,5	1,25	4,43	Neg	FM
L	625	8	6	+ 6,5	1,25	4,43	Pos	AM
M	525	6	4,2	+ 4,5	0,75	3,576 *)	Neg	FM
N	625	6	4,2	+ 4,5	0,75	3,582	Neg	FM

50 Hz field frequency, 60 Hz only Standard M *) NTSC = 3.579 MHz

Band IV/V - European and African Standards

(only 625 lines, channel bandwidth 8 MHz)

Standard	Video Band-width MHz	Vision/Sound Spacing MHz	Residual Side-band MHz	Vision Modulation	Sound Modulation MHz	Colour Sub-carrier	Picture/Sound Radio
G	5	5,5	0,75	Neg	FM	4,43	5:1
H	5	5,5	1,25	Neg	FM	4,43	5:1
I	5,5	6	1,25	Neg	FM	4,43	5:1
K	6	6,5	0,75	Neg	FM	4,43	5:1
L	6	6,5	1,25	Pos	AM	4,43	8:1

Satellite Bands

Designation	Frequency Range GHz
C-Band	3,6-4,2
Ku-Bands	10,7-12,75

Standards and Channels

Standard A

	Picture MHz	Sound MHz		Picture MHz	Sound MHz
Ch 1	45,0	41,5	Ch 7	184,75	181,25
Ch 2	51,75	48,25	Ch 8	189,75	186,25
Ch 3	56,75	53,25	Ch 9	194,75	191,25
Ch 4	61,75	58,25	Ch 10	199,75	196,25
Ch 5	66,75	63,25	Ch 11	204,75	201,25
Ch 6	179,75	176,25	Ch 12	209,75	206,25

Standard B/C/F/G

	Picture MHz	Sound MHz		Picture MHz	Sound MHz
Band I			Ch 37	599,25	604,75
Ch 1	46,25	51,75	Ch 38	607,25	612,75
Ch 2	48,25	53,75	Ch 39	615,25	620,75
Ch 3	55,25	60,75	Ch 40	623,25	628,75
Ch 4	62,25	67,75	Ch 41	631,25	636,75
Band III			Ch 42	639,25	644,75
Ch 5	175,25	180,75	Ch 43	647,25	652,75
Ch 6	182,25	187,75	Ch 44	655,25	660,75
Ch 7	189,25	194,75	Ch 45	663,25	668,75
Ch 8	196,25	201,75	Ch 46	671,25	676,75
Ch 9	203,25	208,75	Ch 47	679,25	684,75
Ch 10	210,25	215,75	Ch 48	687,25	692,75
Ch 11	217,25	222,75	Ch 49	695,25	700,75
Ch 12	224,25	229,75	Ch 50	703,25	708,75
Band IV/V acc. to Standard H			Ch 51	711,25	716,75
Ch 21	471,25	476,75	Ch 52	719,25	724,75
Ch 22	479,25	484,75	Ch 53	727,25	732,75
Ch 23	487,25	492,75	Ch 54	735,25	740,75
Ch 24	495,25	500,75	Ch 55	743,25	748,75
Ch 25	503,25	508,75	Ch 56	751,25	756,75
Ch 26	511,25	516,75	Ch 57	759,25	764,75
Ch 27	519,25	524,75	Ch 58	767,25	772,75
Ch 28	527,25	532,75	Ch 59	775,25	780,75
Ch 29	535,25	540,75	Ch 60	783,25	788,75
Ch 30	543,25	548,75	Ch 61	791,25	796,75
Ch 31	551,25	556,75	Ch 62	799,25	804,75
Ch 32	559,25	564,75	Ch 63	807,25	812,75
Ch 33	567,25	572,75	Ch 64	815,25	820,75
Ch 34	575,25	580,75	Ch 65	823,25	828,75
Ch 35	583,25	588,75	Ch 66	831,25	836,75
Ch 36	591,25	596,75	Ch 67	839,25	844,75
			Ch 68	847,25	852,75
			Ch 69	855,25	860,75

Standard D *)

	Picture MHz	Sound MHz		Picture MHz	Sound MHz
Ch 1	49,75	56,25	Ch 7	183,25	189,75
Ch 2	59,25	65,75	Ch 8	191,25	197,75
Ch 3	77,25	83,75	Ch 9	199,25	205,75
Ch 4	85,25	91,75	Ch 10	207,25	213,75
Ch 5	93,25	99,75	Ch 11	215,25	221,75
Ch 6	175,25	181,75	Ch 12	223,25	229,75

*) UHF channels and vision carriers like Standard B, vision to sound carrier spacing + 6,5 MHz each

Standard E

	Picture MHz	Sound MHz		Picture MHz	Sound MHz
Ch 2	52,4	41,25	Ch 8	185,25	174,1
Ch 4	65,55	54,4	Ch 8A	186,55	175,4
Ch 5	164	175,15	Ch 9	190,3	201,45
Ch 6	173,4	162,25	Ch 10	199,7	188,55
Ch 7	177,15	188,3	Ch 11	203,45	214,6
			Ch 12	212,85	201,7

Standard I

	Picture MHz	Sound MHz		Picture MHz	Sound MHz
A	45,75	51,75			
B	53,75	59,75			
C	61,75	67,75	Ch 21	Band IV/V 471,25	477,25
D	175,25	181,25	Ch 22		479,25
E	183,25	189,25			
F	191,25	197,25		up to *	
G	199,25	205,25			
H	207,25	213,25	Ch 67	839,25	845,25
I	215,25	221,25	Ch 68	847,25	853,25

*Channel allocation and vision carriers like Standard B. Vision to sound carrier spacing + 6 MHz each.

Standard K' (French overseas territories)

	Picture MHz	Sound MHz		Picture MHz	Sound MHz
Ch 4	175,25	181,75	Ch 7	199,25	205,75
Ch 5	183,25	189,75	Ch 8	207,25	213,75
Ch 6	191,25	197,75	Ch 9	215,25	221,75

Standard M/N

	Picture MHz	Sound MHz		Picture MHz	Sound MHz
Ch 1	-	-	Ch 8	181,25	185,75
Ch 2	55,25	59,75	Ch 9	187,25	191,75
Ch 3	61,25	65,75	Ch 10	193,25	197,75
Ch 4	67,25	71,75	Ch 11	199,25	203,75
Ch 5	77,25	81,75	Ch 12	205,25	209,75
Ch 6	83,25	87,75	Ch 13	211,25	215,75
Ch 7	175,25	179,75	Ch 14	471,25	475,75
			Ch 83	continually up to 885,25	889,75

Channel Allocation - Italy (otherwise Standard B)

	Picture MHz	Sound MHz		Picture MHz	Sound MHz
A	53,75	59,25	E	183,25	189,75
B	62,25	67,75	F	192,25	197,75
C	82,25	87,75	G	201,25	206,75
D	175,25	180,75	H	210,25	215,75
			H 1	217,25	222,75

Channel Allocation - Morocco (otherwise Standard B)

	Picture MHz	Sound MHz		Picture MHz	Sound MHz
M 4	163,25	168,75	M 8	195,25	200,75
M 5	171,25	176,75	M 9	203,25	208,75
M 6	179,25	184,75	M 10	211,25	216,75
M 7	187,25	192,75			

Channel Allocation - Australia (otherwise B)

	Picture MHz	Sound MHz		Picture MHz	Sound MHz
Ch 0	46,25	51,75	Ch 6	175,25	180,75
Ch 1	57,25	62,75	Ch 7	182,25	187,75
Ch 2	64,25	69,75	Ch 8	189,25	194,75
Ch 3	86,25	91,75	Ch 9	196,25	201,75
Ch 4	95,25	100,75	Ch 10	209,25	214,75
Ch 5	102,25	107,75	Ch 11	216,25	221,75
Ch 5A	138,25	143,75			

Channel Allocation - New Zealand (otherwise Standard B)

	Picture MHz	Sound MHz		Picture MHz	Sound MHz
Ch 1	45,25	50,75	Ch 6	189,25	194,75
Ch 2	55,25	60,75	Ch 7	196,25	201,75
Ch 3	62,25	67,75	Ch 8	203,25	208,75
Ch 4	175,25	180,75	Ch 9	210,25	215,75
Ch 5	182,25	187,75			

Channel Allocation - Japan (otherwise Standard M)

	Picture MHz	Sound MHz		Picture MHz	Sound MHz
Ch 1	91,25	95,75	Ch 10	205,25	209,75
Ch 2	97,25	101,75	Ch 11	211,25	215,75
Ch 3	103,25	107,75	Ch 12	217,25	221,75
Ch 4	171,25	175,75			
Ch 5	177,25	181,75	Ch 33	591,25	595,75
Ch 6	183,25	187,75			
Ch 7	189,25	193,75			
Ch 8	193,25	197,75			
Ch 9	199,25	203,75	Ch 62	765,25	769,75

Television Standards of the World (as far as known to us)

with indication of the mains voltage and mains frequency

Country	b/w	Colour	Mains Voltage Volt	Mains Frequency Hz
Afghanistan	B	PAL	220	50
Albania	B/G	PAL	220	50
Algeria	B/H	PAL	127-220	50
Andorra	B/G	PAL	220	50
Angola	I	PAL	220	50
Antigua and Barbuda	M	NTSC	230	50
Argentina	N 1)	PAL-N	220	50
Armenia	D/K	SECAM (B/Z)	220	50
Australia	B/G	PAL	240	50
Austria	B/G	PAL	220	50
Azerbaijan	D/K	SECAM (B/Z)	220	50
Azores (Portugal)	B	PAL	220	50
Bahamas	M	NTSC	120	60
Bahrain	B	PAL	230	50-60
Bangladesh	B	PAL	220-230	50
Barbados	M	NTSC	110-220	50
Belarus	D/K	SECAM (B/Z)	220	50
Belgium	B/G	PAL	220	50
Belize	M	NTSC	110-220	60
Benin	K´	SECAM	220	50
Bermuda (Großbritannien)	M	NTSC	115-120	60
Bhutan			220	50
Bolivia	N	NTSC	115-230	50-60
Bosnia and Herzegovina	B,H	PAL	220	50
Botswana	I 1)	PAL	220	50
Brazil	M	PAL-M	220	60
Brunei Darussalam	B	PAL	230	50
Bulgaria	D	SECAM	220	50
Burkina Faso	K´	SECAM	220	50
Burundi	K1	SECAM	220	50
Cambodia	B/G	PAL	120-220	50
Cameroon	B/G	PAL	127-220	50
Canada	M	NTSC	120	60
Canary Islands (Spain)	B	PAL	127-220	50
Cape Verde			220	50
Central African Republic	K	SECAM	220	50
Chile	M	NTSC	220	50
China	D	PAL	220	50
CIS States (former)	D/K	SECAM (B/Z)	127-220	50
Colombia	M	NTSC	120	60
Comoros			220	50
Congo, Democratic Republic of	K´	SECAM	220	50
congo, Republic of the	K´	SECAM	220	50
Costa Rica	M	NTSC	120	60
Côte d'Ivoire	K´	SECAM (B)	220	50
Croatia	B/G	PAL	220	50
Cuba	M	NTSC	115-120	60
Cyprus	B/G	SECAM (Z) + PAL	240	50
Czech Republic	D/K	PAL/SECAM	220	50
Denmark	B/G	PAL	220	50
Djibouti	K´	SECAM	220	50
Dominica	M	NTSC	230	50
Dominican Republic	M	NTSC	110	60
Ecuador	M	NTSC	110-220	60
Egypt	B/H	SECAM	110-220	50

1) Channels are differing! (B) = Field identification (Z) = Line identification

Country	b/w	Colour	Mains Voltage Volt	Mains Frequency Hz
El Salvador	M	NTSC	115	60
Equatorial Guinea	B	PAL	220	50
Eritrea	B	PAL	220	50
Estonia	D/K	SECAM (B/Z)	220	50
Ethiopia	B/G	PAL	220	50
Fiji	B	PAL	240	50
Finland	B/G	PAL	230	50
France	E/L	SECAM (Z)	220	50
Gabon	K'	SECAM	220	50
Gambia			220	50
Georgia	D/K	SECAM (B/Z)	220	50
Germany	B/G	PAL	230	50
Ghana	B	PAL	220	50
Gibraltar (United Kingdom)	B/H	PAL	240	50
Greece	B/H	PAL	220	50
Greenland (Denmark)	M	NTSC	220	50
Grenada	M	NTSC		
Guadeloupe (France)	K'	SECAM	220	50
Guatemala	M	NTSC	110-220	60
Guinea Rep.	K'	SECAM	220	50
Guinea-Bissau			220	50
Guyana (franc.)	K'	SECAM	220	50
Haiti	M	NTSC	110-220	50-60
Hawaii (US)	M	NTSC	120	60
Holy See (Vatican City)			220,127	50
Honduras	M	NTSC	110-220	60
Hong Kong (China)	I	PAL	220	50
Iceland	B	PAL	220	50
India	B	PAL	220	50
Indonesia	B	PAL	220	50
Iran	H	SECAM	220	50
Iraq	B	SECAM (Z)	220	50
Ireland (Rep.)	I	PAL	220	50
Israel	B/G	PAL	230	50
Italy	B/G	PAL	127-220	50
Jamaica	N	SECAM	220	50
Japan	M 1)	NTSC	100-200	50/60
Jordan	B	PAL	220	50
Kazakhstan	D/K	SECAM (B/Z)	220	50
Kenya	B	PAL	240	50
Kiribati			240	50
Korea (North)	D	SECAM	100-200	50
Korea (South)	M	NTSC	220	60
Kuwait	B/G	PAL	240	50
Kyrgyzstan	D/K	SECAM (B/Z)	220	50
Laos	M	PAL	127-220	50
Latvia	D/K	SECAM (B/Z)	220	50
Lebanon	B	SECAM (Z)	110-220	50
Lesotho	I	PAL	220	50
Liberia	B	PAL	120	60
Libya	B/H	SECAM (Z)	127-230	50
Liechtenstein			220	50
Lithuania	D/K	SECAM (B/Z)	220	50
Luxembourg	B/G	PAL	120-220	50
Macedonia, The former Yugoslav Rep. of	B,H	PAL	220	50

1) Channels are differing! (B) = Field identification (Z) = Line identification

Country	b/w	Colour	Mains Voltage Volt	Mains Frequency Hz
Madagascar	B	SECAM	127-220	50
Madeira (Portugal)	B	PAL	220	50
Malawi	B,G	PAL	230	50
Malaysia	B	PAL	240	50
Maldives	B	PAL	230	50
Mali	K	SECAM	220	50
Malta	B/G	PAL	240	50
Marshall Islands	M	NTSC	110	60
Martinique (France)	K'	SECAM (B)	220	50
Mauritania	K'	SECAM	220	50
Mauritius	B	SECAM	230	50
Mexico	M	NTSC	120	60
Micronesia, Federated States of	M	NTSC	110	60
Moldova	D/K	SECAM (B/Z)	220	50
Monaco	L/G	PAL/SECAM (B/Z)	127-220	50
Mongolia	D	SECAM (B/Z)	220	50
Morocco	B	SECAM (B)	115-230	50
Mozambique	B	PAL	220	50
Myanmar	M	NTSC	220	50
Namibia	I	PAL	230	50
Nauru			220	50
Nepal	B	PAL	220	50
Netherlands	B/G	PAL	220	50
Netherlands Antilles (Netherlands)	M	NTSC	115-223	50-60
New Caledonia (France)	K'	SECAM	220	50
New Zealand	B1)	PAL	240	50
Nicaragua	M	NTSC	120	60
Niger	K'	PAL	220	50
Nigeria	B/I	PAL	230	50
Norway	B/G	PAL	230	50
Oman	B/G	PAL	220	50
Pakistan	B	PAL	220-230	50
Palau	M	NTSC	110,115	60
Panama	M	NTSC	120	60
Papua New Guinea	B,G	PAL	240	50
Paraguay	N	PAL	220	50
Peru	M	NTSC	220	60
Philippines	M	NTSC	220	60
Poland	D/K	PAL	220	50
Portugal	B/G	PAL	220	50
Puerto-Rico (US)	M	NTSC	120	60
Qatar	B	PAL	240	50
Romania	G	PAL	220	50
Russia	D/K	SECAM (B/Z)	220	50
Rwanda	K'	PAL/SECAM	220	50
Salomon Islands				
Samoa	M	NTSC	230	50
San Marino			127	50
São Tomé und Príncipe			220	50
Saudi Arabia	B	SECAM (Z)	220	50-60
Senegal	K'	SECAM	127-220	50
Seychelles	B	PAL	240	50
Sierra Leone	B	PAL	220	50
Singapore	B	PAL	230	50
Slovakia	D/K	PAL	220	50

1) Channels are differing! (B) = Field identification (Z) = Line identification

Country	b/w	Colour	Mains Voltage Volt	Mains Frequency Hz
Slovenia	B/G	PAL	220	50
Somalia	B/G	PAL	110-230	50
South Africa	I1)	PAL	230	50
Spain	B/G	PAL	127-220	50
Sri Lanka	B/G	PAL	220	50
St. Kitts and Nevis				
St. Lucia				
St. Pierre and Miquelon (France)	K/I	SECAM		
St. Vincent and the Grenadines				
Sudan	B	PAL	240	50
Suriname	M	NTSC	110-127	60
Swaziland	B/G	PAL	230	50
Sweden	B/G	PAL	220	50
Switzerland	B/G	PAL	220	50
Syria	B	PAL	115-220	50
Tahiti (France)	K'	SECAM	120-240	60
Taiwan	M	NTSC	120	60
Tajikistan	D/K	SECAM (B/Z)	220	50
Tanzania	B	PAL	230	50
Thailand	B	PAL	220	50
Togo	K'	SECAM	127-220	50
Tonga			240	50
Trinidad and Tobago	M	NTSC	115-230	60
Tschad	K'	SECAM	220	50
Tunisia	B	SECAM	127-220	50
Turkey	B	PAL	220	50
Turkmenistan	D/K	SECAM (B/Z)	220	50
Tuvalu			240	50
Uganda	B/G	PAL	240	50
Ukraine	D,K	SECAM	220	50
Ungary	D/K + B/G	PAL	220	50
United Arab. Emirates	B/G	PAL	220-240	50
United Kingdom	A/I	PAL	210-240	50
United States	M	NTSC	110	60
Uruguay	N	PAL	220	50
Uzbekistan	D/K	SECAM (B/Z)	220	50
Vanuatu				
Venezuela	M	NTSC	120	60
Vergin Islands (US)	M	NTSC	120	60
Vietnam	D/M	NTSC/SECAM	120-230	50
Yemen	B	PAL	220	50
Yugoslavia (former)	B	PAL	220	50
Zambia	B	PAL	220	50
Zanzibar (Tanzania)	I	PAL	230	50
Zimbabwe	B/G	PAL	220	50

1) Channels are differing! (B) = Field identification (Z) = Line identification

Notes:

1. For countries where several mains voltage levels are applicable because of regional differences, the lowest and highest value is given.
2. Two mains frequencies are stated for countries where two frequencies are possible.

Important for the Selection of Special Channels with non-directly indicating Colour TVs and VCRs with Frequency Synthesizer and Cable Tuner

All German-language transmitters (Federal Republic of Germany, Austria) are directly indicated with their channel numbers. Exceptions may exist for transmitters which are converted into other frequency ranges by converters (e.g. reception by cable). The table given below shows the allocation of the channel numbers to special channels of public cable television systems.

Channel No. Indication	Special Channel	Vision Carrier Frequency (MHz)	Band
81	S 1	105,25	Lower Special Channel Band "USB"
82	S 2	112,25	
83	S 3	119,25	
84	S 4	126,25	
85	S 5	133,25	
86	S 6	140,25	
87	S 7	147,25	
88	S 8	154,25	
89	S 9	161,25	
90	S 10	168,25	
91	S 11	231,25	Upper Special Channel Band "OSB"
92	S 12	238,25	
93	S 13	245,25	
94	S 14	252,25	
95	S 15	259,25	
96	S 16	266,25	
97	S 17	273,25	
98	S 18	280,25	
99	S 19	287,25	
00	S 20	294,25	
74		69,25	Special Channel Band Belgium
75		76,25	
76		83,25	
77		90,25	
78		97,25	
79		59,25	OIRT Channels
80		93,25	

Hyperband in Germany

GRUNDIG television receivers fitted with the Tuner 29504 101 0100/0600 can receive the Hyperband channels S21 - S25 only by means of a hyperband converter. This converter can be obtained from:

Elektronik Thoma GmbH, Friedhofweg 5, D-91599 Dentlein,
Tel. ++49 9855/9777-0 FAX 09855/977720

Special Channel	8 MHz Channels		12 MHz Channels	Band
	Vision Carrier (MHz)	Sound Carrier(MHz)	Carrier	
S 21	303,25	308,75	303,25	Extended Special Channel Band "ESB"
S 22	311,25	316,75	315,25	
S 23	319,25	324,75	327,25	
S 24	327,25	332,75	339,25	
S 25	335,25	340,75	351,25	
S 26	343,25	348,75	363,25	
S 27	351,25	356,75	375,25	
S 28	359,25	364,75	387,25	
S 29	367,25	372,75	399,25	
S 30	375,25	380,75	411,25	
S 31	383,25	388,75	423,25	
S 32	391,25	396,75	435,25	
S 33	399,25	404,75	447,25	
S 34	407,25	412,75	459,25	
S 35	415,25	420,75		
S 36	423,25	428,75		
S 37	431,25	436,75		
S 38	439,25	444,75		
S 39	447,25	452,75		
S 40	455,25	460,75		
S 41	463,25	468,75		

Subject to alterations!



Channel Overview

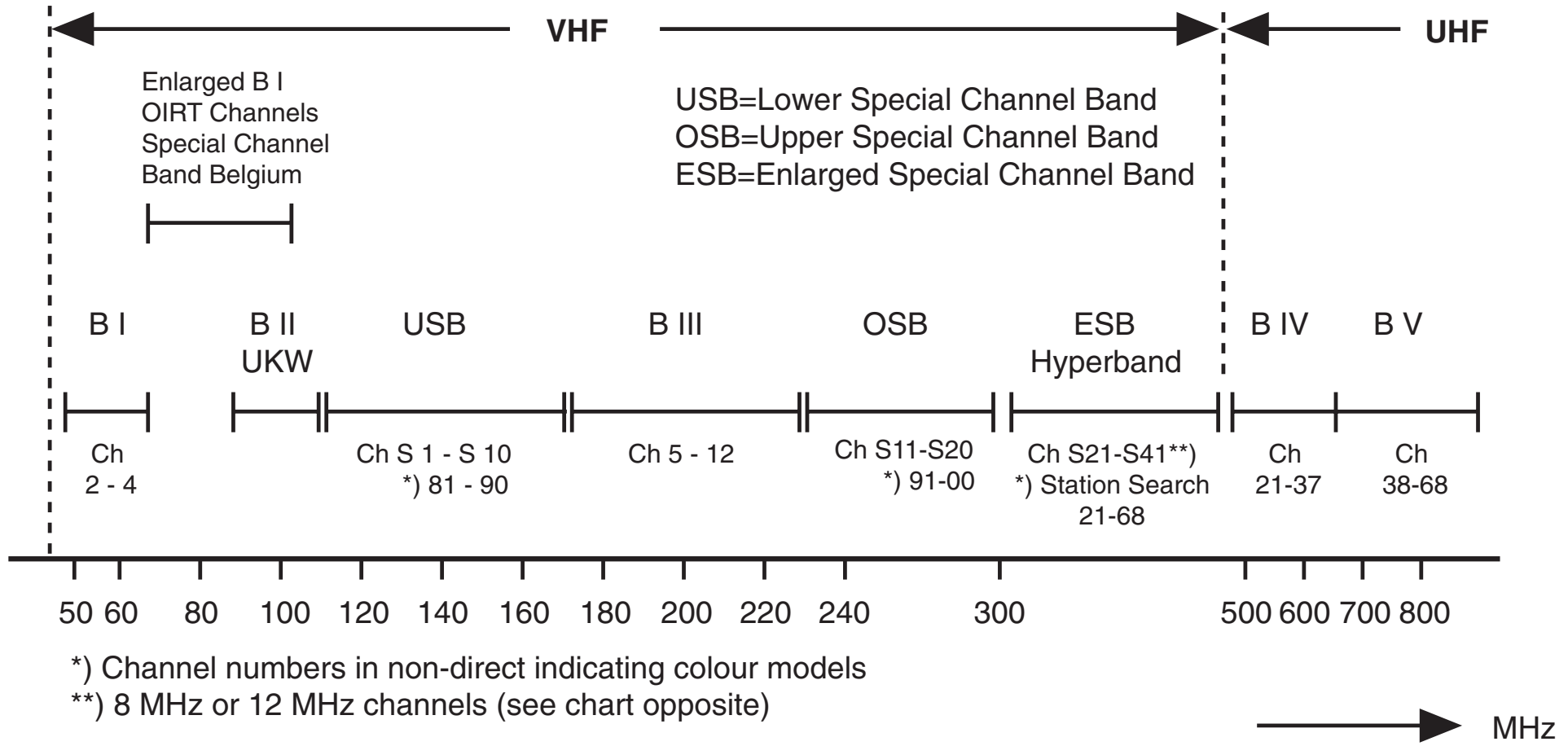

Module Coding for the Sets Chart (from Page 17 on)

Control Units

04	29501 082 1300
09	29501 082 5900
10	29501 082 6100
11	29501 082 6200
12	29501 082 7000
13	29501 082 7600
14	29501 082 7900
15	29501 082 8100
16	29501 082 8200
17	29501 082 8800
18	29501 085 0100
19	29501 085 0200
20	29501 085 0400
21	29501 085 0800
22	29501 085 1200
23	29501 085 0700
24	29501 082 7500
25	29501 082 8300
26	29501 085 1800
27	29501 085 1600
28	29501 085 3600
29	29501 085 1300
30	29501 085 1900
31	29501 085 2200
32	29501 085 2500
33	29501 085 3200
34	29501 085 1400
35	29501 085 2900
36	29501 085 4500
37	29501 085 4000
38	29501 085 4200
39	29501 085 4400
40	29501 085 5600
41	29501 085 5900
42	29501 085 6000
43	29501 085 4300
44	29501 085 5100
45	29501 085 3400
46	29501 085 3900
47	29501 085 5800
48	29501 085 4800
49	29501 085 6600
50	29501 085 6200
51	29501 085 6700
52	29501 085 5200
53	29501 085 4900
54	29501 085 4700
55	29501 085 7200
56	29305 311 1100
57	29501 085 4100
58	29501 085 5700
59	29501 085 5400
60	29501 085 7400

CRT Panels

04	29305 022 1400
05	29305 022 1500
06	29305 022 1600
07	29305 022 1700
08	29305 022 1900
09	29305 022 2000
20	29305 022 8700
21	29305 022 8800
22	29305 022 9000
26	29305 122 0400
29	29305 122 0700
30	29305 122 1000
33	29305 122 1400
34	29305 122 1500
35	29305 122 1600
36	29305 122 1700
38	29305 122 1900
39	29305 122 2000
40	29305 122 2100
41	29305 122 2300
42	29305 122 2400
43	29305 122 2500
44	29305 122 2600
45	29305 122 2800
46	29305 122 3000
47	29305 022 1800
48	29305 122 2900
49	29305 122 3100
50	29305 122 3400
51	29305 122 3600
52	29305 122 3800
53	29305 122 3300
54	29305 122 3500
55	29305 122 3700
56	29305 122 4000
57	29305 122 3900
58	29305 122 3200
59	29305 122 4100
60	29305 122 4500
61	29305 122 4300
62	29305 122 4600
63	29305 122 4400
64	29305 122 4900
65	29305 122 4200

Keyboards

01	29501 081 8500
03	29501 083 0200
04	29501 083 0400
05	29501 083 2400
06	29501 083 2500
07	29501 083 2500
08	29501 083 4400
09	29501 083 7000
10	29501 083 8000
11	29501 083 8200
12	29501 083 8300
13	29501 084 0700
14	29501 084 0500
15	29501 084 0800
16	29501 084 0400
17	29501 083 2600
18	29305 311 1100
19	29501 084 0900

Socket Boards

03	29305 008 3600
04	29305 008 3700
05	29305 008 3800
06	29305 008 4000
07	29305 008 4100
08	29305 008 8300
12	29305 160 3400
13	29305 160 6000
14	29305 160 6300
15	29305 160 5400
16	29305 160 5300
17	29305 008 4300
18	29305 008 4400
19	29305 160 3700
20	29305 008 4600
21	29305 008 4800
22	29305 008 4500
23	29305 008 5000
24	29305 008 5100
25	29305 160 3800
26	29305 160 6600
27	29305 160 5400
28	29305 160 3900
29	29305 160 4200
30	29305 008 5600
31	29305 008 5500
32	29305 160 5700
33	29305 304 0100
34	29305 304 0300
35	29305 304 0400
36	29305 008 5200
37	29305 008 6200

Feature Boxes

04	29504 103 3700
05	29504 103 3800
06	29504 103 3900
07	29504 103 4100
08	29504 103 4200
09	29504 103 4400
10	29504 209 0100
11	29504 209 0200
12	29504 209 0300
13	29504 209 0500
14	29504 209 0400
15	29504 209 1300
16	29504 209 1500
17	29504 209 0900
18	29504 203 2100
19	29504 203 2200
20	29504 203 4200
21	29504 203 4100
22	29504 203 2300
23	29504 203 4300
24	29504 203 4500
25	29504 203 2800
26	29504 203 4600
27	29504 203 2500
28	29504 203 3200
29	29504 203 3100
30	29305 301 0200
31	29504 203 2900
32	29504 203 6100
33	29504 203 6200

Mains Switch Boards

01	29305 165 1900
02	29305 165 6400
03	29305 165 6800
04	29305 165 7100
05	29305 165 7300
06	29305 165 7600
07	29305 165 8100
08	29305 165 8200
09	29305 165 8300
10	29305 165 8400
11	29305 165 7500
12	29305 165 8700
13	29305 165 9000
14	29305 165 9100
15	29305 165 9200
16	29305 165 7700
17	29501 087 0300
18	29501 087 0800
19	29501 087 0900
20	29501 087 1200
21	29305 087 0500
22	29501 087 1000
23	29501 087 1600
24	29501 087 1700
25	29501 087 2000
26	29501 087 2100
27	29501 087 1100
28	29501 087 2200
29	29305 311 2100
30	29501 087 0700
31	29501 087 1400
32	29501 087 1300
33	29501 087 1800
34	29501 087 2600
35	29501 087 2700

EPG Boards

01	29305 129 0300
02	29305 129 1100
03	29305 129 0900

AF Modules

01	29504 102 8100
02	29504 102 8200
06	29504 104 4100
07	29504 104 4200
08	29504 104 4300
18	29504 104 7700
19	29504 104 8100
20	29504 104 8200
22	29504 104 8400
23	29504 104 8500
24	29504 204 0100
25	29504 204 0300
26	29504 204 0400
27	29504 204 0500
28	29504 204 0600
29	29504 102 8300
30	29504 102 8400
31	29504 204 1300
32	29504 204 1400
33	29504 204 1500
34	29504 204 1600
35	29504 102 8500
36	29504 102 8600
37	29305 309 0100

East/West Boards

08	29504 207 5100
09	29504 207 5200
10	29504 207 5500
11	29504 207 5700
12	29504 107 5800
13	29504 207 5900
14	29504 207 5300
15	29504 207 5400
16	29504 207 5600

Processor Panels

01	29305 119 7100
02	29305 219 0200
03	29305 219 0300
04	29305 219 0600
05	29305 219 0700
06	29305 219 1300
07	29305 319 0300
08	29504 203 0100
09	29504 203 0200
10	29504 203 0400
11	29504 203 0600
12	29504 203 0800
13	29504 203 0900
14	29305 319 0100
15	29305 319 0200
16	29504 203 0500
17	29504 203 0700
18	29504 203 1600
19	29305 219 1400
20	29504 203 1400
21	29504 203 1700
22	29305 219 1600
23	29305 219 1700
24	29305 219 2500
25	29305 219 2600
26	29305 219 2400
27	29305 219 2700
28	29504 203 1800
29	29305 219 2100
30	29305 219 3000
31	29305 219 3700
32	29305 219 3800
33	29305 219 2800
34	29305 219 8100
35	29305 219 4100
36	29305 219 4200
37	29305 219 4500
38	29305 219 4300
39	29305 219 3300

PIP Modules

01	29504 106 5100
02	29504 106 5200
03	29504 106 5300
04	29504 106 5400
07	29504 165 9700
08	29504 165 9800
09	29504 206 0100
11	29504 206 2100
12	29524 106 5200

Dyn. Focus.

01	29305 025 2900
02	29305 025 3600
03	29305 025 3700
04	29305 025 3800
05	29305 025 4000
06	29305 025 4200
07	29305 025 4300
08	29305 025 4400
09	29305 025 4500
10	29305 025 4700
11	29305 025 4900
12	29305 025 4800
13	29305 025 5000
14	29305 025 2100
15	29305 025 5100

Signal Modules

01	29504 102 3400
02	29504 102 3500
03	29504 102 3600
04	29504 162 3400
05	29504 162 3500
06	29504 162 3600
07	29504 162 3700
08	29504 202 0100
09	29504 212 0200
10	29504 262 0100
11	29504 212 0300
12	29504 262 0200
13	29504 262 0300
14	29504 202 0100
15	29504 202 2100
16	29504 262 2100
17	29504 202 2200
18	29504 212 0400
19	29504 262 2300
20	29504 262 2400
21	29504 202 2400
22	29305 303 0100
23	29305 302 0100
24	29305 302 0300
25	29504 202 2500

Tuner

03	29504 201 2100
04	29504 201 3100
06	29504 301 0100
07	61406 016 1000
08	61406 016 1200
09	61406 016 1300
10	61406 016 1400
12	81406 016 1000
13	81406 016 1200
15	81406 016 1400
16	81406 016 1900
17	29504 301 0200
18	29504 301 0300
19	29504 301 0400
20	81406 016 1100
21	81406 016 1500
22	29504 501 0100
23	29504 501 0200
24	75955 059 4900
25	75955 045 1300

Different Modules

02	Double Window Module	29504 109 2100
03	BSO Board	29305 119 4400
04	Dolby Module	29305 119 1700
09	EURO AV3 Board	29305 160 3700
10	Feature Board	29305 129 0700
11	Feature Board CTI/LTI	29305 119 3500
12	Felocity Modulation Board	29305 108 0700
16	IRDT Module	29504 207 0100
17	LFR Board	29305 014 4100
19	Mains Interference Elimination Board	29308 150 0700
23	PALplus (Feature Box)	29305 014 4000
24	Panorama View	29305 129 0400
25	Rotation Board	29305 129 0200
26	UG2-Shift/Panorama View	29305 119 4300
28	YUV Interface Board	29305 129 0600
29	IF Sound (Nicam)	29504 162 3900
30	IF Sound (Stereo)	29504 102 4000
31	Sound/Filter Board	29305 129 0100
32	ASIS Unit	29504 108 2300
37	PALplus Board	29305 014 4700
38	LED Board	29305 017 6000
40	Motor Control Board	29305 150 2100
41	AC3-Out Board	29305 160 6400
42	Aux Board 12V	29305 160 6100
43	RS 232 Adapter Board	29305 160 6200
44	Adapter Board	29305 129 1200
45	Rotationsplatte	29305 129 1800
47	PALplus-Platte	29305 014 4800
48	Rotation Board	29305 129 1600
51	LED Board	29305 017 6400
52	Sound/Filter Board	29305 129 0100
54	COM Module	29504 108 2400
55	DVD Control Board	29305 129 1700
57	DVD Module	29638 395 1201
58	Speaker Deplexer Board	29304 018 0700
59	AF Inversion PCB	29305 119 7800
60	DVD Unit	29632 255 0100
61	Shift Board	29305 109 0100
62	DVD KIT1	
64	Feature/SVM Board	29305 129 2000
65	COM Module	29504 108 2700
66	Clock Module	29501 088 0200
67	Fan Control	29305 308 0100
68	Connection Board Signal	29305 307 0100
69	Chassis Digital	29305 305 0200
70	DVD Unit	29632 275 0100
71	Amplifier Subwoofer	29325 309 1100
72	Motor Control Rot. Stand	29305 308 0200
73	Motor Control Mask	29305 308 0300
74	IF Module	29504 102 5700
75	LED Board	29305 017 6600
76	Panorama View	29305 119 6800

SAT Modules

03	29504 106 2800
06	29504 106 2900

VGA Modules

01	29305 160 3500
02	29305 160 3600
03	auf Prozessorpl.
04	auf PIP-Baustein

TV

Mains Units

01	Mains Unit 12V	29305 007 3200
02	Mains Unit Standby	29304 050 2900
03	Mains Unit Standby	29304 050 8200
04	Mains Unit 12V	29305 007 3100
05	Mains Unit 12V	29305 007 3300
06	Mains Unit Standby	29304 050 8500
07	Mains Unit 5.0V/0.4A	29304 050 8400
08	Mains Unit 12V	29305 007 3400
09	Mains Unit Board	29305 202 2100
10	Mains Unit Standby	29305 306 0300
11	Mains Unit Box	29305 306 0100
12	Mains Unit AF	29305 306 0200
13	Mains Unit Display	29305 209 9000
14	Mains Unit ASIS	29304 050 8000

Retrofitable Modules

01	AF Module DPL 2	GAD 8900
03	PIP Module PIP 2	GAD 2300
04	PIP Module PIP 3	GAD 5400
05	PIP Module PIP 4	GAD 9000
06	PIP Module PIP 5	GAE 2000
07	PIP Module PIP 6	GAE 7300
08	SAT Module SER 150 ET	GAD 2500
09	SAT Module SER 2000	GAE 0600
10	SAT Module SER 250	GAE 0700
11	SAT Module SER 300	GAE 3700
12	SAT Module SNR 105	GAD 9551
14	VGA Module VGA 2	GAD 4200
15	VGA Module VGA 3	GAF 4900
16	ASIS Unit	29504 108 2300
17	ASIS Mains Unit	29304 050 8000
18	SAT Module SER 2001	GAF 8300
19	PIP Module PIP 3a	GAF 6500
20	GDV Module 1	GAF 1400
21	SNR DTR 2000 S	GAF 1251
22	SAT Module SER 251	GAF 9100
23	VGA Module VGA 4	GAF 9200
24	PIP Module PIP 7	GAF 9300
25	SAT Module SER 300A	GAF 9000
26	SAT Module SER 2100	GAG 3000
27	SAT Mod. DER 1101 S/T-CI	GAG 6900
28	SAT Mod. DER 1100 S/T-CI	GAG 6600
29	Wireless Set WT2	GAG 8900
30	SAT Module SER 252	GAG 8000
31	SAT Module SER 520	GAE 1700

Remote Controls

01	TP 712	29642 063 0100
02	TP 715	29642 062 1102
04	TP 715	29642 062 4700
06	TP 750 C	29642 062 1800
07	TP 750 C	29642 062 1900
08	TP 750 C	29642 062 5100
09	TP 750 C	29642 062 5200
10	TP 750 C	29642 062 5300
11	TP 800	29642 061 0104
12	TP 810 C	29642 061 1001
13	TP 815 C	29642 061 1400
14	TP 850 C	29642 061 0901
15	TP 900	29642 061 1103
16	TP 910 C	29642 061 1201
17	TP 711	29642 062 0100
18	TP 713	29642 063 0400
23	TP 800 Hotel	29642 061 0800
24	TP 715 Hotel	29642 062 1600
25	Personal Remote 10	29642 061 1501
26	TP 912 C	29642 061 3300
27	TP 100 C	29642 061 4102
28	TP 100 C	29642 061 4600
29	TP 110 C	29642 061 4200
30	TP 110 C	29642 061 4202
31	TP 800 H	29642 061 1900
32	TP 120 DC	29642 061 0600
33	TP 150 C	29642 066 0300
34	TP 150 C	29642 066 0400
35	TP 140 C	29642 061 4800
36	TP 800 Hcl	29642 061 5600
37	TP 800 H (Roombase)	29642 061 5700
38	TP 950 C	29642 061 0701
39	TP 741 C	75955 059 0700
40	TP 751 C	29642 062 5400

Footnotes

*	optional
**	dependent on CRT panel
***	dependent on CRT
•	dependent on signal module
••	dependent on processor panel
•••	dependent on chassis
◦	optional when software index \geq 19798 318 1000
◦◦	optional when software index \geq 19798 323 0100
#	dependent on feature box

Sets Chart (Coding of the Modules on pages 2.14/2.15/2.16)

Set	CUC																						
	2103	2103	2103		2103	2103		2103	2103			1930	2059D	2059D	2059D	1930	1930	1934	1934	2059D	2059D		
ARCANCE 37 P37-2101 MV (VNA)																							
ARCANCE 37 P37-2101 MV (VNM)																							
ARCANCE 37 P37-2101 TR (VNM)																							
ARCANCE 37 P37-5211																							
ARCANCE 51 T51-2101 MV (VNA)																							
ARCANCE 51 T51-2101 MV (VNM)																							
ARCANCE 55 FLAT TF55-5211																							
ARCANCE 55 T55-2101 MV (VNA)																							
ARCANCE 55 T55-2101 MV (VNM)																							
ARCANCE 55 T55-5211																							
ARCANCE 72 FLAT TF72-5211																							
ARGANTO 70 FLAT MFW70-530/9 DPL (VNM)																							
ARGANTO 70 MW70-500 IRDT (VNM)																							
ARGANTO 70 MW70-502 IRDT/DOLBY (VNM)																							
ARGANTO 70 MW70-505 IRDT/DPL (VNM)																							
ARGANTO 70 MW70-510/8 A DPL (VNM)																							
ARGANTO 70 MW70-510/8 DPL (VNM)																							
ARGANTO 70 MW70-515 MV/DOLBY (VNA)																							
ARGANTO 70 MW70-515 MV/DOLBY (VNM)																							
ARGANTO 70 MW70-600 IRDT (VNM)																							
ARGANTO 70 MW70-605 IRDT/DPL (VNM)																							
Control Unit																							
CRT Panel	55	55	55		52	52		52	52			42	43	43	43	44	44	53	53	43	43		
Socket Board												13				13	13					14	
EPG-Platte												01				01							
Dyn. Focus, Feature Box												03											
Keyboard												12	12	12		13	11	19	19				
Mains Switch Board												10	12	12	12	10	10	16	16	12	12		
Mains Unit												14	09	09	09	14	07	24	24	09	09		
AF Module												03				03	03						
East/West PIP Module												31	22	22	23	31	25	33	33	22	23		
Processor Board	23	23	22		23	23		23	23			11/18*	06	26	06	11/18*	09			06	06		
SAT Module																							
Signal Module												10				10	10	20	16				
Tuner	06	06	06	24	06	06	24	06	06	24	24	06	06	06	06	06	06	23	17	06	06		
VGA Module																							
Different Modules													16	24	16		09			24	24		
Different Modules												25	24	28	24					28	28		
Different Modules												28	28	16	28					16	16		
Different Modules												09				09							
Different Modules																							
Different Modules																							
Different Modules																							
Different Modules																							
Different Modules																							
Different Modules																							
Remote Control	06	06	06	39	06	06	39	06	06	39	39	14	13	13	13	14	14	28	28	13	13		
Remote Control retrofittable		26			26			26				06				06	06	23	23				
Remote Control retrofittable												07				07	07	24	24				
Remote Control retrofittable												11				11	11	25	25				
Remote Control retrofittable																							
Remote Control retrofittable																							
MI	02	01	02	02	01	01	02	02	01	02	02	00	99	01	99	00	99	02	01	00	00		

*/**/****/●/●●/●●●/°/°°/# see page 2.16



Set	CUC																	
	1931	1931	2058D	2058D	2058D	1931	1931	1935	1935	1983	2058D	2058D	1838	1838	1838	1830	1832	
Control Unit																		
CRT Panel	48	48	43	43	43	48	42	51	51	34	43	43	32	32	32	36	17	
Socket Board	13	19/13			14	13	13			12		14	58	58	58/61***	07	44	
EPG-Platte	01					01	01					25	25	25			01	
Dyn. Focus,	03	03				03	03	08	08	01			07	07	07/11			
Feature Box	15	15				16	10	22	22	05/09*			23	23	23	08	13	
Keyboard	10	10	12	12	12	10	10	16	16	11	12	12						
Mains Switch Board	14	21	09	09	09	14	07	22	22	08	09	09	20	20	32		10	
Mains Unit	03	06				03	03										03	
AF Module	31	32	22	22	23	31	25	33	33	19	22	23					24	
East/West PIP Module										07/08						04	09	
Processor Board	11/18*	28	06	26	06	11/18*	08				06	06					10	
SAT Module																		
Signal Module	13	13				13	10	20	16	05*/07*			17	25	17	01	08/11	
Tuner	06	06	06	06	06	06	06	23	17	03/06	06	06	17	23	17	03	06/17	
VGA Module							03			01								
Different Modules		45	16	24	16					04	24	24						
Different Modules	45		24	28	24					02	28	28						
Different Modules		44	28	16	28					23	16	16						
Different Modules	44	55				44												
Different Modules	09	57				09	25											
Different Modules																		
Different Modules																		
Different Modules																		
Different Modules																		
Different Modules																		
Different Modules																		
Remote Control	14	32	13	13	13	14	14	28	28	14	13	13	26	26	26	15	16	
Remote Control retrofitable	06	06*				06	06	23	23	08			23	23	23		07	
retrofitable	07	07*				07	07	24	24				24	24	24		15	
retrofitable	11	11*				11	11	25	25				25	25	25		11	
retrofitable		25*																
retrofitable																		
MI	00	01	99	01	99	00	99	02	01	99	00	00	01	02	02	98	00	

*/**/**/•/••/•••/°/°°/# see page 2.16

Set	CUC				1806	1806	2021	2121	2121	2121M	2121M	2121M	2121M	2021N	2021F	2021F	2021N	2103GB
	DAVIO 51 T51-4201 TOP	DAVIO 51 T51-4201 TOP	DAVIO 51 T51-4201/5 TOP	DAVIO 51 T51-4201/5 TOP														
Control Unit					14	14												
CRT Panel					36	36	08	52	52	52	52	52	52	38	38	38	08	52
Socket Board														15	15			
EPG-Platte																		
Dyn. Focus, Feature Box					13/16	08												
Keyboard																		
Mains Switch Board																		
Mains Unit					02	02												
AF Module							29	29	29	30	30	30	30	02	02	30	30	
East/West PIP Module																		
Processor Board								35	24	25/30	25/30*	25	36					22
SAT Module																		
Signal Module					04/06°	04/06°												
Tuner	25	25	25	25	03•/06•	03•/06•	06	22	06	06	06	06	22	06	06	06	06	19
VGA Module					02	02												
Different Modules																		
Different Modules																		
Different Modules																		
Different Modules																		
Different Modules																		
Different Modules																		
Different Modules																		
Different Modules																		
Different Modules																		
Different Modules																		
Remote Control	40	40	40	40			02*	06	07	07	07	07	07	02*	02*	02*	02*	06
Remote Control							07*							07*	07*	07*	07*	
retrofitable					04	04	18	26	26			26	09	09	18	18		
retrofitable					08	08												
retrofitable																		
retrofitable																		
retrofitable																		
MI	02	02	02	02	99	99	00	02	01	01	02	01	02	99	00	00	00	02

*/**/****/•/••/•••/°/°°/# see page 2.16



Set	CUC												
	2130M	1837	1837	2030N	2050N	2050N	2035F	2035F	1935	1935	1935	1984	
DAVIO 70 ST70-5101/8 DOLBY (VNIM)													
DAVIO 70 ST70-5210/8 DOLBY (VNA)		DIGI100											
DAVIO 70 ST70-5210/8 DOLBY (VNIM)		DIGI100											
DAVIO 70 ST70-8510 NIC/DOLBY (VNIM)													
DAVIO 70 ST70-853 NIC/PIP (VNIM)													
DAVIO 70 ST70-854 PIP/Dolby (VNIM)													
DAVIO 70 ST70-870 FR/TOP (VNIM)													
DAVIO 70 ST70-880 FR/Dolby (VNIM)													
DENVER FLAT SE8260/8 DOLBY (VNG)		DIGI 100											
DENVER FLAT SE8260/8 DOLBY (VNM,VNA)		DIGI 100											
DENVER FLAT SE8260/8 DOLBY (VNX)		DIGI 100											
DENVER SE82-100 PAL PLUS (mit dw)		Digi 6											
Control Unit	50			16	16	16	16	16					
CRT Panel	59	49	49	41	41	41	41	41	50	50	50	29/34**	
Socket Board	27								25	25	25		
EPG-Platte													
Dyn. Focus,									13	09	09		
Feature Box		19	19						24	24	24	05	
Keyboard									16	16	16		
Mains Switch Board									23/24	23/24	23/24		
Mains Unit													
AF Module	30								33	33	33	20	
East/West	08/10/13***												
PIP Module					01								
Processor Board	32			18			03						
SAT Module													
Signal Module		20	16						20	16	20	05	
Tuner	29/13*	23	17	06	06*/13*	06*/13*	06*/13*	06	23	17	23	03	
VGA Module												01	
Different Modules					11	11						02	
Different Modules													
Different Modules													
Different Modules													
Different Modules													
Different Modules													
Different Modules													
Different Modules													
Different Modules													
Different Modules													
Different Modules													
Remote Control	33	27	27	07	11	12	02	02*	26	26	26	15	
Remote Control								07*					
retrofitable		23	23	12			12		23	23	23		
retrofitable		24	24		01	01			24	24	24		
retrofitable		25	25		10	10			25	25	25		
retrofitable													
retrofitable													
MI	02	02	02	00	00	00	99	00	02	01	02	98	

*/**/****/●/●●/●●●/°/°°/# see page 2.16

Set	CUC																			
	2030N	2131M	2131M	1838	1838	1838	1838	1838	1838	1838	1838	2068N	1935	1935	1935	1935A	1935	1935	1935	
ELEGANCE 70 ST70-904 NIC/DOLBY (VNM)	ELEGANCE 70 ST70-904 NIC/DOLBY (VNM)																			
ELEGANCE 72 FLAT MF72-3101/8 DOLBY (VNA)	ELEGANCE 72 FLAT MF72-3101/8 DOLBY (VNA)																			
ELEGANCE 72 FLAT MF72-3101/8 DOLBY (VNM)	ELEGANCE 72 FLAT MF72-3101/8 DOLBY (VNM)																			
ELEGANCE 72 FLAT MF72-3110 DOLBY (VNA)	ELEGANCE 72 FLAT MF72-3110 DOLBY (VNA)																			
ELEGANCE 72 FLAT MF72-3110 DOLBY (VNM)	ELEGANCE 72 FLAT MF72-3110 DOLBY (VNM)																			
ELEGANCE 72 FLAT MF72-3110 DOLBY (VNX)	ELEGANCE 72 FLAT MF72-3110 DOLBY (VNX)																			
ELEGANCE 72 FLAT MF72-3110/8 DOLBY (VNA)	ELEGANCE 72 FLAT MF72-3110/8 DOLBY (VNA)																			
ELEGANCE 72 FLAT MF72-3110/8 DOLBY (VNM)	ELEGANCE 72 FLAT MF72-3110/8 DOLBY (VNM)																			
ELEGANCE 72 FLAT MF72-3110/8 DOLBY (VNX)	ELEGANCE 72 FLAT MF72-3110/8 DOLBY (VNX)																			
ELEGANCE 72 FLAT MF72-3115/8 DOLBY (VNA)	ELEGANCE 72 FLAT MF72-3115/8 DOLBY (VNA)																			
ELEGANCE 72 FLAT MF72-3115/8 DOLBY (VNM)	ELEGANCE 72 FLAT MF72-3115/8 DOLBY (VNM)																			
ELEGANCE 82 FLAT MFW82-3101 NIC/DOLBY (VNM)	ELEGANCE 82 FLAT MFW82-3101 NIC/DOLBY (VNM)																			
ELEGANCE 82 FLAT MFW82-3110 MV/DOLBY (VNA)	ELEGANCE 82 FLAT MFW82-3110 MV/DOLBY (VNA)																			
ELEGANCE 82 FLAT MFW82-3110 MV/DOLBY (VNG)	ELEGANCE 82 FLAT MFW82-3110 MV/DOLBY (VNG)																			
ELEGANCE 82 FLAT MFW82-3110 MV/DOLBY (VNM)	ELEGANCE 82 FLAT MFW82-3110 MV/DOLBY (VNM)																			
ELEGANCE 82 FLAT MFW82-3110 MV/DOLBY (VNR,V)	ELEGANCE 82 FLAT MFW82-3110 MV/DOLBY (VNR,V)																			
ELEGANCE 82 FLAT MFW82-3110 MV/DOLBY (VNX)	ELEGANCE 82 FLAT MFW82-3110 MV/DOLBY (VNX)																			
ELEGANCE 82 MW82-150/8 DOLBY (VNA)	ELEGANCE 82 MW82-150/8 DOLBY (VNA)																			
ELEGANCE 82 MW82-150/8 DOLBY (VNM)	ELEGANCE 82 MW82-150/8 DOLBY (VNM)																			
Control Unit	26	52	52									46								
CRT Panel	41	59	59	60	60	58	60	60	58	60	60	43	50	58	50	58/50***	50	51	51	
Socket Board		27	27																	
EPG-Platte																				
Dyn. Focus, Feature Box				18	18	07	18	18	07	18	29	29	09	15	09	13/15***	13	08	08	
Keyboard																				
Mains Switch Board																				
Mains Unit																				
AF Module		30	30																	
East/West		16	16																	
PIP Module																				
Processor Board		36	32																	
SAT Module																				
Signal Module				21	15	21	20	16	20	20	16		20	20	16	20	20	20	16	
Tuner	06	22	06/13*	23	17	23	23	17	23	23	17	22	23	23	17	23	23	23	17	
VGA Module																				
Different Modules												24								
Different Modules																				
Different Modules																				
Different Modules																				
Different Modules																				
Different Modules																				
Different Modules																				
Different Modules																				
Different Modules																				
Different Modules																				
Different Modules																				
Different Modules																				
Remote Control	06	33	33	30	30	30	30	30	30	30	30	33	29	29	29	34	29	27*	27*	
Remote Control																		28*	28*	
retrofitable				23	23	23	23	23	23	23	23		23	23	23	23	23	23	23	23
retrofitable				24	24	24	24	24	24	24	24		24	24	24	24	24	24	24	24
retrofitable				25	25	25	25	25	25	25	25		25	25	25	25	25	25	25	25
retrofitable				27	27	27	27	27	27	27	28	28				28				
retrofitable				28	28	28	28	28	28	28						27				
MI	01	02	02	02	01	02	02	01	02	02	02		02	02	01	02	02	02	01	

*/**/****/●/●●/●●●/°/°°/# see page 2.16



Set	ELEGANCE 82 MW82-2101 DOLBY (VNM)			FINE ARTS PLANAVISION PW110-8110/9 DOLBY (VNM)	FINE ARTS VISION MFW82-710/8 DVD (VNM)	FINE ARTS VISION MFW82-710/9 DPL/PIP (VNM)	FINE ARTS VISION MFW82-710/9 DVD (VNA)	FINE ARTS VISION MFW82-710/9 DVD (VNX)	FINE ARTS VISION MFW82-720/9 DVD (VNM)	GREENVILLE 100 SE7030 (VNM)	GREENVILLE 370 SE3781 text
	2058	2058N	2068N								
Control Unit	26	26	46		25	25	25	25	25		
CRT Panel	43	45	45		46	46	46	46	46	36	09
Socket Board				35/34	13/17/19	17/13	17/19/13	17/19/13	17/13	07	
EPG-Platte					03••	03	03•	03•	03		
Dyn. Focus,					05	05	05	05	05		
Feature Box				30	14/17*	14	14/17*	14/17*	14	08	
Keyboard										03	
Mains Switch Board				29						02	
Mains Unit				10/11/12/13	06	03	06	06	03	02/03	
AF Module				37	31	25	31	31	25		
East/West											
PIP Module					09	09	09	09	09	03	
Processor Board		19	34		17/21*	16*/17*	17/21*	17/21*	16*/17*		
SAT Module											
Signal Module				22/23/24	12/09	12/09	12/09	12/09	12/09	04/06°	
Tuner	06	06	22		06/16	16/18	18	18	16/18	03•/06•	06*/08*
VGA Module						03	03	03	03		
Different Modules	11	10	64	71	37•/47•	37	37#	37#	37		
Different Modules	24	24	24	72			47#	47#			
Different Modules				73	38	38	48	48	38		
Different Modules				67	48						
Different Modules				68	40	25	38	38	25		
Different Modules				69	41	40	42	42	40		
Different Modules				70	42	09	43	43	09		
Different Modules						41/42	40	40	41/43		
Different Modules											
Different Modules											
Different Modules											
Remote Control	12	12	33	25	25	25	25	25	25	15	02
Remote Control											
retrofitable	05	05	30	31	07	07	07	07	07	04	
retrofitable					11	11	11*	11*	11	08	
retrofitable	22	22				20	25*	25*	21	14	
retrofitable											
retrofitable											
MI	01	01		02	01	00	01	01	00	99	98

*/**/***./•/••/•••/°/°°/# see page 2.16

Set	CUC																				
	2136M	2121	2121M	1807	2121	2121	2121M	2121M	2121M	2103H	2103H	2103H	2103	2103	2131M	2131M	1838	1838	1838	1838	
LEEMAXX 55 FLAT MF55-9101/8 DOLBY (VNM)																					
LEEMAXX 55 FLAT MF55-9201 DOLBY (VNM)																					
LEEMAXX 55 FLAT MF55-9201/8 DOLBY (VNM)																					
LEEMAXX 55 M55-4210 DOLBY (VNM)				DIGI 100																	
LEEMAXX 55 ST55-4105 DOLBY (VNA)																					
LEEMAXX 55 ST55-4105 DOLBY (VNM)																					
LEEMAXX 55 ST55-4105 MV/DOLBY (VNA)																					
LEEMAXX 55 ST55-4105 MV/DOLBY (VNM)																					
LEEMAXX 55 ST55-4105 MV/DOLBY (VNX)																					
LEEMAXX 55 T55-4104 M/COM/CL (VNA)																					
LEEMAXX 55 T55-4104 M/HOT/CL (VNA)																					
LEEMAXX 55 T55-4104 M/HOT/CL (VNM)																					
LEEMAXX 55 T55-4104 TOP (VNA)																					
LEEMAXX 55 T55-4104 TOP (VNM)																					
LEEMAXX 72 FLAT MF72-9101/8 DOLBY (VNA)																					
LEEMAXX 72 FLAT MF72-9101/8 DOLBY (VNM)																					
LEEMAXX 72 FLAT MF72-9110/8 DOLBY (VNA)				DIGI 100																	
LEEMAXX 72 FLAT MF72-9110/8 DOLBY (VNM)																					
LEEMAXX 72 FLAT MF72-9110/8 DOLBY (VNX)																					
LEEMAXX 72 FLAT MF72-9115/8 DOLBY (VNA)				DIGI100																	
Control Unit	40																				
CRT Panel	59	64	64	49	52	52	52	52	52	52	52	52	52	52	53	53	60	60	58	60	
Socket Board	27		27												27	27					
EPG-Platte																					
Dyn. Focus, Feature Box				19													18	18	07	29	
Keyboard																					
Mains Switch Board																					
Mains Unit																					
AF Module	30	35	36		29	29	30	30	30	07					30	30					
East/West	14...														16	16					
PIP Module																					
Processor Board	32	37	38		35	24	24/25	24/25	36	39	39	39	29	29	36	32					
SAT Module																					
Signal Module				21													20	16	20	20	
Tuner	06	22	22	23	22	06	06	06	06	22	22	22	06	06	06	22	06/13*	23	17	23	23
VGA Module																					
Different Modules										65	66	66									
Different Modules										66											
Different Modules																					
Different Modules																					
Different Modules																					
Different Modules																					
Different Modules																					
Different Modules																					
Different Modules																					
Different Modules																					
Different Modules																					
Different Modules																					
Remote Control	34	34	34	34	06	07	07	07	06	37	36	36	07	07	34	34	30	30	30	30	
Remote Control retrofittable	26	26		23	26	26			26						26						
retrofittable				24													23	23	23	23	
retrofittable				25													24	24	24	24	
retrofittable				27													25	25	25	25	
retrofittable				28													27	27	27	28	
retrofittable																	28	28	28		
MI	01	02	02	02	02	01	02	01	02	02	02	02	02	01	02	02	02	01	02	02	

*/**/****/●/●●/●●●/°/°°/# see page 2.16





Set	CUC												
	MW70-2203 FR/DOLBY (VNM)	MW70-2203 NIC/DOLBY (VNM)	MW70-269 PAL PLUS (mit dw)	MW70-2690 NIC/TOP	MW70-2699 DPL/FT (VNM)	MW70-2699 FR/TOP (VNM)	MW70-2699 NIC/FT (VNM)	MW70-2699 NIC/TOP (VNA)	MW70-2699 NIC/TOP (VNM)	MW70-2700 Dolby (VNM)	MW70-2700 FR/Dolby (VNM)	MW70-2700 NIC/DOLBY (VNA)	MW70-2701 DOLBY/FT (VNM)
	2069F	2069N	Digi 6 1952	2059N	2059N	2059F	2059N	2059N	2059N	2059	2059F	2059N	2059N
Control Unit													
CRT Panel	43	43	33	40	43	43	43	45	43	43	45	43	43
Socket Board	36	36			04	04	04	04	04	04	04	04	04
EPG-Platte													
Dyn. Focus, Feature Box			05										
Keyboard	17	17			07	07	06	06	07	07	07	07	06
Mains Switch Board	33	33			04	04	04	04	04	04	04	04	04
Mains Unit													
AF Module			20										
East/West PIP Module													
Processor Board					01*/04*	05			01*/04*				
SAT Module													
Signal Module			02										
Tuner	22	22	03	06*/08*	06*/13*	06*/13*	06*/13*	06*/13*	06*/13*	06*/13*	06*/13*	06	06
VGA Module													
Different Modules	24	76	02		11	11	11	10	11	11	24	11	11
Different Modules		24			24	24	24	24	24	24	10	24	
Different Modules													
Different Modules													
Different Modules													
Different Modules													
Different Modules													
Different Modules													
Different Modules													
Different Modules													
Different Modules													
Remote Control	33	33	11	11	11	11	12	12	11	12	12	12	12
Remote Control retrofittable					01	01	05	05	01	05	10	05	01
retrofittable					05	05	01	01	05	01	15	05	05
retrofittable					12	12	10	10	12	10	01	22	22
retrofittable													
retrofittable													
MI	02	02	98	98	99	99	00	00	99	00	00	01	00

*/**/****/●/●●/●●●/°/°°/# see page 2.16



Set	CUC												
	MW82-2699 NIC/TOP (VNM)	MW82-2700 Dolby (VNM)	MW82-2700 FR/Dolby (VNM)	MW82-2700 NIC/DOLBY (VNM)	MW82-2701 DOLBY/FT (VNM)	MW82-3112 MV/DOLBY (VNA)	MW82-3112 MV/DOLBY (VNM)	MW82-3699 DOLBY/FT (VNM)	MW82-3699 NIC/FT (VNM)	MW82-3700 DPL/FT (VNM)	MW82-40/8 (VNM)	MW82-45/8 (VNM)	MW82-50/8
	2058N	2058	2058F	2058N	2058N	DIGI 100 1935	DIGI 100 1935	2058N	2058N	2058N	1836 Basic++	1929 BASIC++	1929 Basic++
Control Unit											20		
CRT Panel	43	43	45	43	43	51	51	45	43	43	39	39	39
Socket Board	04	04	04	04	04	24	24	04	04	16/04		06	06
EPG-Platte													
Dyn. Focus, Feature Box						08	08				02	02	
Keyboard	07	07	07	07	07	15	15	06	06	06	08	08	08
Mains Switch Board	04	04	04	04	04	19	19	04	04	04	04	05	
Mains Unit											02*/03*	02/03	
AF Module										18			
East/West PIP Module													
Processor Board	01*/04*												
SAT Module													
Signal Module						20	16				04/06°	06*/04*	04
Tuner	06*/13*	06*/13*	06*/13*	06	06	23	17	06*/13*	06*/13*	06*/13*	04/03/06•	03•/06•	03
VGA Module													
Different Modules	11	11	24	11	11			10	11	11	12		
Different Modules	24	24	10	24	24				24	24		12	
Different Modules													
Different Modules													
Different Modules													
Different Modules													
Different Modules													
Different Modules													
Different Modules													
Different Modules													
Different Modules													
Different Modules													
Remote Control	11	12	12	12	12	28	28	12	12	12	12	12	11
Remote Control retrofitable	01	05	10	05	01	23	23	01	01	05	04	14	
retrofitable	05	01	15		05	24	24	05	05	10	08	19	
retrofitable	12	10	01	22	22	25	25	22	10		14	08	
retrofitable													
retrofitable													
MI	99	00	00	01	00	02	01	00	00	00	99	01	98

*/**/****/•/••/•••/°/°°/# see page 2.16

Set	CUC														
	7303	7303	2003H	7303	7303	7303	7303	7303	7303	7303	7305	7305	7303	7303	7303
Control Unit	20	20	09	20	20	20	20	20	20	20	20	20	20	20	20
CRT Panel															
Socket Board															
EPG-Platte															
Dyn. Focus,															
Feature Box															
Keyboard															
Mains Switch Board															
Mains Unit												04			
AF Module															
East/West															
PIP Module															
Processor Board			15												
SAT Module															
Signal Module															
Tuner	06	06	06*/13*	07*/10*	06	19	06	06	12*/15*	07*/10*	06	07*/10*	06	06	06
VGA Module															
Different Modules			31												
Different Modules															
Different Modules															
Different Modules															
Different Modules															
Different Modules															
Different Modules															
Different Modules															
Different Modules															
Remote Control	07	02*	24	02	02*/07	07	07	06	02	02	07	02	02*	02*	02*
Remote Control	02*	07*			08/09/10	02*							07*	07	07
retrofitable			16												
retrofitable			17												
retrofitable															
retrofitable															
retrofitable															
MI	00	00	99	98	00	00	00	00	99	98	00	98	00	00	00

* / ** / *** / ● / ●● / ●●● / ° / °° / # see page 2.16



Set	CUC													
	7303	7303	7303	2005	7303	7303F	7303F	7303F	7303F	7303F	7303	7303	7303F	7303F
Control Unit														
CRT Panel	20	20	20	09	20	20	04	20	20	20	20	20	20	20
Socket Board														
EPG-Platte														
Dyn. Focus, Feature Box														
Keyboard														
Mains Switch Board														
Mains Unit				01										
AF Module														
East/West														
PIP Module														
Processor Board				07										
SAT Module				03										
Signal Module														
Tuner	12*/15*	06	12*/15*	06*/13*	07*/10*	06	07*/10*	07*/10*	06	19	06	06	06	06
VGA Module														
Different Modules														
Different Modules														
Different Modules														
Different Modules														
Different Modules														
Different Modules														
Different Modules														
Different Modules														
Different Modules														
Different Modules														
Different Modules														
Remote Control	02	02*	02	02	02	02	17	02	02	07	02*	02*	02*	02*
Remote Control		07								02*	07*	10*	08*	09*
retrofitable														03
retrofitable														
retrofitable														
retrofitable														
retrofitable														
MI	99	00	99	99	98	00	98	98	99	00	00	00	00	00

*/**/****/●/●●/●●●/°/°°/# see page 2.16



	Set						CUC												
	1837	1837	1837	1837	1837	1837	2130	1838	1838	1838	1838	1838	1838	1838	2131	2131	2131M		
	SEDANCE 70 ST70-284/8 DOLBY (VNM)						SEDANCE 70 ST70-5101 DOLBY (VNA)												
	SEDANCE 70 ST70-284/8 DOLBY (VNR)						SEDANCE 72 M72-2110 DOLBY (VNG)												
	SEDANCE 70 ST70-284/8 DOLBY (VNU)						SEDANCE 72 M72-2110 DOLBY (VNM, VNA)												
	SEDANCE 70 ST70-284/8 DOLBY (VNX)						SEDANCE 72 M72-2110 DOLBY (VNX)												
	SEDANCE 70 ST70-285/8 DOLBY (VNM, VNA)						SEDANCE 72 M72-2110 MV/DOLBY (VNA)												
	SEDANCE 70 ST70-285/8 DOLBY (VNX, VNG)						SEDANCE 72 M72-2110 MV/DOLBY (VNG)												
Control Unit							37												
CRT Panel	49	49	49	49	49	49	59	49	49	49	49	49	53	49	63	63	63		
Socket Board								21	21	21	23	23	23	23	30	30	31/27		
EPG-Platte																			
Dyn. Focus, Feature Box	19	19	19	19	28	28		19	19	19	19	19	19	19					
Keyboard								13	13	13	15	15	15	15	17	17	17		
Mains Switch Board								17	17	17	19	19	19	19	28	28	28		
Mains Unit																			
AF Module							29							29	29	30			
East/West PIP Module							08/10/12/13***							15	15	15			
Processor Board							35							35	31	36			
SAT Module																			
Signal Module	16	20	20	16	16	20		21	15	15	16	20	16	16					
Tuner	17	23	23	17	17	23	22	23	17	17	17	23	17	17	22	06/13*	22		
VGA Module																			
Different Modules																			
Different Modules																			
Different Modules																			
Different Modules																			
Different Modules																			
Different Modules																			
Different Modules																			
Different Modules																			
Different Modules																			
Different Modules																			
Different Modules																			
Remote Control	28	33	33	33	28	28	33	33	28	33	28	33	28	33	33	33	33		
Remote Control retrofittable	23	23	23	23	33*	33*	26	23	23	23	23	23	23	23	26	26			
Remote Control retrofittable	24	24	24	24	24	24		24	24	24	24	24	24	24					
Remote Control retrofittable	25	25	25	25	25	25		25	25	25	25	25	25	25					
Remote Control retrofittable																			
Remote Control retrofittable																			
MI	01	02	02	02	02	02	02	02	01	02	02	02	01	02	02	02	02		

*/**/****/●/●●/●●●/°/°°/# see page 2.16

Set	CUC														
	2020	2021	2021	2021	2020F	2021F	2021F	2121	2121	2121	2121M	2121M	2121M	2121F	2121GB
ST55-850 TOP															
ST55-855 TOP (VNM)															
ST55-898 DOLBY (VNM)															
ST55-898 TOP (VNM)															
ST55-900 FR/TOP															
ST55-905 FR/TOP (VNM)															
ST55-906 FR/DOLBY (VNM)															
ST55-908 DOLBY (VNA)															
ST55-908 DOLBY (VNM)															
ST55-908 DOLBY (VNX)															
ST55-908/8 DOLBY (VNA)															
ST55-908/8 DOLBY (VNM)															
ST55-908/8 DOLBY (VNX)															
ST55-908/8 FR/DOLBY (VNM)															
ST55-934 GB/DOLBY (VNA)															
Control Unit															
CRT Panel	08	08	08	08	08	38	38	52	52	64	52	52	52	52	52
Socket Board						15	15							27	
EPG-Platte															
Dyn. Focus,															
Feature Box															
Keyboard															
Mains Switch Board															
Mains Unit															
AF Module	06	01	29	01	07	02	30	29	29	35	30	30	30	30	30
East/West															
PIP Module															
Processor Board		02						35	24	37	25	25	36	25*/30*	24/27*
SAT Module															
Signal Module															
Tuner	08*/09*	06*/13*	06	06*/13*	08*/09*	06	06	22	06	22	06	06	22	06	06
VGA Module															
Different Modules															
Different Modules															
Different Modules															
Different Modules															
Different Modules															
Different Modules															
Different Modules															
Different Modules															
Different Modules															
Different Modules															
Different Modules															
Different Modules															
Remote Control	02	02	07	02	02	02*	06*	06	06	06	07*	07*	06	06	06
Remote Control						07*	07*				06*	06*			
retrofitable		09	18	09		09	18	26	26	26	26	26			26
retrofitable															
retrofitable															
retrofitable															
retrofitable															
MI	98	99	00	99	98	00	01	02	01	02	02	01	02	01	02

*/**/***/*/●/●●/●●●/°/°°/# see page 2.16

Set	CUC												
	2121GB	2121GB	2121GB	2121	2121	1836	1836	2030N	2030N	2030N	2032	2130M	2130M
Control Unit							24						
CRT Panel	52	52	52	52	52	36	36	09	09	09	09	39	39
Socket Board								41	41	41	41	59	59
EPG-Platte												27	27
Dyn. Focus, Feature Box						08	13/16						
Keyboard													
Mains Switch Board													
Mains Unit							06						
AF Module	30	30	30	29	29							30	30
East/West												09/11...	09/11...
PIP Module													
Processor Board	36	27	30	35	24			02*	03*	03*	02*	36	32
SAT Module													
Signal Module						04	06*/04*						
Tuner	22	19	16	22	06	03	03*/06*	06*/13*	06*/13*	06*/13*	06*/13*	22	06
VGA Module													
Different Modules													
Different Modules													
Different Modules													
Different Modules													
Different Modules													
Different Modules													
Different Modules													
Different Modules													
Different Modules													
Different Modules													
Different Modules													
Different Modules													
Remote Control	06	06	06	07	07	11	11	02	02	02	02	33	33
Remote Control													
retrofitable				26	26		14	12	12	12	10		
retrofitable							19						
retrofitable							08						
retrofitable													
retrofitable													
MI	02	01	02	02	01	98	01	99	99	99	99	02	01

*/**/****/●/●●/●●●/°/°°/# see page 2.16

Set	ST70-282/8 (VNM)		ST70-282/8 (VNX)		ST70-298 IDTV (VNM)		ST70-298 IDTV (VNX)		ST70-398 DOLBY (VNA)		ST70-398 DOLBY (VNM)		ST70-398 DOLBY (VNX)		ST70-5109/8 DOLBY (VNA)		ST70-5109/8 DOLBY (VNG)		ST70-5109/8 DOLBY (VNM)	
	Basic++	BASIC++	Basic++	Basic++	DIGI 100	DIGI 100	DIGI 100													
CUC	1836	1836	1836	1836	1837	1837	1837	2130M	2130M	2130M	2130M	2130M	2130M	2130M	2130M	2130M	2130M	2130M	2130M	2130M
Control Unit	23	23	24	24				50	50	50										
CRT Panel	06	36	36	36	49	49	49	59	59	59										
Socket Board								27	27	27										
EPG-Platte																				
Dyn. Focus, Feature Box	08	13/16	08	13/16	19	19	19													
Keyboard																				
Mains Switch Board																				
Mains Unit	02*/03*	06	02*/03*	02*/03*																
AF Module								30	30	30										
East/West								08/10***	08/10***	08/10***										
PIP Module																				
Processor Board								32	36	32										
SAT Module																				
Signal Module	04*/06*	06	01*/03*	01*/03*	15	15	21													
Tuner	03*/04*/06•	06	03*/04*/06•	03*/04*/06•	17	17	23	22	22	06/13*										
VGA Module																				
Different Modules																				
Different Modules																				
Different Modules	19																			
Different Modules																				
Different Modules																				
Different Modules																				
Different Modules																				
Different Modules																				
Different Modules																				
Different Modules																				
Different Modules																				
Remote Control	12	12	12	12	33	28	33	33	33	33										
Remote Control retrofitable	14	14	14	14	23	23	23													
retrofitable	19	19	19	19	24	24	24													
retrofitable	08	08	08	08	25	25	25													
retrofitable																				
retrofitable																				
MI	00	01	00	01	02	01	02	02	02	02										

*/**/***/*/•/••/•••/°/°°/# see page 2.16

Set												
	ST70-810 DPL	ST70-819 NIC/TOP	ST70-820 TOP (VNM)	ST70-822 DOLBY (VNM)	ST70-822/4 Dplby (VNM)	ST70-829 NIC/Dolby (VNM)	ST70-839 NIC/DOLBY (VNM)	ST70-850 NIC/PIP	ST70-860 FR/TOP	ST70-869 A IDTV (VNM)	ST70-869 A IDTV (VNX)	ST70-869 IDTV
CUC												
	2050N	2050N	2032	2032	2030N	2050N	2050N	2050N	2030F	1836	1836	1836
Control Unit			11	21	21	11	26			13	13	13
CRT Panel	35	35	41	41	41	41	41	35	35	36	36	36
Socket Board												
EPG-Platte												
Dyn. Focus, Feature Box										08	13/16	08
Keyboard												
Mains Switch Board												
Mains Unit										02*/03*	02*/03*	02
AF Module	18											
East/West PIP Module								01				
Processor Board			02*									
SAT Module												
Signal Module										04/06°	04/06°	04/06°
Tuner	06*/08*	06*/08*	06*/13*	06	06	06	06	06*/08*	06*/08*	04/03/06•	04/03/06•	03*/06•
VGA Module												
Different Modules						11	11					
Different Modules												
Different Modules												
Different Modules												
Different Modules												
Different Modules												
Different Modules												
Different Modules												
Different Modules												
Different Modules												
Remote Control	11	11	02	02*	06	12	12	11	02	11	11	11
Remote Control retrofitable			10	06*	10	05	05			04	04	14
retrofitable						01	01			08	08	19
retrofitable						10	22			14	14	08
retrofitable												
retrofitable												
MI	98	98	99	00	00	00	01	98	98	99	01	98

*/**/****/•/••/•••/°/°°/# see page 2.16

Set	CUC															
	2031F	2062F	2062N	2080N	2080F	2080N	2080N	2080	2080F	1931	1836	1836	1836	1832	1836	1832
Control Unit		58	58	12			12	12	12	25				17	60	17
CRT Panel	40	45	45	45	43	43	45	43	45	46	36	36	36	44	58	44
Socket Board	04									13;17;19	07	07	07	37		
EPG-Platte										03••				01		01*
Dyn. Focus, Feature Box										05				07		
Keyboard	06	19	19				09	09	09	14/17*	08	08	08	13	21	13
Mains Switch Board	04													13	34	15
Mains Unit										06				03		06
AF Module										31				24		32
East/West PIP Module										09		04				
Processor Board			34	18						17/20*				10		10/20*
SAT Module																
Signal Module										12/09	01	01	04	08	21	14
Tuner	06*/13*	22	22	06	06*/08*	06*/08*	06*/13*	06	06	06/16	03	03	03	06	23	06
VGA Module																
Different Modules	03	64	64	10			10	11		37•/47•						
Different Modules	26								10							
Different Modules										38						
Different Modules										48						
Different Modules										40						
Different Modules										41						
Different Modules										43						
Different Modules																
Different Modules																
Different Modules																
Different Modules																
Different Modules																
Remote Control	11	33	33	12	11	11	12	12	12	25	15	15	15	16	26	16
Remote Control retrofitable	12		10	01			05	05	10	07				15	23	06
retrofitable				05			01	01	15	11				06	24	07
retrofitable				22			10	10	01					07	25	15
retrofitable														11	27	11
retrofitable															28	
MI	99	02	02	00	98	98	00	00	00	01	98	98	98	00	02	00

*/**/****/•/••/•••/°/°°/# see page 2.16

Set	SYDNEY SE7230 DOLBY (VNM)					SYDNEY SE7240 DOLBY (VNA)			T51-071 (VNX)				T51-1201/5 TOP		T51-3035 text		T51-3050 text (VNM)		
	Basic 3	Basic 3	Basic 3	Basic 3	Basic 3	DIGI 100	DIGI 100												
CUC	1832	1832	1832	1832	1832	1838	1838	7303	7303	7303	12.6	7303	7303	7303					
Control Unit	17	17	17	17	17	32	32												
CRT Panel	46	44	44	46	44	53	53	22	22	22		22	22	22					
Socket Board						25	25												
EPG-Platte		01	01	01	01*														
Dyn. Focus,	06			04															
Feature Box	11		13	11/13	13	21	21												
Keyboard		13																	
Mains Switch Board	10	10	10	10	15	18/20/30/31*	18/20												
Mains Unit	03	03	03	03	06														
AF Module	24/27*	24	26	24/27	26														
East/West PIP Module																			
Processor Board	10	10	10	10	10/20*														
SAT Module																			
Signal Module	08	08	10	10	10	25	17												
Tuner	06	06	06	06	06	23	17	06	06	12*/15*	25	07*/10*	06	06					
VGA Module																			
Different Modules																			
Different Modules																			
Different Modules																			
Different Modules																			
Different Modules																			
Different Modules																			
Different Modules																			
Different Modules																			
Different Modules																			
Different Modules																			
Different Modules																			
Remote Control	16	16	16	16	16	26	26	02	02	02	40	17	02	02*					
Remote Control retrofitable	06	06	06	06	06	23	23												07*
retrofitable	07	07	07	07	07	24	24												
retrofitable	11	15	15	15	15	25	25												
retrofitable		11	11	11	11														
retrofitable																			
MI	99	00	00	00	00	02	01	99	99	99	02	98	99	00					

*/**/****/●/●●/●●●/°/°°/# see page 2.16

Set	CUC															
	7303	7303	7303	7303	7303	7303	2003H	7303	7303	7305	7303	7303F	12.6	7303	7303	
Control Unit																
CRT Panel	22	22	22	22	22	22	08	22	22	22	22	06		35	35	
Socket Board																
EPG-Platte																
Dyn. Focus, Feature Box																
Keyboard																
Mains Switch Board																
Mains Unit										05						
AF Module																
East/West																
PIP Module																
Processor Board							15									
SAT Module																
Signal Module																
Tuner	07*/10*	06	06	06	12*/12*	06	06*/13*	06	06	06	06	07*/10*	25	07*/10*	07*/10*	
VGA Module																
Different Modules							31									
Different Modules																
Different Modules																
Different Modules																
Different Modules																
Different Modules																
Different Modules																
Different Modules																
Different Modules																
Different Modules																
Different Modules																
Remote Control	02*	02	02	02	02	02	24	02*	02*	02*	02*	17	40	17	17	
Remote Control	17*							07*	06*	07*	06*					
retrofitable							16									
retrofitable							17									
retrofitable																
retrofitable																
retrofitable																
MI	98	99	99	99	99	99	99	00	00	00	00	98	02	98	98	

*/**/****/●/●●/●●●/°/°°/# see page 2.16

AL

Set	CUC														
	7303	7303	7303	7303	7303	7303	7303	2003H	2003H	2003H	7303	7303	7303	7303	7303
T55-3035 text (VNX)															
T55-3050 text (VNIM)															
T55-600 text (VNIM)															
T55-731 a text															
T55-805 TEXT/TR (VNIM)															
T55-830 FT/GB (VNA)															
T55-830 FT/IR (VNA)															
T55-830 Multi MegASIS (VNIM)															
T55-830 MULTI/COM (VNIM)															
T55-830 Multi/ICN (VNIM)															
T55-830 text															
T55-830 text (VNA)															
T55-830 text/TR (VNA)															
T55-830 text/TR (VNIM)															
T55-830/4 text															
Control Unit	22	22	22	35	22	22	22	08	08	08	22	22	22	22	22
CRT Panel															
Socket Board									26						
EPG-Platte															
Dyn. Focus,															
Feature Box															
Keyboard															
Mains Switch Board															
Mains Unit								14	07						
AF Module															
East/West															
PIP Module															
Processor Board								15		15					
SAT Module															
Signal Module															
Tuner	06	06	06	07*/10*	06	19	06	06*/13	06	06*/13	07*/10*	06	06	12*/15*	07*/10*
VGA Module															
Different Modules								31	52	31					
Different Modules								32							
Different Modules									54						
Different Modules															
Different Modules															
Different Modules															
Different Modules															
Different Modules															
Different Modules															
Different Modules															
Different Modules															
Remote Control	02	02*	02*	02*	06	7/06	02*	23	31	24	02	02	02	02	02
Remote Control		07*	07*	17*		02*	06*								
retrofittable										16					
retrofittable										17					
retrofittable															
retrofittable															
retrofittable															
MI	99	00	00	98	00	00	00	99	01	99	98	99	99	99	98

*/**/****/●/●●/●●●/°/°°/# see page 2.16

Set	CUC												
	7303	7303	7303	7303	7303	7303	2003	2003	7303F	7303F	7303F	7303F	7303F
Control Unit													
CRT Panel	22	22	22	22	22	22	22	08	22	22	35	22	22
Socket Board													
EPG-Platte													
Dyn. Focus, Feature Box													
Keyboard													
Mains Switch Board													
Mains Unit													
AF Module													
East/West													
PIP Module													
Processor Board								07					
SAT Module								03					
Signal Module													
Tuner	06	06	06	12*/15*	06	12*/15*	06*/08*	06*/13*	07*/10*	06	07*/10*	07*/10*	06
VGA Module													
Different Modules													
Different Modules													
Different Modules													
Different Modules													
Different Modules													
Different Modules													
Different Modules													
Different Modules													
Different Modules													
Different Modules													
Different Modules													
Remote Control	02	07	02*	02	02*	02	02	02	02	02	17	02	02
Remote Control		02*	07		07								
retrofitable													
retrofitable													
retrofitable													
retrofitable													
retrofitable													
MI	99	00	00	99	00	99	98	99	98	00	98	98	99

*/**/****/●/●●/●●●/°/°°/# see page 2.16

Set	CUC					1836	1837	1837	1837	2030N	2130M	2130M	1934	1934	1930	1930	1838	1838	1838
	Basic++	DIGI100	DIGI100	DIGI100															
XENTIA 63 M63-400/8 (VNX)																			
XENTIA 63 M63-420/8 DOLBY (VNA)																			
XENTIA 63 M63-420/8 DOLBY (VNM)																			
XENTIA 63 M63-420/8 DOLBY (VNX)																			
XENTIA 63 ST63-400/4 Dolby (VNM)																			
XENTIA 63 ST63-4101/8 DOLBY (VNA)																			
XENTIA 63 ST63-4101/8 DOLBY (VNM)																			
XENTIA 70 FLAT MFW70-430/8 DOLBY (VNA)																			
XENTIA 70 FLAT MFW70-430/8 DOLBY (VNM)																			
XENTIA 70 FLAT MFW70-490/8 GB/DOLBY (VNM)																			
XENTIA 70 FLAT MFW82-490/9 DOLBY (VNM)																			
XENTIA 72 FLAT MF72-430 DOLBY (VNA)																			
XENTIA 72 FLAT MF72-430 DOLBY (VNM)																			
XENTIA 72 FLAT MF72-430 DOLBY (VNX)																			
Control Unit	19	30	30	30	22	54	40									34	34	34	
CRT Panel	36	49	49	49	41	59	59	54	54	48	48	50/58	50/58	50/58	50/58	50/58	50/58	50/58	
Socket Board						27	27	22	22	19	18								
EPG-Platte										01	01								
Dyn. Focus,								09	09	03	03	10/07	10/07	07					
Feature Box	13/16	19	19	19				18	18	16	16	22	22	22	22	22	22	22	
Keyboard																			
Mains Switch Board										12	12								
Mains Unit	02									06	03								
AF Module						30	30			26	26								
East/West						09/11	09/11												
PIP Module																			
Processor Board						36	32					11/18*	11						
SAT Module																			
Signal Module	04/06°	16	16	20				20	16	10	10	21	15	21					
Tuner	04/03/06•	17	17	17	06	22	06	23	17	06	06	23	17	23					
VGA Module																			
Different Modules								51	51										
Different Modules										44	25								
Different Modules																			
Different Modules												44							
Different Modules												09							
Different Modules																			
Different Modules																			
Different Modules																			
Different Modules																			
Different Modules																			
Remote Control	12	34	27	34	07	34	34	30	30	14	14	30	30	30	30	30	30	30	
Remote Control																			
retrofitable	04	23	23	23				23	23	06	06	23	23	23	23	23	23	23	
retrofitable	08	24	24	24				24	24	07	07	24	24	24	24	24	24	24	
retrofitable	14	25	25	25				25	25	11	11	25	25	25	25	25	25	25	
retrofitable																			
retrofitable																			
MI	01	02	01	02	00	02	01	02	01	01	00	02	01	02					

*/**/***./•/••/•••/°/°°/# see page 2.16

	CUC		Set									
	1838	1838	1838	1838	1935	1935	1935	1935	1935	1935	1931	1931
Control Unit	30	30	30									
CRT Panel	49	49	49	50	50	58	50	50	50	48	48	
Socket Board				22	22	22	22	22	22	18	19	
EPG-Platte										01	01••	
Dyn. Focus,				09	09	15	09	13	09	03	03	
Feature Box	19	19	19	22	22	31	31	31	31	15	15	
Keyboard												
Mains Switch Board										12	12	
Mains Unit										03	06	
AF Module				33	33	33	33	33	33	28	28	
East/West												
PIP Module												
Processor Board										11	11/18*	
SAT Module												
Signal Module	15	20	16	16	16	20	20	20	20	13	13	
Tuner	17	23	17	17	17	23	23	23	23	06	06	
VGA Module												
Different Modules				75	51	75	75	75	75			
Different Modules										25	44	
Different Modules											45	
Different Modules										44		
Different Modules										09		
Different Modules												
Different Modules												
Different Modules												
Different Modules												
Different Modules												
Different Modules												
Different Modules												
Different Modules												
Remote Control	27	27	27	30	30	30	30	30	30	14	14	
Remote Control												
retrofitable	23	23	23	23	23	23	23	23	23	06	06	
retrofitable	24	24	24	24	24	24	24	24	24	07	07	
retrofitable	25	25	25	25	25	25	25	25	25	11	11	
retrofitable												
retrofitable												
MI	01	02	01	02	01	02	02	02	02	00	01	

*/**/****/•/••/•••/°/°°/# see page 2.16

GRUNDIG Tele-Pilot® Remote Control Handsets/Overview - TV Product Range



Personal Remote 10
79642 061 1501



TP 100 C
79642 061 4102
29642 061 4600



TP 110 C
79642 061 4200
79642 061 4202



TP 120 DC
79642 061 0600



TP 140 C
29642 061 4800



TP 150 C
29642 066 0300
29642 066 0400



TP 711
29642 062 0100



TP 712
29642 063 0100



TP 713
29642 063 0400



TP 715 (*Hotel)
29642 062 1102
29642 062 4700
*29642 062 1600



TP 741 C
75955 059 0700



TP 750 C
29642 062 1800
29642 062 1900
29642 062 5100
29642 062 5200
29642 062 5300

TV



TP 751 C
29642 062 5400



TP 800 (*Hotel)
29642 061 0104
*29642 061 0800
*29642 061 1900



TP 800 H (ROOMBASE)
29642 061 5700



TP 800 Hcl
19642 061 5600



TP 810 C
29642 061 1001



TP 815 C
29642 061 1400



TP 850 C
29642 061 0901



TP 900
29642 061 1103



TP 910 C
29642 061 1201



TP 912 C
29642 061 3300



TP 950 C
29642 061 0701



TV Control 1
72011 601 0000

TV



TV Control 2
72011 602 0000

Service and Special Functions Digi 100

Call up the Service Menu:

Button "i" (EASY DIALOG)

Call up the dialogue line:

Buttons "P+" or "P-" -> "OK"

Changing the setting in the dialogue line:

Buttons "L+" or "L-" -> "OK"

Back to previous menu:

"Blue" button

Exit menu:

"i" button

Service menu for retailer (code number)

8500

ATS Reset

Press mains button "ON" while holding down the "L+" button on the TV set.

ATS Start

Start the Auto Tuning System via "Adjust language on screen" -> "Adjust country" -> Satellite (optional).

A pressure on the "OK" button ends the AT search. The ATS bit is not reset.

Resetting the ATS bit without changing the existing channel table:

After ending the channel search with "OK", select channel entry in the channel table, enter the indicated channel again then confirm with "OK".

After storing this setting, the ATS bit is reset.

Electronic Programme Lock (parental lock)

Enter the key sequence "7 0 3 8 5 8 0" to cancel your personal code number.

Software Version Number

Call up the "EASY DIALOG" menu. Pressing the "green" button indicates the software version number.

Flash Programming

It is possible to load the software via the service interface on the Feature Module using the F-Programmer 1.

PIP Position

Press and hold down the "PIP" button on the remote control while switching the set on with the mains switch. This activates the PIP mode.

Adjust the horizontal and vertical position.

Using the Format button, you can change the upper right/left and bottom right/left PIP position.

Press "OK" to save the position.

I²C Bus, IC Test

In this fault finding programme, the CIC80050 processor scans the individual modules or circuits connected to the I²C bus and indicates them as countable flashing sequence on the LED of of keyboard control unit.

Press and hold down "P+" on the TV set and switch the TV set on with the mains button.

The number of flashing pulses indicates the defective module according to the table.

With the "L+" button on the TV set it is possible to find out further defective interfaces.

Entry of Letters

Call up the "Letter entry" menu via "EASY DIALOG" -> "Installation" -> "Special functions".

You may select between "off", "on" and "mix" for the programme selection letter entry.

Visible or Invisible "Sound scale" for all Programmes

Call up the "Sound scale" menu via "EASY DIALOG" -> "Installation" -> "Special functions".

Switching on with Programme "1", or automatically

Call up the "Switching on" menu via "EASY DIALOG" -> "Installation" -> "Special functions".

Set the option "Programme position 1" or "automatic".

"Megalogic Info"

Call up the "Megalogic Info" menu via "EASY DIALOG" -> "Installation" -> "Special functions".

The Megalogic control can be switched to "on" or "off".

Status Indication

Call up the "Status indication" menu via "EASY DIALOG" -> "Installation" -> "Special functions".

You may select the position (top, bottom or off) where the information about the sound mode and the picture format is displayed.

Automatic Volume

Call up the "Autom. volume" menu via "EASY DIALOG" -> "Installation" -> "Special functions".

Noise Reduction P1...99 or P1...199

Call up the "Noise reduction P. 1...99" menu via "EASY DIALOG" -> "Installation" -> "Special functions". For the programmes 1...99 or 1...199 you may set the noise reduction to "off", "low", "automatic" or "manual".

Picture Sharpness P1...99 or P1...199

Call up the "Picture sharpness" menu via "EASY DIALOG" -> "Installation" -> "Special functions".

The picture sharpness is set for all programmes.

Colour Match

Call up the "Colour match" menu via "EASY DIALOG" -> "Installation" -> "Special functions".

The colour match (luma delay) is set for every programme.

On sets with PIP module, the colour match for the PIP picture can be set individually.

Rotation

Call up the "Rotation" menu via "EASY DIALOG" -> "Installation" -> "Special functions".

Adjust the display angle of the picture with respect to the picture to zero.

Format Switching with Evaluation of the Switching Voltage

Depending on the voltage present on Pin 8 of the active EURO-AV socket, the set adjusts the picture format. In AV mode, the picture format switching is active for the AV socket (AV 1, AV 2, AV 3).

Picture Screen Geometry

Call up the "Picture screen geometry" menu via "EASY DIALOG" → "Installation" → "Only for the retailer" → "8500".

White Balance

Call up the "White balance" menu via "EASY DIALOG" → "Installation" → "Only for the retailer" → "8500" → "Picture settings".

Adjust the values for "red", "green" and "blue" so that a white picture is obtained.

Switching the Blue Screen Background On and Off

Call up the "Blue screen" menu via "EASY DIALOG" → "Installation" → "Only for the retailer" → "8500" → "Picture settings".

Select "on" or "off".

Watchdog On/Off

Call up the "Watchdog" menu via "EASY DIALOG" → "Installation" → "Only for the retailer" → "8500" → "Special functions".

Set the Watchdog to "off" or "on".

IR Data Programmer

Call up the "IR-Data programmer" menu via "EASY DIALOG" → "Installation" → "Only for the retailer" → "8500" → "Special functions". Using the "OK" button, it is possible to store up to 99 programme positions with data for channel, TV standard, Peri, 6-position station name, centre fine tuning, and "0" volume offset, with the help of the IR data programmer.

Picture Tube Type

Call up the "Picture tube type" menu via "EASY DIALOG" → "Installation" → "Only for the retailer" → Code number "8500" → "Special functions".

Select the appropriate picture tube type.

Hosiden Socket

Call up the "Hosiden socket" menu via "EASY DIALOG" → "Installation" → "Only for the retailer" → Code number "8500" → "Special functions".

Select "yes" or "no".

Subwoofer

Call up the "Subwoofer" menu via "EASY DIALOG" → "Installation" → "Only for the retailer" → Code number "8500" → "Special functions".

Select "yes" or "no".

AGC Setting

Feed in a standard channel raster without finetuning in band 1.

Call up the "AGC setting" menu via "EASY DIALOG" → "Installation" → "Only for the retailer" → Code number "8500" → "Special functions".

Clearing the TV-Guide Flash

Call up the "Clear TV-Guide Flash" menu via "EASY DIALOG" → "Installation" → "Only for the retailer" → Code number "8500" → "Special functions".

Pressing the "OK" button will clear the TV-Guide Flash.

Teletext Level 2.5 Support

Call up the "Teletext Level 2.5" menu via "EASY DIALOG" → "Installation" → "Only for the retailer" → Code number "8500" → "Special functions".

Select "yes" or "no".

IF Type

Call up the "IF type" menu via "EASY DIALOG" → "Installation" → "Only for the retailer" → Code number "8500" → "Special functions".

After replacing the NVM on the Signal module, it is necessary to adjust the IF type:

Inland sets:	Inland
Multi-8 sets:	Multi 8
Multi-9 sets:	Multi 9

SAT Preprogramming

Call up the "SAT preprogramming" menu via "EASY DIALOG" → "Installation" → "Only for the retailer" → Code number "8500" → "Special functions".

Press "OK" for confirmation.

Sound Settings

Press the "blue" button to call up the "Sound settings" menu.

The settings "Voice", "Music", or manual can be selected in the "Presettings" menu.

The "manual" setting allows you to adjust the sound to suit your taste. For the other settings, specific values are preprogrammed.

Picture Settings

Press the "red" button to call up the "Picture settings" menu.

In the "Presettings" menu, the settings "During the day", "In the evening", and "manual" can be selected.

With the "manual" option, you may set the contrast and the picture sharpness. For the other settings, specific values are preprogrammed.

Forced Settings in Programme Mode

Call up the "Sound channel" menu via "EASY DIALOG" → "Programme chart" → "green" button → "Change channel settings".

You may select between "autom.", "Mono", "Mono B" and "Mono C".

Mono B = Original sound track

Mono C = For digital sound reception (Nicom).

Service and Special Functions CUC 2000

ATS Reset

Press the power "ON" button while pressing button ► on the Remote Control → LANGUAGE SELECTION → OK.
Pressing the "TXT" button stops the ATS function.

Loading the Average Values / Emergency Data Set (ROM Data)

Press and hold the ▼ button on the Remote Control and switch on with the mains button. After replacement of IC82005 (NVM) for example, the TV set is started with the emergency data set.

Cancelling the Parental Lock

To cancel the parental lock enter the number 7038.

Switching on with Programme "1" or "AV"

Reach "TV on with" menu with button "i" via "DIALOG CENTER" → "SPECIAL FUNCTIONS". In "AV1" position the TV starts showing the AV picture.

Picture/Sound Options On or Off for all Programmes

Reach the "Pict./sound opt." menu via "DIALOG CENTER" → "SPECIAL FUNCTIONS" by pressing button "i".

Automatic Volume Limiter

Reach the "Volume Limiter" dialog via "DIALOG CENTER" → "SPECIAL FUNCTIONS" by pressing button "i".

Decoder Settings for Individual Programme Positions

By pressing button "i" call up the "Decoder Pxx" dialog via "DIALOG CENTER" → "SPECIAL FUNCTIONS". With the ► or ◀ button it is possible to set the decoder bit on a per-programme basis.

Activating or Deactivating the Economy Mains Switch

Reach the "Economy mains switch" menu with button "i" via "DIALOG CENTER" → "SPECIAL FUNCTIONS". With the ► or ◀ button select "1h...3h".

Picture Settings

Call up the picture settings menu with the "red" button (eye). Via the menu guide it is possible to change the contrast, picture sharpness and tint (only NTSC sources).

The analog values for contrast, picture sharpness and tint are stored automatically when leaving the menu.

Sound Switching:

Call up the sound settings menu with the "blue" button (ear). Different types of sounds are available dependent on the TV standard.

The forced-mono, balance, bass, treble and similar values are stored automatically when leaving the menu.

Headphone Sound Switching

Call up the sound settings menu with the "blue" button. Dependent on the TV standard, different settings are possible for the headphones.

With all other options, separate selection of the sound for the headphones and loudspeakers is not possible.

Maximum Programme Number (reversing point)

Call up the programme number which is to be the highest selectable programme position. With button "i" select the dialog line "MANUAL TUNING" via the "DIALOG CENTER". Following the menu guide, enter "00" in the dialog line. Confirm with "OK" and terminate the menu.

AFC Control

The two used programme positions before the reversing point are provided with an AFC control (video recorder via HF).

Decoder P1...99 (90° sets)

By pressing button "i" call up the dialog line "Decoder (P1-99)" via "DIALOG CENTER" → "SERVICE". With the ► or ◀ button it is possible to set or reset the decoder bit in the EEPROM for all programme positions.

Decoder P1...79 (110° sets)

By pressing button "i" call up the dialog line "Decoder (P1-79)" via "DIALOG CENTER" → "SERVICE". With the ► ◀ buttons it is possible to set an analog or digital decoder to be switched over internally or externally on the programme positions 1...79 for scrambled stations.

Possible decoder settings are: "Manual", "off", "ON1", "ON2", "ON3".

With the "Manual" setting it is possible to select the decoder switching function to be "off" or "ON" for the individual programme positions.

Forced Chroma Switching

Call up the dialog line "Color" via "DIALOG CENTER" → "SERVICE" with button "i". With the buttons ► ◀ it is possible to force the automatic chroma standard switching function into "PAL", "SECAM" or "NTSC" on a per-programme basis under poor reception conditions.

Switching off the Blue Screen Background

Call up the dialog line "Blue Screen" via "DIALOG CENTER" → "SERVICE" with button "i". When this function is set to "off" the blue background is switched off.

Black Screen when Changing the Programme

Call up the dialog line "Black Screen" via "DIALOG CENTER" → "SERVICE" with button "i". When this function is set to "on" the screen is blanked when changing the programme.

Display of the Station Name On or Off

The station ident is read out from VT (teletext) or the VPS signal.

Call up the dialog line "Station name" via "DIALOG CENTER" → "SERVICE" with button "i". With this function set to "off" it is possible to avoid the station name being displayed on the screen for a short time when changing the programme.

Group Delay Time / Setting the National Standards

Call up the dialog line "B/G FM 5.5 NIC" via "DIALOG CENTER" → "SERVICE" with button "i". Select the standard corresponding to the country where the set is operated.

IDP2

Call up the dialog line "IDP2 HP" via "DIALOG CENTER" → "OK" → "SERVICE" → "OK" with button "i". The characters change to red.

Service Menu

Call up the Service Menu with button "i" via "DIALOG CENTER" → "SERVICE" → Service Code. Having entered the code number "8500" the dealer can change the settings under menu guide.

OSD Position

Call up the dialog line "OSD" with button "i" via "DIALOG CENTER" → "SERVICE" → Service Code "8500".

With the ► ◀ buttons it is possible to shift the on screen display in the horizontal or vertical direction and to store this position "with mem.".

Activating the Hotel Mode

Call up the dialog line "Hotel" with button "i" via "DIALOG CENTER" → "SERVICE" → Service Code "8500".

Deactivating the Hotel Mode

Depress and hold button "i" on the remote control handset while switching the TV set on with the mains switch. Under the "SERVICE" menu switch the Hotel Mode off.

Deactivating the Protection Circuit

Depress and hold button "i" on the remote control handset while switching the TV set on with the mains switch. As long as the Service Menu is displayed the protection circuit of the TV set is not evaluated on video processor IC34015-(50).

Setting the Analog Values

The analog values are stored automatically: after about 8 seconds,

on switching to Standby mode,
on switching over from TV to AV mode,
on changing the individual AV settings.

Having stored the minimum volume level the volume indicator bar is displayed for about 10 seconds when switching the TV receiver on.

With "AUX" → "OK" it is possible to re-set the optimum values for picture and sound.

The optimum values are read out from EEPROM IC82005.

Service and Special Functions CUC 2100

ATS Reset

Press the power "ON" button while pressing button "L+" on the Remote Control → LANGUAGE SELECTION → "OK". Pressing the "TXT" button stops the ATS function.

Loading the Average Values / Emergency Data Set (ROM Data)

Press and hold the "P-" button on the Remote Control and switch on with the mains button. After replacement of CIC82501 (NVM) for example, the TV set is started with the emergency data set.

Cancelling the Parental Lock Continuously

To cancel the parental lock enter the number 7038.

EPROM Version Number

With the Remote Control "0" setting in the menu for the specialized dealer (TP750):

Press button "i" to call up the "Dialog Center" → OK. Button "AUX" shows the version number of the EPROM.

With the Remote Control "1" setting in the menu for the specialized dealer (TP150C):

Press button "i" to call up the "Dialog Center". Button "AUX" shows the version number of the EPROM.

Switching on with the Last Viewed Programme.

The channel position which has been selected when switching off is recovered when switching on again (last station memory).

Activating or Deactivating the Economy Mains Switch (option)

Reach the "Economy mains switch" menu with button "i" via "Dialog Center" → "Special functions". With the buttons ► ◀ select "1h...3h".

Sound Scale or Picture/Sound Settings

With the Remote Control "1" setting in the menu for the specialized dealer (TP150C):

Reach the "Sound scale" menu with button "i" via "Dialog Center" → "Special functions".

With the Remote Control "0" setting in the menu for the specialized dealer (TP750):

Reach the "Picture/Sound settings" menu with button "i" via "Dialog Center" → "Special functions".

Automatic Volume Control (option)

Reach the "Volume Limiter" dialog via "Dialog Center" → "Special functions" by pressing button "i".

With the "Dolby Surround" setting in the Sound menu, this function is deactivated.

Picture Settings

Call up the picture settings menu with the "red" button (eye). Via the menu guide it is possible to change the Brightness, Color, Contrast, Sharpness, Perfect Clear and tint (only NTSC sources).

The analog values for contrast, picture sharpness and tint are stored automatically when leaving the menu.

Sound Switching:

Call up the sound settings menu with the "blue" button (ear). Different types of sounds are available dependent on the TV standard.

The forced-mono, balance, bass, treble and similar values are stored automatically when leaving the menu.

Headphone Sound Switching

Call up the sound settings menu with the "blue" button. Dependent on the TV standard, different settings are possible for the headphones.

Maximum Programme Number

Call up the programme number which is to be the highest selectable programme position. With button "i" select the dialog line "MANUAL TUNING" via the "DIALOG CENTER". Following the menu guide, enter "C 00" in the dialog line channel. Confirm with "OK" and terminate the menu.

Factory Settings

Press the "i" button to select the "Factory settings" dialog line via "Dialog Center" → "Service".

Use the "OK" button on the remote control to call up the factory settings (NVM) and to store them.

Forced Chroma Switching

Call up the dialog line "Color" via "Dialog Center" → "Service" with button "i". With the buttons ◀ ► it is possible to force the automatic chroma standard switching function into "PAL", "SECAM" or "NTSC 3.6" or "NTSC 4.4" on a per-programme basis under poor reception conditions.

IR Data Programmer

Call up the dialog line "IDP2 HP" via "Dialog Center" → "Service" with button "i".

Using the "OK" button, it is possible to store up to 99 programme positions with data for channel, TV standard, Peri, 6-position station name, centre fine tuning, and "0" volume offset, with the help of the IR data programmer 2.

Decoder P1...99

By pressing button "i" call up the dialog line "Decoder (P1-99)" via "DIALOG CENTER" → "SERVICE". With the ► ◀ buttons it is possible to set an analog or digital decoder to be switched over internally or externally on the programme positions 1...99 for scrambled stations.

Service Menu

Call up the Service Menu with button "i" via "Dialog Center" → "Service" → Service Code.

Having entered the code number "8500" the dealer can change the settings under menu guide.

OSD Position

Call up the dialog line "OSD" with button "i" via "Dialog Center" → "Service" → Service Code "8500".

With the ◀ ► buttons it is possible to shift the on screen display in the horizontal or vertical direction and to store this position "with mem."

Activating the Hotel Mode

Call up the dialog line "Hotel" with button **i** via "Dialog Center" → "Service" → Service Code "8500".

Deactivating the Hotel Mode

Press and hold button **i** on the remote control handset while switching the TV set on with the mains switch. Under the "Service" menu switch the Hotel Mode off.

Remote Control

Call up the dialog line "Remote cont." with button **i** via "Dialog Center" → "Service" → Service Code "8500".

TP 150C (36kHz) = "1"

TP 750 (30kHz) = "0"

Luminosity of the Operating Mode LED

Call up the dialog line "End" with button **i** via "Dialog Center" → "Service" → Service Code "8500".

Use the **red** (minus) and **green** (plus) buttons on the remote control to adjust the LED luminosity in normal operating mode.

Use the **yellow** (minus) and **blue** (plus) buttons on the remote control to adjust the LED luminosity in standby mode.

Deactivating the Protection Circuit

- Horizontal and vertical protection circuit: connect the basis and emitter at CT50055.
 - Horizontal protection circuit: connect the basis and collector at CT57113.
 - Vertical protection circuit: to short out C50052.
- Attention: When the repair is completed, it is absolutely necessary to activate the overload protection circuits.

Service and Special Functions Digi 6

ATS Reset and Demo Mode

Press and hold button "L+" on the TV and switch the mains button "ON".

1x mains on: Demo Mode is activated. Short-time deactivation is possible with "P-" and reactivation with "P+".

2x mains on: Demo Mode ("Demo off") is switched off and ATS is activated (indication "ATS Reset" appears).

Pressing the "TXT" button stops the ATS function without storing any data.

Initialising the Processor

By connecting pin 10 and pin 12 of the Scart socket after replacement of the processor, the internal EEPROM is loaded thus initialising the processor.

Loading the Average Values / Emergency Data Set (ROM Data)

This is only possible once on replacement of the NVM or μ P.

By pressing and holding the "P-" button on the TV and switching on with the mains button after replacement of IC87080 (NVM) the TV set is started with the emergency data set.

Service Mode Programme (for fault finding in the I²C bus)

Press and hold the "P+" button on the TV set and switch on with the mains button.

The "L+" button on the TV set allows to discover other potentially defective interfaces. If there are no other defective interfaces the software tries to start the TV set.

SAT Module Programmierung

Press and hold the "i" button on the remote control and switch the TV on with the mains switch. Consequently, on replacement of the EEPROM on the SAT Module for example, the stored station table is read out from EPROM IC87030.

PIP Adjustment

Press and hold the "PIP" button on the remote control and switch the TV on with the mains switch. In doing so, with built-in PIP Module, the PIP Adjustment Mode is called up. Using the \blacktriangleright \blacktriangleleft \blacktriangledown \blacktriangleup buttons the PIP position can be changed via the menu and stored with "OK".

Cancelling the Parental Lock

To cancel your personal code number press the buttons \blacktriangleright \blacktriangleleft \blacktriangledown \blacktriangleup in this order.

EPROM Version Number

Press button "i" to call up the "DIALOGCENTER" menu. The version number is shown by pressing the "AUX" button. The index 07 of the part number (19798-311.07) indicates the EPROM version.

Activating or Disactivating the Economy Mains Switch

Reach the "Economy mains switch" menu with button "i" via "DIALOGCENTER" \rightarrow "SPECIAL FUNCTIONS". With the buttons \blacktriangleright \blacktriangleleft select "off" or "1h...4h".

Switching on with Programme "1" or "AV"

Reach "Switch on with" menu with button "i" via "DIALOGCENTER" \rightarrow "SPECIAL FUNCTIONS". With the buttons \blacktriangleright \blacktriangleleft select "Prog" or "AV".

Picture/Sound Options On or Off for all Programmes

Reach the "Pict./sound scales" menu via "DIALOGCENTER" \rightarrow "SPECIAL FUNCTIONS" by pressing button "i".

"Megalogic-Info"

Reach the "Megalogic-Info" menu via "DIALOGCENTER" \rightarrow "SPECIAL FUNCTIONS" by pressing button "i".

Switching off the Blue Screen Background

Reach "Only for the retailer" via "DIALOGCENTER" \rightarrow "SERVICE" \rightarrow Code Number 8500 pressing button "i". Press the "yellow" button.

Colour Match for Normal and PIP picture

Reach the "Colour match" menu via "DIALOGCENTER" \rightarrow "SERVICE" pressing button "i". With the buttons \blacktriangleright \blacktriangleleft the luma delay is set on a per-programme basis.

COLORplus-Menü

Reach the "COLORplus" menu via "DIALOGCENTER" \rightarrow "SERVICE" pressing button "i". Use the \blacktriangleright \blacktriangleleft buttons to change the COLORplus identification to "Off" or "Auto".

Blackline Detector

Reach the "Blackline-Detect." menu via "DIALOGCENTER" \rightarrow "SERVICE" pressing the "i" button. Use the \blacktriangleright \blacktriangleleft buttons to set "Blackline-Detect." to "Off" or "Auto".

PALplus Menu

Call up the "PALplus-Menu" with button "i" via "DIALOGCENTER" \rightarrow "SERVICE" \rightarrow "Only for the retailer". The buttons \blacktriangleright \blacktriangleleft \blacktriangledown \blacktriangleup allow to change the PALplus-Menu only temporarily. PALplus receivers are delivered with "On" as a standard setting.

Noise Reduction P1...99 or 1...179

Reach the "Noise reduct." menu via "DIALOGCENTER" \rightarrow "SERVICE" pressing button "i". With the buttons \blacktriangleright \blacktriangleleft the noise reduction can be set to "Off", "weak", or "Auto" for all of the programmes 1...99 or 1...179 (with SAT module).

Decoder P1...99 or 1...179

Call up the "Decoder" menu with the "i" button via "DIALOGCENTER" \rightarrow "SERVICE". With the buttons \blacktriangleright \blacktriangleleft it is possible to switch the decoder to "Off" or "On" for all programmes.

Decoder P X for Coded Transmissions

Call up the "Decoder Sound P." menu with button "i" via "DIALOGCENTER" \rightarrow "SERVICE". With the \blacktriangleright \blacktriangleleft buttons it is possible to set an analog or digital decoder for coded transmissions to internal or external on a per-programme basis.

Service AV Connections

Call up the "Service AV connections." menu with button "i" via "DIALOGCENTER" -> "SERVICE". With the ► ◀ and ▲ ▼ buttons it is possible to switch over the signal type according to the menu guide.

With the ► ◀ buttons the decoder priority can be changed to "low", "high" or "Off".

Automatic Presentation

Call up the "Automatic presentation" menu with button "i" via "DIALOGCENTER" -> "SERVICE ". Start the automatic presentation of the TV set with the "OK" button. Switch the TV set off with the mains button or the local "P+" or "P-" button. Deactivate with ATS Reset 1.1.

IR Data Programmer

Reach the "IR-Dataprogrammer" menu via "DIALOGCENTER" -> "SERVICE" pressing button "i". The IR Data Programmer 2 makes it possible to store a maximum of 99 programme positions with the data for channel, TV standard, Peri, 4-place station identification, fine tuning center frequency, and the volume offset "0" using the "OK" button.

Switching on with the Test Pattern or TV Mode

Call up the menu "Switch on with test pattern or TV", with the "i" button via "DIALOGCENTER" -> "SERVICE".

Only for the Retailer

Call up the menu "Only for the retailer" with the "i" button via "DIALOGCENTER" -> "SERVICE" and confirm with the "OK" button. When entering the code number "8500" the dealer can adjust the TV set according to the menu.

Sound Switching

Call up the "SOUND SETTINGS" menu with the "blue" button. Different types of "Sound" are available dependent on the TV standard.

Headphone Sound Switching

Call up the "SOUND SETTINGS" menu with the "blue" button. Dependent on the TV standard, different settings are possible under "HP-sound change over".

Setting the Volume on a Per-Programme Basis

Call up the "SOUND SETTINGS" menu with the "blue" button. The volume can be set for each individual programme position with "Volume P ." (volume offset).

Sound Effects Pro Logic Phantom

Call up the "SOUND SETTINGS" menu with the "blue" button.

Under "Sound effects" different Dolby sound effects and loudspeaker settings can be selected with the buttons ► ◀ and ▲ ▼ via the menu.

Basic Picture Settings

Call up the "PICTURE SETTINGS" menu with the "red" button. Via the menu guide, the following options can be selected: "Personal", "During the day", "In the evening" and "Soft".

Picture Sharpness

Call up the "PICTURE SETTINGS" menu with the "red" button and select "Sharpness P."

The picture sharpness can be changed in three steps with the ► ◀ buttons.

Perfect Clear

With the "red" button call up the "PICTURE SETTINGS" menu and select "Perfect Clear".

With the ► ◀ buttons this function can be switched on or off.

Comb Filter

Call up the "PICTURE SETTINGS" menu with the "red" button and select "Comb filter".

The comb filter can be set to "Off" or "Auto" on each programme position using the ► ◀ buttons.

Line Flicker Reduction

Call up the "PICTURE SETTINGS" menu with the "red" button and select "Line flicker reduct.".

With the ► ◀ buttons the setting can be changed to "Off" or "Auto".

Noise Reduction P . (on individual programme positions)

With the "red" button call up the "PICTURE SETTINGS" menu and select "Noise reduct.".

With the ► ◀ buttons it is possible to select the settings "Off", "Auto", "High!" and "weak" for each individual programme position. The µP stores the settings "Off", "weak" and "Auto" when leaving the menu. The option "High!" can be selected only temporarily.

Maximum Programme Number (reversing point)

Call up the "TV-PROGRAMME-CHART" menu via "DIALOGCENTER" pressing the "i" button.

When entering the channel number "00" on any programme position of the TV programme chart and entering "00", programme selection with the buttons ▲ ▼ is limited to the numbers lower than this position.

Settings via the Station Ident

Call up the "TV-PROGRAMME-CHART" menu via "DIALOGCENTER" -> "OK" using button "i" and activate the desired TV station.

The forced operating modes for the individual programme positions must be entered into the last 3 places of the station identification beginning with a comma so that the first three places "X" are still left for the actual station identification.

Forced Settings in AV Mode (AV1...AV4)

Press the "i" button to call up the "TV-PROGRAMME-CHART" menu via "DIALOGCENTER". Select the AV level with button ◀, call up the desired AV programme and activate with the "blue" button.

Setting the Analog Values

State of delivery is after execution of ATS (optimum value).

When exceeding the minimum possible analog values (maximum value is 63), the optimum value is initialised when switching the TV on or changing from RF -> AV.

Changing the Picture Format

The picture format can be switched over with remote control button "E" in dependence of the size of the picture tube. PALplus appears only if it was previously identified automatically.

In "auto" mode, the format is automatical changed accordingly with every change of the status in dependence of the transmitter information (WSS).

Service and Special Functions Digi Basic, Digi Basic +

ATS Reset

Press and hold button "L+" on the TV and switch the mains button "ON".

ATS Start

In the menu → "Adjust language on screen" → "Adjust country" → press the "OK" button, the Auto Tuning System (ATS) starts.

Pressing the "TXT" button stops the ATS function without storing any data.

Loading the Average Values / Emergency Data Set (ROM Data)

This is only possible once on replacement of the NVM or µP.

After replacement of IC80065/IC80070 (NVM) the TV must be started with the emergency data set.

Press and hold the "P-" button on the TV and switch on with the mains button.

Service Mode Programme

These error messages refer only to interferences in the I²C bus, that is to those modules or integrated circuits which do not return an Acknowledge bit via the I²C bus, for example to indicate that there is no operating voltage present on the module, that there is a break in the circuit path or that the I²C interface is defective.

Parental Lock (electronic programme lock)

To cancel your personal code number press the buttons ► ◀ ▼ ▲ in this order.

EPROM Version Number

Press button "i" to call up the "Dialog Center" → OK. The version number is shown by pressing the "AUX" button. The index 01 of the part number (19798-300.01) indicates the EPROM version.

Activating or Disactivating the Mains Economy Switch

Reach the "Mains economy sw." menu with button "i" via "Dialog Center" → "Special functions". With the buttons ► ◀ select "off" or "1h...4h".

Switching on with Programme "1" or "AV"

Reach "Switch on with" menu with button "i" via "Dialog Center" → "Special functions". With the buttons ► ◀ select "Progr" or "AV".

Picture/Sound Options On or Off for all Programmes

Reach this menu via "Dialog Center" → "Special Functions" by pressing button "i". When selecting "off" the scales indicating the analog values do not appear.

Switch off blue background of screen

Reach the "for authorised dealer" menu via "Dialog Center" → "Service" → Code Number 8500 pressing button "i". Press "yellow" button. After switching over the programme, the blue background is switched off.

Colour Match

Reach the "Colour match" menu via "Dialog Center" → "Service" pressing button "i". With the buttons ► ◀ the luma delay is set on a per-programme basis.

Noise Reduction

Reach the "Noise reduct." menu via "Dialog Center" → "Service" pressing button "i". With the buttons ► ◀ the noise reduction can be set to "Off" or "Auto" for all of the programmes 1...99.

IR Data Programmer

Reach the "IR-Dataprogrammer" menu via "Dialog Center" → "Service" pressing button "i". The IR Data Programmer 2 makes it possible to store a maximum of 99 programme positions with the data for channel, TV standard, Peri, 4-place station identification, fine tuning center frequency, and the volume offset "0" using the "OK" button.

AFC Reference

Tune to a station in band I with standardized channel raster and without fine tuning. Reach the "AFC reference" menu via "Dialog Center" → "Service" → "for authorised dealer" → Code Number 8500 pressing button "i". On pressing the "OK" button the automatically determined AFC value is indicated.

White Balance

Reach the "White bal." menu via "Dialog Center" → "Service" → "for authorised dealer" → Code Number 8500 pressing button "i". The values for "green" and "blue" can be adjusted with the ► ◀ buttons.

Bottom Flutter Gate

Reach the "Bottom flutter gate" menu via "Dialog Center" → "Service" → "for authorised dealer" → Code Number 8500 pressing button "i". The value can be changed in 3 steps.

Type of Picture Tube

Via "Dialog Center" → "Service" → "for authorised dealer" → Code Number 8500 → "Tube type", the type of tube is set in the factory.

RGB Synchronising Level

Reach the "RGB-Sync. level" menu via "Dialog Center" → "Service" → "for authorised dealer" → Code Number 8500 pressing button "i". You can select the RGB sync level to be "on" or "off" in RGB mode.

Geometry

Reach the "Geometry" menu via "Dialog Center" → "Service" → "for authorised dealer" → Code Number 8500 pressing button "i". Adjust the picture geometry with the geometry test pattern.

Sound Switching:

Call up the "Sound settings" menu with the "blue" button. Different types of "Sound" are available dependent on the standard.

Headphone Sound Switching

Call up the "Sound settings" menu with the "blue" button. Dependent on the TV standard, different settings for the "Headphones" are possible.

Setting the Volume on a Per-Programme Basis

Call up the "Sound settings" menu with the "blue" button. The volume can be set for each individual programme position with "Volume P X".

Basic Picture Settings

Call up the "Picture settings" menu. Via the user's guide, the following options can be selected: "Personal", "During the day", "In the evening" and "Soft".

Perfect Clear

With the "red" button call up the "Picture settings" menu and select "Perfect Clear".

With the ► ◀ buttons this function can be switched on or off.

Noise Reduction

With the "red" button call up the "Picture settings" menu and select "Noise reduct.".

With the ► ◀ buttons it is possible to select the settings "Off", "Auto", and "High!". The μ P stores the settings "Off" and "Auto" for the individual programme position when leaving the menu. The option "High!" can be selected only temporarily.

Maximum Programme Number (reversing point)

Call up the "TV-Programme-Chart" menu via "Dialog Center" pressing the "i" button.

When entering the channel number "00" on any programme position by pressing the "P/C" button and entering "00", programme selection with the buttons ▲ ▼ is limited to the numbers lower than this position.

Settings via the Station Ident

Call up the "TV-Programme-Chart" menu via "Dialog Center" using button "i" and activate the desired TV station.

The forced operating modes for the individual programme positions must be entered in to the last 3 places of the station identification beginning with a comma so that only one place "X" is left for the actual station identification.

Forced Settings in AV Mode (AV1...AV3)

Press the "i" button to call up the "TV-Programme-Chart" menu via "Dialog Center". Move the yellow bar to "AV", select the desired AV level and activate with the "blue" button.

Setting the Analog Values

When exceeding the minimum possible analog values (maximum value is 63), the optimum value is initialised when switching the TV on or changing from RF → AV.

Service and Special Functions Digi Basic ++

ATS Reset

Press and hold button "L+" on the TV and switch the mains button "ON".

ATS Start

In the menu → "Adjust language on screen" → "Adjust country" → press the "OK" button, the Auto Tuning System (ATS) starts.

Pressing the "TXT" or "i" button stops the ATS function.

Loading the Average Values / Emergency Data Set (ROM Data)

This is only possible once on replacement of the NVM or µP.

After replacement of IC80065/IC80070 (NVM) the TV must be started with the emergency data set.

Press and hold the "P-" button on the TV and switch on with the mains button.

Resetting Volume Offsets

Depress and hold the "AUX" button on the remote control handset and switch on with the mains button. All volume offsets are reset to "0".

Calling up the SERVICE Menu "for authorised dealer"

Depress and hold the "i" button on the remote control handset and switch on with the mains button. With this menu it is possible for the dealer to adjust the television receiver.

Parental Lock (electronic programme lock)

To cancel your personal code number enter "7 0 3 8" in this order.

EPROM Version Number

Press button "i" to call up the "DIALOG CENTER" → OK. Button "AUX" shows the version number of the EPROM.

PIP Position

Depress and hold the "PIP" button on the remote control handset and switch on with the mains button to call up the PIP Mode. Following the menu guide the PIP position can be changed with the buttons ► ◀ ▼ ▲ and stored with "OK".

Activating or Deactivating the Mains Economy Switch

Reach the "Mains economy sw." menu with button "i" via "DIALOG CENTER" → "SPECIAL FUNCTIONS". With the buttons ► ◀ select "off" or "1h...4h".

Switching on with Programme "1" or "AV"

Reach the "Switch on with" menu with button "i" via "DIALOG CENTER" → "SPECIAL FUNCTIONS". With the buttons ► ◀ select "Progr" or "AV".

Picture/Sound Options On or Off for all Programmes

Reach this menu via "DIALOG CENTER" → "SPECIAL FUNCTIONS" by pressing button "i".

"Megalogic Info"

Reach the "MEGALOGIC Info" menu via "DIALOG CENTER" → "SPECIAL FUNCTIONS" by pressing button "i". With the buttons ► ◀ the Megalogic control can be switched on or off.

"Timer function"

Appears only if a SAT module is identified in the television receiver.

Reach this menu via "DIALOG CENTER" → "SPECIAL FUNCTIONS" by pressing button "i".

AVL (Automatic Volume Limiter)

The indication "Automatic Volume Limiter" appears only if the MSP3410D (IC32300) with AVL function is identified in the set.

Colour Match

Reach the "Colour match" menu via "DIALOG CENTER" → "SERVICE" pressing button "i". With the buttons ► ◀ the luma delay is set on a per-programme basis.

If a PIP Module is retrofitted, select the PIP programme.

Noise Reduction P1...99 or 1...179

Reach the "Noise reduct." menu via "DIALOG CENTER" → "SERVICE" pressing button "i". With the buttons ► ◀ the noise reduction can be set to "off", "weak", "auto" or "manual" for all of the programmes 1...99 or 1...179.

Decoder P1...99 or 1...179

Call up the "Decoder" menu via "DIALOG CENTER" → "SERVICE" with button "i". With the buttons ► ◀ it is possible to switch the decoder "off" or "on" for all programmes.

Picture Sharpness

Call up the "Picture Sharpness" menu with button "i". With the buttons ► ◀ it is possible to adjust the picture sharpness in three steps for all programmes.

Decoder P. for Coded Transmissions

Call up the "Decoder Sound P." menu with button "i" via "DIALOG CENTER" → "SERVICE". With the buttons ► ◀ it is possible to set an analog or digital decoder for scrambled transmissions to internal or external switch-over on a per-programme basis.

IR Data Programmer

Reach the "IR-Dataprogrammer" menu via "DIALOG CENTER" → "SERVICE" pressing button "i". The IR Data Programmer 2 makes it possible to store a maximum of 99 programme positions with the data for channel, TV standard, Peri, 4-place station identification, fine tuning center frequency, and the volume offset "0" using the "OK" button.

Picture Format Selection via Station Ident BLD and WSS

The picture format can be switched over with remote control button "⏏" in dependence of the size of the picture tube.

In "auto" mode, the format is automatically changed accordingly with every change of the status (Wide Screen Signal Bit) via the Black Line Detector in dependence of the transmitter information.

Picture Format Selection with AV Switching Voltage Evaluation

The TV set selects the picture format in dependence of the voltage applied to Pin 8 of the active Scart socket. On AV operation, the format switching function is active for the black and orange AV socket (AV1, AV 2).

IF/ZF 29504-162

Press button "i" to reach the menu "IF/ZF 29504-162" via "DIALOG CENTER" → "SERVICE" → "for authorised dealer" → Code Number "8500". Select the signal module fitted to the TV set.

Switching Off Blue Background of Screen

Press button "i" to reach the menu "for authorised dealer" via "DIALOG CENTER" → "SERVICE" → Code Number "8500". Press the "yellow" button. Switching off the set cancels this function.

AFC Reference

Tune in to a station in band I with standardized channel raster and without fine tuning. Reach the "AFC reference" menu via "DIALOG CENTER" → "SERVICE" → "for authorised dealer" → Code Number "8500" pressing button "i". On pressing the "OK" button the automatically determined AFC value is indicated.

White Balance

Reach the "White bal." menu via "DIALOG CENTER" → "SERVICE" → "for authorised dealer" → Code Number "8500" pressing button "i". The values for "green" and "blue" can be adjusted with the ► ◀ buttons.

Colour Decoder

Call up the "Colour decoder" menu via "DIALOG CENTER" → "SERVICE" → "for authorised dealer" → Code Number "8500" pressing button "i". Select the Colour Decoder fitted to the TV set (VPC3210A/VPC3211A).

Type of Picture Tube

Via "DIALOG CENTER" → "SERVICE" → "for authorised dealer" → Code Number "8500" → "Tube type", the type of tube will be set.

Preprogramming the SAT Module

"SAT preprogramming" via "DIALOG CENTER" → "SERVICE" → "for authorised dealer" → Code Number "8500" → confirm with "OK" button.

Selecting the Software (without PIP Module)

Reach the "GR/OEM" menu via "DIALOG CENTER" → "SERVICE" → "for authorised dealer" → Code Number "8500" pressing button "i". Set the dialog line to GR.

Selecting the Software (with PIP Module)

Software version < 19798-318.30 for multi-system models or < 19798-323.10 for Pal versions.

Press button "i" to reach the menu "GR/OEM PIP 29504-106" via "DIALOG CENTER" → "SERVICE" → "for authorised dealer" → Code Number "8500". Set the dialog line to the appropriate PIP Module (GR .53 or .55).

The menu option "GR/OEM PIP 29504-106" needs not to be changed (xxx.53 / 55) for TV receivers with 1-Tuner-PIP (.54).

Geometry

Reach the "Geometry" menu via "DIALOG CENTER" → "SERVICE" → "for authorised dealer" → Code Number "8500" pressing button "i". Adjust the picture geometry with the geometry test pattern.

Sound Switching:

Call up the "Sound settings" menu with the "blue" button. Different types of "Sound" are available dependent on the standard.

Headphone Sound Switching

Call up the "Sound settings" menu with the "blue" button. Dependent on the TV standard, different settings for the "Headphones" are possible.

Setting the Volume on a Per-Programme Basis

Call up the "Sound settings" menu with the "blue" button. The volume can be set for each individual programme position with "Volume P X" (volume offset).

Basic Picture Settings

Call up the "Picture settings" menu with the "red" button. Following the user guide it is possible to select the options: "Personal", "During the day", "In the evening" and "Soft".

Picture Sharpness

Call up the "Picture settings" menu with the "red" button and select "Picture sharpness".

With the buttons ► ◀ it is possible to set the picture sharpness in four steps for each individual programme.

Perfect Clear

With the "red" button call up the "Picture settings" menu and select "Perfect Clear".

With the ► ◀ buttons this function can be switched on or off.

Noise Reduction

With the "red" button call up the "Picture settings" menu and select "Noise reduct.".

With the ► ◀ buttons it is possible to select the settings "Off", "Auto", and "weak".

Maximum Programme Number (reversing point)

Call up the "TV PROGRAMME CHART" menu via "DIALOG CENTER" pressing the "i" button.

When entering the channel number "00" on any programme position by pressing the "P/C" button and entering "00", programme selection with the buttons ▲ ▼ is limited to the numbers lower than this position.

Forced Settings in Programme Mode

Call up the "TV PROGRAMME CHART" menu via "DIALOG CENTER" using button "i" and activate the desired TV station with the "blue" button.

The forced operating modes for the individual programme positions must be entered into the last 3 places of the station identification beginning with a comma so that only one place "X" is left for the actual station identification.

Forced Settings in AV Mode (AV1...AV3)

Press the "i" button to call up the "TV PROGRAMME CHART" menu via "DIALOG CENTER". Move the yellow bar to "AV", select the desired AV level and activate with the "blue" button.

Setting the Analog Values

The last entered analog values are stored automatically after about 10s or when changing to the AV positions or vice versa. When exceeding the minimum analog values (maximum value is 63), the optimum value is initialised when switching the TV on or changing from RF → AV.

Service and Special Functions Digi Basic 3

ATS Reset

Press and hold button "L+" on the TV and switch the mains button "ON".

ATS Start

The Auto Tuning System (ATS) is started selecting the menu → "Adjust language on screen" → "Adjust country" → pressing the "OK" button.

Pressing the "TXT" or "i" button stops the ATS function. The ATS bit will not be reset.

Resetting the ATS bit without changing the existing channel table:

On stopping the station search function by pressing "TXT" or "i", select "AUX" → "green" button for direct channel entry, detune the finetuning value by one step and reset it. On storing this setting, the ATS bit is reset.

Loading the Average Values / Emergency Data Set (ROM Data)

This is only possible once on replacement of the NVM or µP.

On replacement of CIC80095 (NVM) the TV must be started with the emergency data set.

Press and hold the "P-" button on the TV and switch on with the mains button.

Electronic Programme Lock (parental lock)

To cancel your personal code number enter "7 0 3 8 5 8 0" in this order.

EPROM Version Number

Press button "i" to call up the "DIALOG CENTER" → OK. Button "AUX" shows the version number of the EPROM.

PIP Position

Depress and hold the "PIP" button on the remote control handset and switch on with the mains button to call up the PIP Mode.

Using the buttons ► ◀ the horizontal position can be changed.

Using the buttons ▼ ▲ the vertical position can be changed.

Using the format button, the upper right/left and lower right/left position of the PIP can be changed.

Store the position with "OK".

I²C Bus, IC Test

In this fault finding programme, the microprocessor CIC80050 scans the individual modules or circuits connected to the I²C bus and indicates them as a countable pulse sequence at the LED of the keyboard control unit.

Press and hold "P+" on the TV and switch on with the mains button.

With button "L+" on the TV it is possible to find out further defective interfaces.

Activating or Deactivating the Mains Economy Switch

Reach the "Mains economy sw." menu with button "i" via "DIALOG CENTER" → "OK" → "SPECIAL FUNCTIONS" → "OK".

With the buttons ► ◀ select "off" or "1h...4h".

Switching on with Programme "1" or "AV"

Reach the "Switch on with" menu with button "i" via "DIALOG CENTER" → "OK" → "SPECIAL FUNCTIONS" → "OK".

With the buttons ► ◀ select "Programme" or "AV".

Picture/Sound Options visible or invisible for all Programmes

Reach this menu via "DIALOG CENTER" → "OK" → "SPECIAL FUNCTIONS" → "OK" by pressing button "i".

Megalogic-Info

Reach the "Megalogic-Info" menu via "DIALOG CENTER" → "OK" → "SPECIAL FUNCTIONS" → "OK" by pressing button "i".

With the buttons ► ◀ the Megalogic function can be switched on (With) or off (Without).

AVL (Automatic Volume Limiter)

The indication "Automatic Volume Limiter" appears only if the MSP3410D (IC32300) with AVL function is identified in the set.

Colour Match

Reach the "Colour match" menu via "DIALOG CENTER" → "OK" → "SERVICE" → "OK" pressing button "i".

With the buttons ► ◀ the luma delay is set on a per-programme basis.

The luma delay is to be set additionally for TV sets fitted with a PIP Module.

Picture Format Selection via BLD or WSS Station Ident

The remote control button "⏏" allows to switch the picture format over dependent on the type of screen (4:3/16:9 picture tube).

In "Auto" mode, the picture of 16:9 TV sets is automatically changed to the respective format on every change of the status via the Black Line Detector by means of the Wide Screen Signalling Bit from the transmitter.

Picture Format Selection by Switching Voltage Evaluation

The TV set changes the picture format according to the voltage applied to Pin 8 of the active EURO-AV socket. In AV operating mode, the picture format switching function is active for the AV socket (AV1, AV2, AV3).

Noise Reduction P1...99 or 1...199

Reach the "Noise reduct." menu via "DIALOG CENTER" → "OK" → "SERVICE" → "OK" pressing button "i". With the buttons ► ◀ the noise reduction can be set to "Off", "weak", "Auto" for all of the programmes 1...99 or 1...199.

Decoder P1...99 or 1...199

Call up the "Decoder" menu via "DIALOG CENTER" → "OK" → "SERVICE" → "OK" with button "i". With the buttons ► ◀ it is possible to switch the decoder "Off" or "On" for all programmes.

Picture Sharpness

Call up the "Sharpness" menu via "DIALOG CENTER" → "OK" → "SERVICE" → "OK" with button "i". With the buttons ► ◀ it is possible to adjust the picture sharpness in three steps for all programmes.

Decoder P. for Coded Transmissions

Call up the "Decoder sound P." menu via "DIALOG CENTER" → "OK" → "SERVICE" → "OK" with button "i". With the buttons ► ◀ it is possible to set an analog or digital decoder for scrambled transmissions to internal or external switch-over on a per-programme basis.

IR Data Programmer

Reach the "IR-Dataprogrammer" menu via "DIALOG CENTER" → "OK" → "SERVICE" → "OK" pressing button "i". The IR Dataprogrammer 2 makes it possible to store a maximum of 99 programme positions with the data for channel, TV standard, Peri, 4-place station ident display, finetuning center frequency, and the volume offset "0" using the "OK" button.

Rotation

Reach the "Rotation" menu option via "DIALOG CENTER" → "OK" → "SERVICE" → "OK" pressing button "i". With the buttons ► ◀ it is possible to adjust the display angle of the picture with reference to the screen to zero.

AFC Reference

Tune in to a station in band I with standardized channel raster without finetuning. Reach the "AFC reference" menu via "DIALOG CENTER" → "OK" → "SERVICE" → "OK" → "Only for the retailer" → "OK" → Code Number "8500" pressing button "i". On pressing the "OK" button the automatically determined AFC value is indicated.

Hosiden Socket

Reach the "Hosiden socket" menu via "DIALOG CENTER" → "OK" → "SERVICE" → "OK" → "Only for the retailer" → "OK" → Code Number "8500" pressing button "i". With the buttons ► ◀ select "With" or "Without".

White Balance

Reach the "White balance" menu via "DIALOG CENTER" → "OK" → "SERVICE" → "OK" → "Only for the retailer" → "OK" → Code Number "8500" pressing button "i". The values for "Green" and "Blue" can be adjusted with the ► ◀ buttons.

Cancelling EGP Flash

Call up the menu "Cancel EGP flash" via "DIALOG CENTER" → "OK" → "SERVICE" → "OK" → "Only for the retailer" → "OK" → Code Number "8500" pressing button "i". On pressing the "OK" button, the contents of the EGP Flash will be cancelled.

Protection Circuit

Reach the "Protection circuit" menu via "DIALOG CENTER" → "OK" → "SERVICE" → "OK" → "Only for the retailer" → "OK" → Code Number "8500" pressing button "i".

Switch on with...

The "Switch on with" menu can be reached via "DIALOG CENTER" → "OK" → "SERVICE" → "OK" → "Only for the retailer" → "OK" → Code Number "8500" pressing button "i". With the buttons ► ◀ select "Test pattern" or "TV".

Switching the Blue Screen Background On/Off

Reach the "Blue Screen" menu via "DIALOG CENTER" → "OK" → "SERVICE" → "OK" → "Only for the retailer" → "OK" → Code Number "8500" pressing button "i". With the buttons ► ◀ select "On" or "Off".

Type of Picture Tube

Reach the "Tube type" menu via "DIALOG CENTER" → "OK" → "SERVICE" → "OK" → "Only for the retailer" → "OK" → Code Number "8500" pressing button "i". Set the type of picture tube.

Telepilot (remote control handset)

Reach the "Telepilot" menu via "DIALOG CENTER" → "OK" → "SERVICE" → "OK" → "Only for the retailer" → "OK" → Code Number "8500" pressing button "i". With the buttons ► ◀ select the Telepilot enclosed with the TV set.

Terrestrial Tuner Module

Reach the "Terr. tuner module" menu via "DIALOG CENTER" → "OK" → "SERVICE" → "OK" → "Only for the retailer" → "OK" → Code Number "8500" pressing button "i". With the buttons ► ◀ select the built-in tuner.

Geometry

Reach the "Geometry" menu via "DIALOG CENTER" → "OK" → "SERVICE" → "OK" → "Only for the retailer" → "OK" → Code Number "8500" pressing button "i". Adjust the picture geometry with the geometry test pattern.

Preprogramming the SAT Module

Reach the "SAT preprogramming" menu via "DIALOG CENTER" → "OK" → "SERVICE" → "OK" → "Only for the retailer" → "OK" → Code Number "8500" pressing button "i". Confirm with "OK" button.

Watchdog On/Off

Call up the "Watchdog" menu with button "i" via "DIALOG CENTER" → "OK" → "SERVICE" → "OK" → "Only for the retailer" → "OK" → Code Number "8500".

To switch off the watchdog timer:

- select "off" with the **green** remote control button or
- press and hold the **P+** button and switch on with the mains button or
- press and hold the **P-** button and switch on with the mains button

Sound Settings

Call up the "SOUND SETTINGS" menu with the "blue" button → "OK".

Px Sound Level

Volume offset on a per-programme basis to adjust the different volume levels of the individual transmitting stations.

Balance

Setting the volume level between the left and right channel.

Equaliser

Adjustment menu for 5-band equaliser.

Width of Base

Switchable between "normal" and "Wide". (Not for Dolby Surround and Virtual Dolby)

Sound and Headphone Sound Switch-Over

Different types of sounds can be selected using the ► ◀ buttons dependent on the standard.

Audio Output

Can be set to "Solid" or "Adjustable" using the ►◀ buttons.

Loudspeaker Output

Can be set to "On" or "Off" using the ► ◀ buttons.

Basic Picture Settings

Call up the "PICTURE SETTINGS" menu with the "red" button. Following the user guide it is possible to select the options: "Personal values", "During the day", "In the evening" and "Soft" (red button).

Picture Sharpness

With the "red" button → "OK" call up the "PICTURE SETTINGS" menu and select "Sharpness".

With the ► ◀ buttons it is possible to set the picture sharpness in three steps for each individual programme position.

Perfect Clear

With the "red" button → "OK" call up the "PICTURE SETTINGS" menu and select "Perfect Clear".

With the ► ◀ buttons this function can be switched "On" or "Off".

Comb Filter

With the "red" button → "OK" call up the "PICTURE SETTINGS" menu and select "Comb filter".

With the ► ◀ buttons it is possible to choose between "Off" and "Automatic" on a per-programme basis.

Noise Reduction

With the "red" button → "OK" call up the "PICTURE SETTINGS" menu and select "Noise reduct.".

With the ► ◀ buttons it is possible to select the settings "Off", "Automatic", "Weak" and "High!" ("High!" cannot be stored).

Line Flicker Reduction

With the "red" button → "OK" call up the "PICTURE SETTINGS" menu and select "Line flicker reduct.".

With the ► ◀ buttons it is possible to select the settings "Off", and "Automatic".

Maximum Programme Number (reversing point)

Press button "i" to call up the "TV-PROGRAMME-CHART" menu via "DIALOG CENTER" → "OK" and activate the desired broadcast station with the "green" button.

When entering the channel number "00" on any programme position, programme selection with the buttons ▲ ▼ is limited to the numbers lower than this position.

Forced Settings in Programme Mode

Press button "i" to call up the "TV-PROGRAMME-CHART" menu via "DIALOG CENTER" → "OK" and activate the desired broadcast station with the "blue" button.

For activating the forced operating modes via the station ident, enter a comma in the 4th place from the left of the station identification. The 5th and 6th place contain the actual switching information (see table). The first three places of the station identification can be filled with any characters.

Setting the Analog Values

The last entered analog values are stored automatically after about 10s or when changing to the AV positions or vice versa. When setting the following values below the minimum analog value, the optimum value is initialised when switching the TV on or changing from RF → AV.

Service and Special Functions Chassis 12.5

Start of the Service Mode: Via "i" (Dialog Center) → Service → "OK" → Service Code "8500". Activate menus 1 to 4 via buttons "red", "green", "yellow" and "blue".

End the Service Mode: Press button "TXT".

Change of the Memory IC402

After changing IC402 all settings in the service mode must be done according to the table "Basic Settings" (Service Manual).

Activating the Hotel Mode

The Hotel Mode can be activated via Service Mode (menu 1). Select point of menu "Hotel" with button ▼ or ▲, with button ◀ or ▶ set to "YES". End the Service Mode.

With activated Hotel Mode:

- only the "SLEEP TIMER" can be selected in the "Dialog Center".
- the last volume setting is stored as the maximum level possible (H.VOL in menu 1 of the Service Mode).

Deactivating the Hotel Mode

Press and hold button "i" on the remote control handset while switching the TV set on with the mains switch. Select point of menu "Hotel" in menu 1 of Service Mode via button ▼ or ▲, set with button ◀ or ▶ to "NO".

Cancelling the Parental Lock Continuously

To cancel the parental lock enter the number "7038".

ATS Reset (Automatic Tuning System)

Press the power "ON" button while pressing button "L+" on the Remote Control → Language Selection → Country Selection → "OK".

The ATS system stops at every station of acceptable reception quality (AFC and coincidence) and stores the station data and the respective standard automatically. The system then continues searching.

Pressing the "TXT" button stops the ATS function. If ATS will be stopped before storing anyone station, ATS will start again when switching on the TV again.

Software Version Number

The software version number is shown after ending the service mode.

Service and Special Functions Chassis 12.6

Start of the Service Mode: Via "i" (Dialog Center) → Service → "OK" → Service Code "8500". Activate menus 1 to 5 via buttons "red", "green", "yellow" "blue" and "i".

End the Service Mode: Press button "TXT".

Change of the Memory IC402

After changing IC402 all settings in the service mode must be done according to the table "Basic Settings" (Service Manual).

Activating the Hotel Mode

The Hotel Mode can be activated via Service Mode (menu 1).

Select point of menu "Hotel" with button ▼ or ▲, with button ◀ or ▶ set to "YES". End the Service Mode.

With activated Hotel Mode:

- only the "SLEEP TIMER" can be selected in the "Dialog Center".
- the last volume setting is stored as the maximum level possible (H.VOL in menu 1 of the Service Mode).

Deactivating the Hotel Mode

Press and hold button "i" on the remote control handset while switching the TV set on with the mains switch. Activate menu 1 via buttons "red". Select point of menu "Hotel" in menu 1 of Service Mode via button ▼ or ▲, set with button ◀ or ▶ to "NO".

Cancelling the Parental Lock Continuously

To cancel the parental lock enter the number "7038".

ATS Reset (Automatic Tuning System)

Press the power "ON" button while pressing button "▶" on the Remote Control → Language Selection → Country Selection → "OK".

The ATS system stops at every station of acceptable reception quality (AFC and coincidence) and stores the station data and the respective standard automatically. The system then continues searching.

Pressing the "TXT" button stops the ATS function. If ATS will be stopped before storing anyone station, ATS will start again when switching on the TV again.

Software Version Number

The software version number is shown after ending the service mode.

Presets

Press Button "i" to select "Preset" via the Dialog Center → Service → "OK" → "Factory settings", store with "OK".

Maximum Programme Number (Reversing Point):

The reversing point will be automatically added to the station table (indication 0000) and can be sorted like each other channel station.

Service and Special Functions CUC 7303 / 7305

Storing the Analog Values

The entered analog values are either stored automatically after approx. 8 seconds or when switching to standby mode.

Setting the Optimum Values

Pressing "AUX" → "OK" the television receiver is set to the optimum values stored for brightness, contrast, colour contrast and volume.

ATS Start

Press and hold the "AUX" button for approx. 4s until "ATS" (Auto Tuning System) is indicated and confirm with "OK".

Maximum Programme Number (reversing point)

Press the "i" → "OK" buttons and enter "----" under the frequency band selection option (B) at any programme position on the programme setting menu. Confirm with "OK" and leave the menu. As a result of this, programme selection in programme mode with the "P+" and "P-" buttons is limited to the numbers lower than this position.

Calling up the Service Menu at "Hotel mode on"

Press and hold button "i" on the remote control and switch on with the mains button. With the "P+/P-" button select the "Hotel" mode in the menu and set the indication to "OFF" using the "◀ - or + ▶" button.

Calling up the Service Menu

Press and hold button "i" on the remote control and switch on with the mains button.

AGC Alignment

Select "AGC ALIGN" in the Service Menu. Alignment is possible in range 0...62 with the "◀ - / + ▶" buttons.

OSD Position

Select "OSD" (V or H) in the Service Menu and with the "◀ - / + ▶" buttons position the menu table in the centre of the screen.

Activating the Hotel Mode

Select "Hotel ON" in the Service Menu.

Decoder

Via the Service Menu switch the decoder "ON" or "OFF".

Decoder "ON":

Automatic identification of the switching voltage at Pin 8 of the EURO-AV socket (e.g. descrambler operation with TVs in French version, or external RGB mode for Italy).

Continuous Station Ident Indication

So that the programme name is displayed continuously on the screen press the "i" button. After about 8 seconds the programme is displayed in reduced size.

AUX Overview

The AUX menu is called up by pressing the "AUX" remote control button quickly.

Calling up the Contrast Setting Option

Call up the AUX menu and adjust the contrast with "⊗ - / ⊗ +" button.

Calling up the Sleptimer

Call up the AUX menu and activate the timer with the "TXT" button. Enter the desired stop time with the numbered buttons on the remote control and leave the menu with button "i".

Optimum Values for Analog Functions

Call up the AUX menu and press "OK". The optimum values are now called up.

ATS

Call up the AUX menu and press "AUX" for approximately 4s. Press the "OK" button to start the system.

Tint with NTSC

Call up the AUX menu and adjust with the button "⊗ - / ⊗ +".

Service and Special Functions CUC 7350

Storing the Analog Values

The entered analog values are either stored automatically after approx. 8 seconds or when switching to standby mode.

Setting the Optimum Values

Pressing "OK" → "OK" the television receiver is set to the optimum values stored for brightness, contrast, colour contrast, tint and volume. The balance is set to mid-position, treble and bass are linear.

ATS Start

Press and hold the "PC/AUX" button until "ATS" (Auto Tuning System) is indicated and confirm with "OK".

Maximum Programme Number

Press the "PC/AUX" button and enter the channel number "00" at any programme position via the station channel menu. As a result of this, programme selection with the ▼ ▲ buttons in programme mode is limited to the numbers lower than this position.

Calling up the Service Menu at "Hotel mode on"

Press and hold button "i" on the remote control and switch on with the mains button. With the ▼ ▲ buttons select the Hotel Mode in the menu and set the indication to "OFF" using the ◀ ▶ buttons. During the time the "Hotel mode" is active it is not possible to call up the station channel menu with the "PC/AUX" button.

Switching between 50Hz and 60Hz on HF Mode

On programme mode press the "PC/AUX" button and select the standards selection menu item with ◀ ▶. With the ▼ ▲ buttons switch the indication to "NT" for the NTSC television system (only sets with NTSC).

Switching between 50Hz and 60Hz on AV Mode

On AV mode, press the "PC/AUX" button and with the ▼ ▲ buttons set the indication to "NTSC ON / OFF" (only sets with NTSC).

Decoder Operation

Press and hold the "PC/AUX" button and select "DEC" using the ◀ ▶ buttons. With ▼ ▲ switch the decoder "ON". Confirm with "OK". In this way, the CCVS signal, eg. for descrambler operation, is applied to the AV socket, it passes through the descrambler and is fed back to the AV socket. This option can be employed individually at any programme position.

Calling up the Service Menu

Press and hold button "i" on the remote control and switch on with the mains button.

AGC Alignment

Select "AGC ALIGN" in the Service Menu. Alignment is possible in the range 0...63 with the ◀ ▶ buttons.

AFC Alignment

Select "AFC ALIGN" in the Service Menu. Confirm with ◀ or ▶.

OSD Position

Press and hold button "i" on the remote control and switch on with the mains button. Select "OSD POSITION" in the Service Menu and with the ◀ ▶ buttons position the menu table into the centre of the screen.

Activating the Hotel Mode

Select "Hotel ON" in the Service Menu.

IR-Data Programmer

With this menu and the IR-Data Programmer 2 it is possible to transfer a maximum of 99 programme positions with the data for the channel, TV standard, Peri, 4-place station identification. When storing the data, the mid-position is entered for the channel spacing and the volume.

Call up the IR-Data Programmer via the Service Menu.

Decoder (RGB signal fed in on HF mode)

Four different decoder settings are available for selection with the ◀ ▶ buttons:

DEC-ON P	DEC-OFF P
DEC-ON P.	DEC-OFF P.

Indication of the Status

Pressing the remote control button "i" for a short time calls up the pro-programme indication and makes it possible to enter the menu with "OK".

Calling up the Contrast Setting Option

Pressing the remote control buttons "i" → "OK" calls up the contrast setting option.

Calling up the Timer

To call up the timer press the remote control buttons "i" → "OK" → "i". Enter the desired stop time with the numbered buttons on the remote control.

Calling up the Automatic Frequency Control AFC "ON / OFF"

Press the remote control buttons "i" → "OK" → "i" → "i" until the AFC alignment option is displayed.

Continuous Station Ident Indication

When pressing the "i" button the programme name will be displayed continuously in reduced size after about 8 seconds. To clear this option press "i" twice.

Service Manuals sorted by TV sets

TV Set	Part Number	Kind of Manual	Chassis
ARCANCE 37 P37-2101 MV (VNA)	72010 040 7000 72010 040 7100 72010 040 7500	Service Manual Supplement 1 Supplement 5	CUC 2103
ARCANCE 37 P37-2101 MV (VNM)	72010 040 7000 72010 040 7100	Service Manual Supplement 1	CUC 2103
ARCANCE 37 P37-2101 TR (VNA)	72010 040 7000 72010 040 7100 72010 040 7500	Service Manual Supplement 1 Supplement 5	CUC 2103
ARCANCE 37 P37-2101 TR (VNM)	72010 040 7000 72010 040 7200	Service Manual Supplement 2	CUC 2103
ARCANCE 37 P37-5211	72010 044 7000	Service Manual	
ARCANCE 51 T51-2101 MV (VNA)	72010 040 7000 72010 040 7100 72010 040 7500	Service Manual Supplement 1 Supplement 5	CUC 2103
ARCANCE 51 T51-2101 MV (VNM)	72010 040 7000 72010 040 7100	Service Manual Supplement 1	CUC 2103
ARCANCE 55 FLAT TF55-5211	72010 044 7000	Service Manual	
ARCANCE 55 T55-2101 MV (VNA)	72010 040 7000 72010 040 7100 72010 040 7500	Service Manual Supplement 1 Supplement 5	CUC 2103
ARCANCE 55 T55-2101 MV (VNM)	72010 040 7000 72010 040 7100	Service Manual Supplement 1	CUC 2103
ARCANCE 55 T55-5211	72010 044 7000	Service Manual	
ARCANCE 72 FLAT TF72-5211	72010 044 7000	Service Manual	
ARGANTO 70 FLAT MFW70-530/9 DPL (VNM)	72010 024 9000 72010 024 9400 72010 024 9500	Service Manual Supplement 4 Supplement 5	CUC 1930
ARGANTO 70 MW70-500 IRDT (VNM)	72010 025 9000	Service Manual	CUC 2059 D
ARGANTO 70 MW70-502 IRDT/DOLBY (VNM)	72010 025 9000 72010 025 9200	Service Manual Supplement 2	CUC 2059 D
ARGANTO 70 MW70-505 IRDT/DPL (VNM)	72010 025 9000	Service Manual	CUC 2059 D
ARGANTO 70 MW70-510/8 A DPL (VNM)	72010 024 9000 72010 024 9400 72010 024 9500	Service Manual Supplement 4 Supplement 5	CUC 1930
ARGANTO 70 MW70-510/8 DPL (VNM)	72010 024 9000	Service Manual	CUC 1930
ARGANTO 70 MW70-515 MV/DOLBY (VNA)	72010 030 5000 72010 030 5400 72010 030 5500 72010 030 5600	Service Manual Supplement 4 Supplement 5 Supplement 6	CUC 1934
ARGANTO 70 MW70-515 MV/DOLBY (VNM)	72010 030 5000 72010 030 5200 72010 030 5300	Service Manual Supplement 2 Supplement 3	CUC 1934
ARGANTO 70 MW70-600 IRDT (VNM)	72010 025 9000 72010 025 9100	Service Manual Supplement 1	CUC 2059D
ARGANTO 70 MW70-605 IRDT/DPL (VNM)	72010 025 9000 72010 025 9100	Service Manual Supplement 1	CUC 2059D
ARGANTO 82 FLAT MFW82-530/9 DPL (VNM)	72010 024 9000 72010 024 9400 72010 024 9500	Service Manual Supplement 4 Supplement 5	CUC 1931
ARGANTO 82 FLAT MFW82-539/9 DVD (VNM)	72010 024 9000 72010 024 9500 72010 024 9900	Service Manual Supplement 5 Supplement 9	CUC 1931
ARGANTO 82 MW82-500 IRDT (VNM)	72010 025 9000	Service Manual	CUC 2058 D
ARGANTO 82 MW82-502 IRDT/DOLBY (VNM)	72010 025 9000 72010 025 9200	Service Manual	CUC 2058 D
ARGANTO 82 MW82-505 IRDT/DPL (VNM)	72010 025 9000	Service Manual	CUC 2058 D

Observe also the instructions given in the "Safety" Service Manual, part no. 72010 800 0000!

TV Set	Part Number	Kind of Manual	Chassis
ARGANTO 82 MW82-510/8 A DPL (VNM)	72010 024 9000 72010 024 9400 72010 024 9500	Service Manual Supplement 4 Supplement 5	CUC 1931
ARGANTO 82 MW82-510/8 DPL (VNM)	72010 024 9000	Service Manual	CUC 1931
ARGANTO 82 MW82-515 MV/DOLBY (VNA)	72010 030 5000 72010 030 5400 72010 030 5500 72010 030 5600	Service Manual Supplement 4 Supplement 5 Supplement 6	CUC 1935
ARGANTO 82 MW82-515 MV/DOLBY (VNM)	72010 030 5000 72010 030 5100 72010 030 5200	Service Manual Supplement 1 Supplement 2	CUC 1935
ARGANTO 82 MW82-520/9 PALPLUS	72010 019 9000 72010 019 9100 72010 019 9200 72010 019 9400 72010 019 9500	Service Manual Supplement 1 Supplement 2 Supplement 4 Supplement 5	CUC 1983
ARGANTO 82 MW82-600 IRDT (VNM)	72010 025 9000 72010 025 9100	Service Manual Supplement 1	CUC 2058D
ARGANTO 82 MW82-605 IRDT/DPL (VNM)	72010 025 9000 72010 025 9100	Service Manual Supplement 1	CUC 2058D
ATLANTA FLAT SE 7260 DOLBY (VNM)	72010 030 5000 72010 030 5100 72010 030 5200	Service Manual Supplement 1 Supplement 2	CUC 1838
ATLANTA FLAT SE7260 DOLBY (VNG)	72010 030 5000 72010 030 5400 72010 030 5500 72010 030 5600	Service Manual Supplement 4 Supplement 5 Supplement 6	CUC 1838
ATLANTA FLAT SE7260 DOLBY (VNX)	72010 030 5000 72010 030 5400 72010 030 5500 72010 030 5600	Service Manual Supplement 4 Supplement 5 Supplement 6	CUC 1838
ATLANTA SE7220 IDTV/PIP	72010 021 1000 72010 021 1200 72010 021 1400 72010 021 1600	Service Manual Supplement 2 Supplement 4 Supplement 6	CUC 1830
ATLANTA SE7250 A PIP/DOLBY (VNA)	72010 024 9000 72010 024 9300	Service Manual Supplement 3	CUC 1832
ATLANTA SE7250 A PIP/DOLBY (VNM)	72010 024 9000 72010 024 9300	Service Manual Supplement 3	CUC 1832
ATLANTA SE7250 A PIP/DOLBY (VNX)	72010 024 9000 72010 024 9300 72010 024 9400 72010 024 9700	Service Manual Supplement 3 Supplement 4 Supplement 7	CUC 1832
ATLANTA SE7250 PIP DOLBY (VNM)	72010 024 9000	Service Manual	CUC 1832
ATLANTA SE7250/8 DOLBY (VNG)	72010 024 9000 72010 024 9300 72010 024 9400 72010 024 9700	Service Manual Supplement 3 Supplement 4 Supplement 7	CUC 1832
ATLANTA SE7250/8 DOLBY (VNM)	72010 024 9000	Service Manual	CUC 1832
ATLANTA SE7250/8 DOLBY (VNX)	72010 024 9000 72010 024 9300	Service Manual Supplement 3	CUC 1832
BERLIN SE7027/8 PIP	72010 021 1000 72010 021 1200 72010 021 1400 72010 021 1600	Service Manual Supplement 2 Supplement 4 Supplement 6	CUC 1828
BERLIN SE7050/8 PIP/DOLBY	72010 024 9000 72010 024 9100	Service Manual Supplement 1	CUC 1930

Observe also the instructions given in the "Safety" Service Manual, part no. 72010 800 0000!

TV Set	Part Number	Kind of Manual	Chassis
BOSTEN SE7010 IDTV	72010 021 1000	Service Manual	CUC 1836
	72010 021 1200	Supplement 2	
	72010 021 1300	Supplement 3	
	72010 021 1400	Supplement 4	
	72010 021 1700	Supplement 7	
BOSTON SE7010 IDTV	72010 021 1000	Service Manual	CUC 1836
	72010 021 1200	Supplement 2	
	72010 021 1300	Supplement 3	
	72010 021 1400	Supplement 4	
	72010 021 1700	Supplement 7	
BOSTON SE7010 IDTV	72010 021 1000	Service Manual	CUC 1836
	72010 021 1200	Supplement 2	
	72010 021 1300	Supplement 3	
	72010 021 1400	Supplement 4	
	72010 021 1700	Supplement 7	
BOSTON SE7012 DOLBY (VNA)	72010 030 5000	Service Manual	CUC 1837
	72010 030 5400	Supplement 4	
	72010 030 5500	Supplement 5	
	72010 030 5600	Supplement 6	
BOSTON SE7012 DOLBY (VNM)	72010 030 5000	Service Manual	CUC 1837
	72010 030 5100	Supplement 1	
BOSTON SE7015 DOLBY (VNA)	72010 030 5000	Service Manual	CUC 1837
	72010 030 5400	Supplement 4	
	72010 030 5500	Supplement 5	
BOSTON SE7015 DOLBY (VNM)	72010 030 5000	Service Manual	CUC 1837
	72010 030 5400	Supplement 4	
	72010 030 5500	Supplement 5	
CINARO 82 FLAT MFW82-5210/8 DOLBY (VNM)	72010 030 5000	Service Manual	CUC 1935
	72010 030 5400	Supplement 4	
	72010 030 5500	Supplement 5	
	72010 030 5700	Supplement 7	
CINARO 82 FLAT MFW82-5310/8 DOLBY (VNM)	72010 030 5000	Service Manual	CUC 1935
	72010 030 5400	Supplement 4	
	72010 030 5500	Supplement 5	
	72010 030 5700	Supplement 7	
DAVIO 37 P37-2102 (VNM)	72010 040 7000	Service Manual	CUC 2100
	72010 040 7100	Supplement 1	
DAVIO 37 P37-2102 M(VNM)	72010 040 7000	Service Manual	CUC 2100
	72010 040 7100	Supplement 1	
DAVIO 37 P37-2102/1 (VNM)	72010 040 7000	Service Manual	CUC 2100
	72010 040 7200	Supplement 2	
DAVIO 37 P37-2103 MV (VNM)	72010 040 7000	Service Manual	CUC 2100
	72010 040 7100	Supplement 1	
DAVIO 37 P37-2104 MV (VNM)	72010 040 7000	Service Manual	CUC 2100
	72010 040 7200	Supplement 2	
DAVIO 37 P37-2105 MV (VNM)	72010 040 7000	Service Manual	CUC 2100
	72010 040 7200	Supplement 2	
DAVIO 37 P37-2201	72010 043 3000	Service Manual	12.5
	72010 043 3200	Supplement 2	
DAVIO 37 P37-2201	72010 044 4000	Service Manual	12.6
DAVIO 37 P37-2201 FR	72010 044 2000	Service Manual	12.5
DAVIO 37 P37-2201 FR	72010 044 6000	Service Manual	12.6
DAVIO 37 P37-3201 FR	72010 044 6000	Service Manual	12.6
DAVIO 37 P37-4101 GB (VNA)	72010 040 7000	Service Manual	CUC 2103 GB
	72010 040 7100	Supplement 1	
	72010 040 7500	Supplement 5	
DAVIO 37 P37-4101 GB (VNM)	72010 040 7000	Service Manual	CUC 2103 GB
	72010 040 7100	Supplement 1	

Observe also the instructions given in the "Safety" Service Manual, part no. 72010 800 0000!

TV Set	Part Number	Kind of Manual	Chassis
DAVIO 37 P37-4101 MV (VNA)	72010 040 7000 72010 040 7300	Service Manual Supplement 3	CUC 2103
DAVIO 37 P37-4101 MV (VNA)	72010 040 7000 72010 040 7100 72010 040 7500	Service Manual Supplement 1 Supplement 5	CUC 2103
DAVIO 37 P37-4101 MV (VNM)	72010 040 7000 72010 040 7100	Service Manual Supplement 1	CUC 2103
DAVIO 37 P37-4101 MV (VNX)	72010 040 7000 72010 040 7400	Service Manual Supplement 4	CUC 2103
DAVIO 37 P37-4101 TOP (VNA)	72010 040 7000 72010 040 7100 72010 040 7500	Service Manual Supplement 1 Supplement 5	CUC 2103
DAVIO 37 P37-4101 TOP (VNM)	72010 040 7000 72010 040 7100	Service Manual Supplement 1	CUC 2103
DAVIO 37 P37-4101 TOP (VNX)	72010 040 7000 72010 040 7400	Service Manual Supplement 4	CUC 2103
DAVIO 37 P37-4101 TOP/1 (VNA)	72010 040 7000 72010 040 7100 72010 040 7500	Service Manual Supplement 1 Supplement 5	CUC 2103
DAVIO 37 P37-4101 TOP/1 (VNM)	72010 040 7000 72010 040 7100	Service Manual Supplement 1	CUC 2103
DAVIO 37 P37-4101 TOP/1 (VNX)	72010 040 7000 72010 040 7400	Service Manual Supplement 4	CUC 2103
DAVIO 37 P37-4101 TOP/TR (VNA)	72010 040 7000 72010 040 7100 72010 040 7500	Service Manual Supplement 1 Supplement 5	CUC 2103
DAVIO 37 P37-4101 TOP/TR (VNM)	72010 040 7000 72010 040 7100	Service Manual Supplement 1	CUC 2103
DAVIO 37 P37-4101/12 MV (VNA)	72010 040 7000 72010 040 7400	Service Manual Supplement 4	CUC 2105
DAVIO 37 P37-4101/12 MV (VNM)	72010 040 7000 72010 040 7300	Service Manual Supplement 3	CUC 2105
DAVIO 37 P37-4101/12 MV SAT (VNM)	72010 040 7000 72010 040 7300	Service Manual Supplement 3	CUC 2105
DAVIO 37 P37-4101/12 MV/SAT (VNA)	72010 040 7000 72010 040 7400	Service Manual Supplement 4	CUC 2105
DAVIO 37 P37-4201 TOP	72010 043 3000 72010 043 3200	Service Manual Supplement 2	12.5
DAVIO 37 P37-4201 TOP	72010 044 4000	Service Manual	12.6
DAVIO 37 P37-4201/5 TOP	72010 043 3000 72010 043 3200	Service Manual Supplement 2	12.5
DAVIO 37 P37-4201/5 TOP	72010 044 4000	Service Manual	12.6
DAVIO 51 T51-3101 MV (VNA)	72010 040 7000 72010 040 7100 72010 040 7500	Service Manual Supplement 1 Supplement 5	CUC 2103
DAVIO 51 T51-3101 MV (VNM)	72010 040 7000 72010 040 7100	Service Manual Supplement 1	CUC 2103
DAVIO 51 T51-3101 TOP (VNA)	72010 040 7000 72010 040 7100 72010 040 7500	Service Manual Supplement 1 Supplement 5	CUC 2103
DAVIO 51 T51-3101 TOP (VNM)	72010 040 7000	Service Manual	CUC 2103
DAVIO 51 T51-3101 TOP/1 (VNA)	72010 040 7000 72010 040 7100 72010 040 7500	Service Manual Supplement 1 Supplement 5	CUC 2103
DAVIO 51 T51-3101 TOP/1 (VNM)	72010 040 7000 72010 040 7100	Service Manual Supplement 1	CUC 2103

Observe also the instructions given in the "Safety" Service Manual, part no. 72010 800 0000!

TV Set	Part Number	Kind of Manual	Chassis
DAVIO 51 T51-3101 TOP/TR (VNA)	72010 040 7000 72010 040 7100 72010 040 7500	Service Manual Supplement 1 Supplement 5	CUC 2103
DAVIO 51 T51-3101 TOP/TR (VNM)	72010 040 7000 72010 040 7100	Service Manual Supplement 1	CUC 2103
DAVIO 51 T51-4201 TOP	72010 043 3000 72010 043 3200	Service Manual Supplement 2	12.5
DAVIO 51 T51-4201 TOP	72010 044 4000	Service Manual	12.6
DAVIO 51 T51-4201/5 TOP	72010 043 3000 72010 043 3200	Service Manual Supplement 2	12.5
DAVIO 51 T51-4201/5 TOP	72010 044 4000	Service Manual	12.6
DAVIO 55 M55-290/8 IDTV	72010 021 1000 72010 021 1200 72010 021 1400 72010 021 1900	Service Manual Supplement 2 Supplement 4 Supplement 9	CUC 1806
DAVIO 55 ST55-852 Dolby (VNM)	72010 024 7000 72010 024 7300	Service Manual Supplement 3	CUC 2021
DAVIO 55 ST55-854 DOLBY (VNA)	72010 040 7000 72010 040 7400	Service Manual Supplement 4	CUC 2121
DAVIO 55 ST55-854 DOLBY (VNM)	72010 040 7000	Service Manual	CUC 2121
DAVIO 55 ST55-854/8 DOLBY (VNA)	72010 040 7000 72010 040 7300	Service Manual Supplement 3	CUC 2121 M
DAVIO 55 ST55-854/8 DOLBY (VNA)	72010 040 7000 72010 040 7400	Service Manual Supplement 4	CUC 2121M
DAVIO 55 ST55-854/8 DOLBY (VNM)	72010 040 7000	Service Manual	CUC 2121 M
DAVIO 55 ST55-854/8 DOLBY (VNX)	72010 040 7000 72010 040 7400	Service Manual Supplement 4	CUC 2121M
DAVIO 55 ST55-855 NIC/TOP (VNM)	72010 024 7000 72010 024 7200	Service Manual Supplement 2	CUC 2021 N
DAVIO 55 ST55-870 FR/TOP (VNM)	72010 027 2000	Service Manual	CUC 2021F
DAVIO 55 ST55-880 FR/DOLBY (VNM)	72010 027 2000 72010 027 2100	Service Manual Supplement 1	CUC 2021 F
DAVIO 55 ST55.852 Dolby (VNM)	72010 024 7000 72010 024 7300	Service Manual Supplement 3	CUC 2021N
DAVIO 55 T55-4101 GB (VNA)	72010 040 7000 72010 040 7100 72010 040 7500	Service Manual Supplement 1 Supplement 5	CUC 2103 GB
DAVIO 55 T55-4101 GB (VNM)	72010 040 7000 72010 040 7100	Service Manual Supplement 1	CUC 2103
DAVIO 55 T55-4101 MV (VNA)	72010 040 7000 72010 040 7100 72010 040 7500	Service Manual Supplement 1 Supplement 5	CUC 2103 M
DAVIO 55 T55-4101 MV (VNM)	72010 040 7000	Service Manual	CUC 2103 M
DAVIO 55 T55-4101 SAT (VNM)	72010 040 7000 72010 040 7200	Service Manual Supplement 2	CUC 2103
DAVIO 55 T55-4101 TOP (VNA)	72010 040 7000 72010 040 7100 72010 040 7500	Service Manual Supplement 1 Supplement 5	CUC 2103
DAVIO 55 T55-4101 TOP (VNM)	72010 040 7000 72010 040 7100	Service Manual Supplement 1	CUC 2103
DAVIO 55 T55-4101 TOP/1 (VNA)	72010 040 7000 72010 040 7100 72010 040 7500	Service Manual Supplement 1 Supplement 5	CUC 2103
DAVIO 55 T55-4101 TOP/1 (VNM)	72010 040 7000 72010 040 7100	Service Manual Supplement 1	CUC 2103

Observe also the instructions given in the "Safety" Service Manual, part no. 72010 800 0000!

TV Set	Part Number	Kind of Manual	Chassis
DAVIO 55 T55-4101 TOP/TR (VNA)	72010 040 7000 72010 040 7100 72010 040 7500	Service Manual Supplement 1 Supplement 5	CUC 2103
DAVIO 55 T55-4101 TOP/TR (VNM)	72010 040 7000 72010 040 7100	Service Manual Supplement 1	CUC 2103
DAVIO 55 T55-4201 FR/TOP	72010 044 2000	Service Manual	12.5
DAVIO 55 T55-4201 FR/TOP	72010 044 6000	Service Manual	12.6
DAVIO 55 T55-4201 TOP	72010 043 3000 72010 043 3200	Service Manual Supplement 2	12.5
DAVIO 55 T55-4201 TOP	72010 044 4000	Service Manual	12.6
DAVIO 55 T55-4201/5 TOP	72010 043 3000 72010 043 3200	Service Manual Supplement 2	12.5
DAVIO 55 T55-4201/5 TOP	72010 044 4000	Service Manual	12.6
DAVIO 70 M70-290 IDTV (VNM)	72010 021 1000 72010 021 1200 72010 021 1400 72010 021 1900	Service Manual Supplement 2 Supplement 4 Supplement 9	CUC 1836
DAVIO 70 M70-290/8 IDTV (VNM)	72010 021 1000 72010 021 1200 72010 021 1400 72010 021 1900	Service Manual Supplement 2 Supplement 4 Supplement 9	CUC 1836
DAVIO 70 ST70-2210 DOLBY (VNM)	72010 030 5000 72010 030 5400 72010 030 5500	Service Manual Supplement 4 Supplement 5	CUC 1837
DAVIO 70 ST70-292 DOLBY (VNA)	72010 030 5000 72010 030 5400 72010 030 5500 72010 030 5600	Service Manual Supplement 4 Supplement 5 Supplement 6	CUC 1837
DAVIO 70 ST70-292 DOLBY (VNM)	72010 030 5000 72010 030 5100	Service Manual Supplement 1	CUC 1837
DAVIO 70 ST70-292 DOLBY (VNX)	72010 030 5000 72010 030 5400 72010 030 5500 72010 030 5600	Service Manual Supplement 4 Supplement 5 Supplement 6	CUC 1837
DAVIO 70 ST70-292/8 DOLBY (VNA)	72010 030 5000 72010 030 5400 72010 030 5500 72010 030 5600	Service Manual Supplement 4 Supplement 5 Supplement 6	CUC 1837
DAVIO 70 ST70-292/8 DOLBY (VNM)	72010 030 5000 72010 030 5100	Service Manual Supplement 1	CUC 1837
DAVIO 70 ST70-292/8 DOLBY (VNX)	72010 030 5000 72010 030 5400 72010 030 5500 72010 030 5600	Service Manual Supplement 4 Supplement 5 Supplement 6	CUC 1837
DAVIO 70 ST70-5001 DOLBY (VNM)	72010 024 8000 72010 024 8400	Service Manual Supplement 4	CUC 2032
DAVIO 70 ST70-5001 NIC/DOLBY (VNM)	72010 026 0000 72010 026 0300 72010 026 0400	Service Manual Supplement 3 Supplement 4	CUC 2030 N
DAVIO 70 ST70-5101 DOLBY (VNA)	72010 041 6000 72010 041 6200	Service Manual Supplement 2	CUC 2130
DAVIO 70 ST70-5101 DOLBY (VNM)	72010 041 6000 72010 041 6200	Service Manual Supplement 2	CUC 2130
DAVIO 70 ST70-5101/8 DOLBY (VNA)	72010 041 6000 72010 041 6200	Service Manual Supplement 2	CUC 2130M
DAVIO 70 ST70-5101/8 DOLBY (VNM)	72010 041 6000 72010 041 6200	Service Manual Supplement 2	CUC 2130M

Observe also the instructions given in the "Safety" Service Manual, part no. 72010 800 0000!

TV Set	Part Number	Kind of Manual	Chassis
DAVIO 70 ST70-5210/8 DOLBY (VNA)	72010 030 5000 72010 030 5400 72010 030 5500	Service Manual Supplement 4 Supplement 5	CUC 1837
DAVIO 70 ST70-5210/8 DOLBY (VNM)	72010 030 5000 72010 030 5400 72010 030 5500	Service Manual Supplement 4 Supplement 5	CUC 1837
DAVIO 70 ST70-8510 NIC/DOLBY (VNM)	72010 026 0000 72010 026 0300	Service Manual Supplement 3	CUC 2030 N
DAVIO 70 ST70-853 NIC/PIP (VNM)	72010 026 0000	Service Manual	CUC 2050N
DAVIO 70 ST70-853 NIC/PIP (VNM)	72010 026 0000	Service Manual	CUC 2050 N
DAVIO 70 ST70-870 FR/TOP (VNM)	72010 020 8000 72010 020 8200 72010 020 8300 72010 020 8500	Service Manual Supplement 2 Supplement 3 Supplement 5	CUC 2035 F
DAVIO 70 ST70-880 FR/Dolby (VNM)	72010 028 6000	Service Manual	CUC 2035F
DAVIO 70 ST79-854 PIP/Dolby (VNM)	72010 026 0000 72010 026 0200	Service Manual Supplement 2	CUC 2050N
DENVER FLAT SE8260/8 DOLBY (VNA)	72010 030 5000 72010 030 5400 72010 030 5500 72010 030 5600	Service Manual Supplement 4 Supplement 5 Supplement 6	CUC 1935
DENVER FLAT SE8260/8 DOLBY (VNG)	72010 030 5000 72010 030 5400 72010 030 5500 72010 030 5600	Service Manual Supplement 4 Supplement 5 Supplement 6	CUC 1935
DENVER FLAT SE8260/8 DOLBY (VNM)	72010 030 5000 72010 030 5200 72010 030 5300	Service Manual Supplement 2 Supplement 3	CUC 1935
DENVER FLAT SE8260/8 DOLBY (VNX)	72010 030 5000 72010 030 5400 72010 030 5500 72010 030 5600	Service Manual Supplement 4 Supplement 5 Supplement 6	CUC 1935
DENVER SE82-100 PALPLUS	72010 019 9000 72010 019 9100 72010 019 9200 72010 019 9400	Service Manual Supplement 1 Supplement 2 Supplement 4	CUC 1984
DENVER SE8227/8 PIP	72010 021 1000 72010 021 1200 72010 021 1300 72010 021 1400 72010 021 1700	Service Manual Supplement 2 Supplement 3 Supplement 4 Supplement 7	CUC 1929
DENVER SE8227/8 PIP	72010 021 1000 72010 021 1200 72010 021 1300 72010 021 1400 72010 021 1700	Service Manual Supplement 2 Supplement 3 Supplement 4 Supplement 7	CUC 1929
DENVER SE8250/8 PIP/DOLBY (VNG)	72010 024 9000 72010 024 9300 72010 024 9400 72010 024 9700	Service Manual Supplement 3 Supplement 4 Supplement 7	CUC 1931
DENVER SE8250/8 PIP/DOLBY (VNM)	72010 024 9000 72010 024 9100	Service Manual Supplement 1	CUC 1931
DENVER SE8250/8 PIP/DOLBY (VNX)	72010 024 9000 72010 024 9300	Service Manual Supplement 3	CUC 1931
ELEGANCE 63 ST63-2103 DOLBY (VNA)	72010 041 6000 72010 041 6200	Service Manual Supplement 2	CUC 2130
ELEGANCE 63 ST63-2103 DOLBY (VNM)	72010 041 6000	Service Manual	CUC 2130
ELEGANCE 63 ST63-2103/8 DOLBY (VNA)	72010 041 6000 72010 041 6200	Service Manual Supplement 2	CUC 2130M

Observe also the instructions given in the "Safety" Service Manual, part no. 72010 800 0000!

TV Set	Part Number	Kind of Manual	Chassis
ELEGANCE 63 ST63-2103/8 DOLBY (VNM)	72010 041 6000	Service Manual	CUC 2130 M
ELEGANCE 63 ST63-300 DOLBY (VNA)	72010 030 5000	Service Manual	CUC 1837
	72010 030 5400	Supplement 4	
	72010 030 5500	Supplement 5	
	72010 030 5600	Supplement 6	
ELEGANCE 63 ST63-300 DOLBY (VNM)	72010 030 5000	Service Manual	CUC 1837
	72010 030 5200	Supplement 2	
	72010 030 5300	Supplement 3	
ELEGANCE 63 ST63-300 DOLBY (VNX)	72010 030 5000	Service Manual	CUC 1837
	72010 030 5400	Supplement 4	
	72010 030 5500	Supplement 5	
	72010 030 5600	Supplement 6	
ELEGANCE 63 ST63-300/8 DOLBY (VNA)	72010 030 5000	Service Manual	CUC 1837
	72010 030 5400	Supplement 4	
	72010 030 5500	Supplement 5	
	72010 030 5600	Supplement 6	
ELEGANCE 63 ST63-300/8 DOLBY (VNM)	72010 030 5000	Service Manual	CUC 1837
	72010 030 5200	Supplement 2	
	72010 030 5300	Supplement 3	
ELEGANCE 63 ST63-300/8 DOLBY (VNX)	72010 030 5000	Service Manual	CUC 1837
	72010 030 5400	Supplement 4	
	72010 030 5500	Supplement 5	
	72010 030 5600	Supplement 6	
ELEGANCE 63 ST63-305/8 DOLBY (VNA)	72010 030 5000	Service Manual	CUC 1837
	72010 030 5400	Supplement 4	
	72010 030 5500	Supplement 5	
ELEGANCE 63 ST63-305/8 DOLBY (VNM)	72010 030 5000	Service Manual	CUC 1837
	72010 030 5400	Supplement 4	
	72010 030 5500	Supplement 5	
ELEGANCE 70 FLAT MFW70-3201 NIC/DOLBY (VNM)	72010 043 1000 72010 043 1100	Service Manual Supplement 1	CUC 2069 N
ELEGANCE 70 FLAT MFW70-3210/8 DOLBY (VNM)	72010 030 5000	Service Manual	CUC 1934
	72010 030 5400	Supplement 4	
	72010 030 5500	Supplement 5	
ELEGANCE 70 M70-300 DOLBY (VNM)	72010 030 5000	Service Manual	CUC 1837
ELEGANCE 70 M70-3110 DOLBY (VNA)	72010 030 5000	Service Manual	CUC 1837
	72010 030 5400	Supplement 4	
	72010 030 5500	Supplement 5	
	72010 030 5600	Supplement 6	
ELEGANCE 70 M70-3110 DOLBY (VNM)	72010 030 5000	Service Manual	CUC 1837
	72010 030 5200	Supplement 2	
	72010 030 5300	Supplement 3	
ELEGANCE 70 M70-3110 DOLBY (VNX)	72010 030 5000	Service Manual	CUC 1837
	72010 030 5400	Supplement 4	
	72010 030 5500	Supplement 5	
	72010 030 5600	Supplement 6	
ELEGANCE 70 MW70-150/8 DOLBY (VNA)	72010 030 5000	Service Manual	CUC 1934
	72010 030 5400	Supplement 4	
	72010 030 5500	Supplement 5	
	72010 030 5600	Supplement 6	
ELEGANCE 70 MW70-150/8 DOLBY (VNM)	72010 030 5000	Service Manual	CUC 1934
ELEGANCE 70 MW70-2101 DOLBY (VNM)	72010 026 0000	Service Manual	CUC 2059
	72010 026 0300	Supplement 3	
	72010 026 0400	Supplement 4	
ELEGANCE 70 MW70-2101 NIC/DOLBY (VNM)	72010 026 0000	Service Manual	CUC 2059 N
	72010 026 0300	Supplement 3	
	72010 026 0400	Supplement 4	
ELEGANCE 70 MW70-2201 NIC/DOLBY (VNM)	72010 043 1000 72010 043 1100	Service Manual Supplement 1	CUC 2069 N

Observe also the instructions given in the "Safety" Service Manual, part no. 72010 800 0000!

TV Set	Part Number	Kind of Manual	Chassis
ELEGANCE 70 ST 70-2103/8 DOLBY (VNM)	72010 041 6000	Service Manual	CUC 2130 M
ELEGANCE 70 ST70-2102 NIC/DOLBY (VNM)	72010 026 0000 72010 026 0300 72010 026 0400	Service Manual Supplement 3 Supplement 4	CUC 2030 N
ELEGANCE 70 ST70-2103 DOLBY (VNA)	72010 041 6000 72010 041 6200	Service Manual Supplement 2	CUC 2130
ELEGANCE 70 ST70-2103 DOLBY (VNM)	72010 041 6000	Service Manual	CUC 2130
ELEGANCE 70 ST70-2103/8 DOLBY (VNA)	72010 041 6000 72010 041 6200	Service Manual Supplement 2	CUC 2130M
ELEGANCE 70 ST70-2206 FR/DOLBY (VNM/ VNA)	72010 044 1000	Service Manual	CUC 2060 F
ELEGANCE 70 ST70-300 DOLBY (VNA)	72010 030 5000 72010 030 5400 72010 030 5500 72010 030 5600	Service Manual Supplement 4 Supplement 5 Supplement 6	CUC 1837
ELEGANCE 70 ST70-300 DOLBY (VNG)	72010 030 5000 72010 030 5400 72010 030 5500 72010 030 5600	Service Manual Supplement 4 Supplement 5 Supplement 6	CUC 1837
ELEGANCE 70 ST70-300 DOLBY (VNM)	72010 030 5000	Service Manual	CUC 1837
ELEGANCE 70 ST70-300 DOLBY (VNN)	72010 045 1000	Service Manual	CUC 1837 A
ELEGANCE 70 ST70-300 DOLBY (VNR)	72010 030 5000 72010 030 5400 72010 030 5500 72010 030 5600	Service Manual Supplement 4 Supplement 5 Supplement 6	CUC 1837
ELEGANCE 70 ST70-300 DOLBY (VNU)	72010 030 5000 72010 030 5400 72010 030 5500 72010 030 5600	Service Manual Supplement 4 Supplement 5 Supplement 6	CUC 1837
ELEGANCE 70 ST70-300 DOLBY (VNX)	72010 030 5000 72010 030 5400 72010 030 5500 72010 030 5600	Service Manual Supplement 4 Supplement 5 Supplement 6	CUC 1837
ELEGANCE 70 ST70-300/8 DOLBY (VNM)	72010 030 5000	Service Manual	CUC 1837
ELEGANCE 70 ST70-300/8 DOLBY (VNR)	72010 030 5000 72010 030 5400 72010 030 5500 72010 030 5600	Service Manual Supplement 4 Supplement 5 Supplement 6	CUC 1837
ELEGANCE 70 ST70-300/8 DOLBY (VNX)	72010 030 5000 72010 030 5400 72010 030 5500 72010 030 5600	Service Manual Supplement 4 Supplement 5 Supplement 6	CUC 1837
ELEGANCE 70 ST70-305/8 DOLBY (VNM,VNA)	72010 030 5000 72010 030 5400 72010 030 5500	Service Manual Supplement 4 Supplement 5	CUC 1837
ELEGANCE 70 ST70-305/8 DOLBY (VNX,VNG)	72010 030 5000 72010 030 5400 72010 030 5500	Service Manual Supplement 4 Supplement 5	CUC 1837
ELEGANCE 70 ST70-900 DOLBY (VNM)	72010 024 8000 72010 024 8300	Service Manual Supplement 3	CUC 2032
ELEGANCE 70 ST70-900 DOLBY/TR (VNM)	72010 024 8000 72010 024 8400	Service Manual Supplement 4	CUC 2032
ELEGANCE 70 ST70-900 FR/DOLBY (VNM)	72010 028 6000 72010 028 6100	Service Manual Supplement 1	CUC 2035 F
ELEGANCE 70 ST70-900 NIC/DOLBY(VNM)	72010 026 0000 72010 026 0300 72010 026 0400	Service Manual Supplement 3 Supplement 4	CUC 2030 N

Observe also the instructions given in the "Safety" Service Manual, part no. 72010 800 0000!

TV Set	Part Number	Kind of Manual	Chassis
ELEGANCE 70 ST70-900/4 DOLBY (VNM)	72010 026 0000 72010 026 0300 72010 026 0400	Service Manual Supplement 3 Supplement 4	CUC 2030 N
ELEGANCE 70 ST70-904 NIC/DOLBY (VNM)	72010 026 0000 72010 026 0300 72010 026 0400	Service Manual Supplement 3 Supplement 4	CUC 2030 N
ELEGANCE 72 FLAT MF72-3101/8 DOLBY (VNA)	72010 041 6000 72010 041 6200	Service Manual Supplement 2	CUC 2131M
ELEGANCE 72 FLAT MF72-3101/8 DOLBY (VNM)	72010 041 6000 72010 041 6200	Service Manual Supplement 2	CUC 2131M
ELEGANCE 72 FLAT MF72-3110 DOLBY (VNA)	72010 030 5000 72010 030 5400 72010 030 5500 72010 030 5600	Service Manual Supplement 4 Supplement 5 Supplement 6	CUC 1838
ELEGANCE 72 FLAT MF72-3110 DOLBY (VNM)	72010 030 5000 72010 030 5400	Service Manual Supplement 4	CUC 1838
ELEGANCE 72 FLAT MF72-3110 DOLBY (VNX)	72010 030 5000 72010 030 5400 72010 030 5500 72010 030 5600	Service Manual Supplement 4 Supplement 5 Supplement 6	CUC 1838
ELEGANCE 72 FLAT MF72-3110/8 DOLBY (VNA)	72010 030 5000 72010 030 5400 72010 030 5500 72010 030 5600	Service Manual Supplement 4 Supplement 5 Supplement 6	CUC 1838
ELEGANCE 72 FLAT MF72-3110/8 DOLBY (VNM)	72010 030 5000 72010 030 5400	Service Manual Supplement 4	CUC 1838
ELEGANCE 72 FLAT MF72-3110/8 DOLBY (VNX)	72010 030 5000 72010 030 5400 72010 030 5500 72010 030 5600	Service Manual Supplement 4 Supplement 5 Supplement 6	CUC 1838
ELEGANCE 72 FLAT MF72-3115/8 DOLBY (VNA)	72010 030 5000 72010 030 5400 72010 030 5500	Service Manual Supplement 4 Supplement 5	CUC 1838
ELEGANCE 72 FLAT MF72-3115/8 DOLBY (VNM)	72010 030 5000 72010 030 5400 72010 030 5500	Service Manual Supplement 4 Supplement 5	CUC 1838
ELEGANCE 82 FLAT MFW82-3101 NIC/DOLBY (VNM)	72010 043 1000	Service Manual	CUC 2068N
ELEGANCE 82 FLAT MFW82-3110 MV/DOLBY (VNA)	72010 030 5000 72010 030 5400 72010 030 5500 72010 030 5600	Service Manual Supplement 4 Supplement 5 Supplement 6	CUC 1935
ELEGANCE 82 FLAT MFW82-3110 MV/DOLBY (VNG)	72010 030 5000 72010 030 5400 72010 030 5500 72010 030 5600	Service Manual Supplement 4 Supplement 5 Supplement 6	CUC 1935
ELEGANCE 82 FLAT MFW82-3110 MV/DOLBY (VNM)	72010 030 5000	Service Manual	CUC 1935
ELEGANCE 82 FLAT MFW82-3110 MV/DOLBY (VNR,VNU)	72010 045 1000	Service Manual	CUC 1935 A
ELEGANCE 82 FLAT MFW82-3110 MV/DOLBY (VNX)	72010 030 5000 72010 030 5400 72010 030 5500 72010 030 5600	Service Manual Supplement 4 Supplement 5 Supplement 6	CUC 1935
ELEGANCE 82 MW82-150/8 DOLBY (VNA)	72010 030 5000 72010 030 5400 72010 030 5500 72010 030 5600	Service Manual Supplement 4 Supplement 5 Supplement 6	CUC 1935
ELEGANCE 82 MW82-150/8 DOLBY (VNM)	72010 030 5000	Service Manual	CUC 1935

Observe also the instructions given in the "Safety" Service Manual, part no. 72010 800 0000!

TV Set	Part Number	Kind of Manual	Chassis
ELEGANCE 82 MW82-2101 DOLBY (VNM)	72010 026 0000 72010 026 0300 72010 026 0400	Service Manual Supplement 3 Supplement 4	CUC 2058
ELEGANCE 82 MW82-2101 NIC/DOLBY (VNM)	72010 026 0000 72010 026 0300 72010 026 0400	Service Manual Supplement 3 Supplement 4	CUC 2058 N
ELEGANCE 82 MW82-2201 NIC/DOLBY (VNM)	72010 043 1000	Service Manual	CUC 2068N
FINE ARTS PLANAVISION PW 110-8110/9 DOLBY	Home Service		
FINE ARTS PLANAVISION PW 110-8110/9 DOLBY	Home Service		
FINE ARTS PLANAVISION PW110-8110/9 DOLBY (VNM)	72010 024 6000 72010 024 6100	Service Manual Supplement 1	
FINE ARTS VISION MFW82-710/9 DPL/PIP (VNM)	72010 024 9000 72010 024 9100 72010 024 9200	Service Manual Supplement 1 Supplement 2	CUC 1931
FINE ARTS VISION MFW82-720/9 DVD (VNM)	72010 024 9000 72010 024 9100 72010 024 9200	Service Manual Supplement 1 Supplement 2	CUC 1931
FINE ARTS VISION MFW82-710/8 DVD (VNM)	72010 024 9000 72010 024 9200 72010 024 9400 72010 024 9800	Service Manual Supplement 2 Supplement 4 Supplement 8	CUC 1931
FINE ARTS VISION MFW82-710/9 DVD (VNA)	72010 024 9000 72010 024 9200 72010 024 9900 72010 041 9100 72010 027 9000 72010 027 9200	Service Manual Supplement 2 Supplement 9 Supplement 10 SM DVD Supp. 1 DVD	CUC 1931
FINE ARTS VISION MFW82-710/9 DVD (VNX)	72010 024 9000 72010 024 9200 72010 024 9900 72010 041 9100 72010 027 9000 72010 027 9200	Service Manual Supplement 2 Supplement 9 Supplement 10 SM DVD Supp. 1 DVD	CUC 1931
GREENVILLE 100 SE7030 (VNM)	72010 021 1000 72010 021 1200 72010 021 1400 72010 021 1900	Service Manual Supplement 2 Supplement 4 Supplement 9	CUC 1836
GREENVILLE 370 SE3781 TOP	72010 024 0000	Service Manual	CUC 2003
GREENVILLE 370 SE3781 TOP	72010 024 0000 72010 024 0100	Service Manual Supplement 1	CUC 2003
GREENVILLE 550 SE5586 TOP	72010 021 4000	Service Manual	CUC 2020
GREENVILLE 560 SE5587 TOP	72010 024 7000	Service Manual	CUC 2021
GREENVILLE 561 SE5590 Dolby (VNM)	72010 024 7000 72010 024 7300	Service Manual Supplement 3	CUC 2021
GREENVILLE 7004 NIC/TOP	72010 020 7000 72010 020 7100 72010 020 7300 72010 020 7400	Service Manual Supplement 1 Supplement 3 Supplement 4	CUC 2050 N
GREENVILLE 7005 TOP (VNM)	72010 024 8000	Service Manual	CUC 2032
GREENVILLE 7006 DOLBY (VNM)	72010 024 8000 72010 024 8200	Service Manual Supplement 2	CUC 2032
GREENVILLE 7006 NIC/DOLBY (VNM)	72010 026 0300 72010 026 0000	Service Manual Supplement 3	CUC 2030 N
GREENVILLE 7007 DOLBY (VNA)	72010 041 6000 72010 041 6200	Service Manual Supplement 2	CUC 2130
GREENVILLE 7007 DOLBY (VNM)	72010 041 6000 72010 041 6200	Service Manual Supplement 2	CUC 2130

Observe also the instructions given in the "Safety" Service Manual, part no. 72010 800 0000!

TV Set	Part Number	Kind of Manual	Chassis
GREENVILLE 7007/8 DOLBY (VNA)	72010 041 6000 72010 041 6200	Service Manual Supplement 2	CUC 2130M
GREENVILLE 7007/8 DOLBY (VNM)	72010 041 6000 72010 041 6200	Service Manual Supplement 2	CUC 2130M
GREENVILLE SE5592 DOLBY (VNA)	72010 040 7000 72010 040 7400	Service Manual Supplement 4	CUC 2121
GREENVILLE SE5592 DOLBY (VNM)	72010 040 7000 72010 040 7400	Service Manual Supplement 4	CUC 2121
GREENVILLE SE5592 MV/DOLBY (VNA)	72010 040 7000 72010 040 7200 72010 040 7500	Service Manual Supplement 2 Supplement 5	CUC 2121 M
GREENVILLE SE5592 MV/DOLBY (VNG)	72010 040 7000 72010 040 7400	Service Manual Supplement 4	CUC 2121M
GREENVILLE SE5592 MV/DOLBY (VNM)	72010 040 7000 72010 040 7200	Service Manual Supplement 2	CUC 2121 M
GREENVILLE SE5592 MV/DOLBY (VNX)	72010 040 7000 72010 040 7400	Service Manual Supplement 4	CUC 2121M
HAMBURG SE8240 DOLBY (VNA)	72010 030 5000 72010 030 5400 72010 030 5500 72010 030 5600	Service Manual Supplement 4 Supplement 5 Supplement 6	CUC 1935
HAMBURG SE8240 DOLBY (VNM)	72010 030 5000	Service Manual	CUC 1935
LEEMAX 72 FLAT MF72-9110/8 DOLBY (VNA)	72010 030 5000 72010 030 5400 72010 030 5500 72010 030 5600	Service Manual Supplement 4 Supplement 5 Supplement 6	CUC 1838
LEEMAX 72 FLAT MF72-9110/8 DOLBY (VNX)	72010 030 5000 72010 030 5400 72010 030 5500 72010 030 5600	Service Manual Supplement 4 Supplement 5 Supplement 6	CUC 1838
LEEMAXX 37 P37-4204 TOP	72010 043 3000 72010 043 3100 72010 043 3200	Service Manual Supplement 1 Supplement 2	12.5
LEEMAXX 37 P37-4204 TOP	72010 044 4000	Service Manual	12.6
LEEMAXX 55 FLAT MF55-9101 DOLBY (VNA)	72010 041 6000 72010 041 6200	Service Manual Supplement 2	CUC 2136
LEEMAXX 55 FLAT MF55-9101 DOLBY (VNM)	72010 041 6000 72010 041 6200	Service Manual Supplement 2	CUC 2136
LEEMAXX 55 FLAT MF55-9101/8 DOLBY (VNM)	72010 041 6000 72010 041 6100	Service Manual Supplement 1	CUC 2136
LEEMAXX 55 FLAT MF55-9201 DOLBY (VNM)	72010 040 7000 72010 040 7600	Service Manual Supplement 6	CUC 2121
LEEMAXX 55 FLAT MF55-9201/8 DOLBY (VNM)	72010 040 7000 72010 040 7600	Service Manual Supplement 6	CUC 2121M
LEEMAXX 55 M55-4210 DOLBY (VNM)	72010 030 5000 72010 030 5400 72010 030 5500 72010 030 5700	Service Manual Supplement 4 Supplement 5 Supplement 7	CUC 1807
LEEMAXX 55 ST55-4105 DOLBY (VNA)	72010 040 7000 72010 040 7400	Service Manual Supplement 4	CUC 2121
LEEMAXX 55 ST55-4105 DOLBY (VNM)	72010 040 7000 72010 040 7200	Service Manual Supplement 2	CUC 2121
LEEMAXX 55 ST55-4105 MV/DOLBY (VNA)	72010 040 7000 72010 040 7200 72010 040 7500	Service Manual Supplement 2 Supplement 5	CUC 2121 M
LEEMAXX 55 ST55-4105 MV/DOLBY (VNM)	72010 040 7000 72010 040 7200	Service Manual Supplement 2	CUC 2121 M

Observe also the instructions given in the "Safety" Service Manual, part no. 72010 800 0000!

TV Set	Part Number	Kind of Manual	Chassis
LEEMAXX 55 ST55-4105 MV/DOLBY (VNX)	72010 040 7000 72010 040 7400	Service Manual Supplement 4	CUC 2121M
LEEMAXX 55 T55-4104 M/COM/CL (VNA)	72010 043 6000 72010 043 6100	Service Manual Supplement 1	CUC 2103H
LEEMAXX 55 T55-4104 M/HOT/CL (VNA)	72010 043 6000	Service Manual	CUC 2103H
LEEMAXX 55 T55-4104 M/HOT/CL (VNM)	72010 043 6000	Service Manual	CUC 2103H
LEEMAXX 55 T55-4104 TOP (VNA)	72010 040 7000 72010 040 7100 72010 040 7500	Service Manual Supplement 1 Supplement 5	CUC 2103
LEEMAXX 55 T55-4104 TOP (VNM)	72010 040 7000 72010 040 7200	Service Manual Supplement 2	CUC 2103
LEEMAXX 72 FLAT MF72-9101/8 DOLBY (VNM)	72010 041 6000 72010 041 6200	Service Manual Supplement 2	CUC 2131M
LEEMAXX 72 FLAT MF72-9101/8 DOLBY (VNMA)	72010 041 6000 72010 041 6200	Service Manual Supplement 2	CUC 2131M
LEEMAXX 72 FLAT MF72-9110/8 DOLBY (VNM)	72010 030 5000 72010 030 5400	Service Manual Supplement 4	CUC 1838
LEEMAXX 72 FLAT MF72-9115/8 DOLBY (VNA)	72010 030 5000 72010 030 5400 72010 030 5500	Service Manual Supplement 4 Supplement 5	CUC 1838
LEEMAXX 72 FLAT MF72-9115/8 DOLBY (VNM)	72010 030 5000 72010 030 5400 72010 030 5500	Service Manual Supplement 4 Supplement 5	CUC 1838
LENARO 82 MFW82-6210/9 DOLBY (VNM)	72010 042 3000 72010 042 3100 72010 042 4000	Service Manual Supplement 1 DVD-KIT	CUC 1935
LENARO 82 MFW82-6211/9 DVD (VNM)	72010 042 3000 72010 042 3100 72010 042 4000	Service Manual Supplement 1 DVD KIT	CUC 1935
LENARO 84 MF 84-6110/8 DOLBY (VNA)	72010 030 5000 72010 030 5400 72010 030 5500 72010 030 5600	Service Manual Supplement 4 Supplement 5 Supplement 6	CUC 1839
LENARO 84 MF 84-6110/8 DOLBY (VNX)	72010 030 5000 72010 030 5400 72010 030 5500 72010 030 5600	Service Manual Supplement 4 Supplement 5 Supplement 6	CUC 1839
LENARO 84 MF84-6110/8 DOLBY (VNM)	72010 030 5000 72010 030 5400	Service Manual Supplement 4	CUC 1839
LENARO 92 MFW 92-6110/9 DVD	Home Service		
LENARO 92 MFW92-6110/9 DVD (VNM)	72010 042 3000 72010 042 4000	Service Manual SM DVD	CUC 1937
LISSABON 562 SE5595 DOLBY (VNA)	72010 040 7000 72010 040 7400	Service Manual Supplement 4	CUC 2121
LISSABON 562 SE5595 DOLBY (VNM)	72010 040 7000	Service Manual	CUC 2121
M55-280/8 A IDTV LOG	72010 021 1000 72010 021 1200	Service Manual Supplement 2	CUC 1806
M55-290/8 IDTV	72010 021 1000 72010 021 1200 72010 021 1400 72010 021 1600	Service Manual Supplement 2 Supplement 4 Supplement 6	CUC 1806
M63-281 IDTV/LOG	72010 021 1000 72010 021 1200 72010 021 1300 72010 021 1400	Service Manual Supplement 2 Supplement 3 Supplement 4	CUC 1836

Observe also the instructions given in the "Safety" Service Manual, part no. 72010 800 0000!

TV Set	Part Number	Kind of Manual	Chassis
M63-281/8 IDTV/LOG	72010 021 1000	Service Manual	CUC 1836
	72010 021 1200	Supplement 2	
	72010 021 1300	Supplement 3	
	72010 021 1400	Supplement 4	
M70-281 IDTV/LOG	72010 021 1000	Service Manual	CUC 1836
	72010 021 1200	Supplement 2	
	72010 021 1300	Supplement 3	
	72010 021 1400	Supplement 4	
M70-281/8 IDTV/LOG	72010 021 1000	Service Manual	CUC 1836
	72010 021 1200	Supplement 2	
	72010 021 1300	Supplement 3	
	72010 021 1400	Supplement 4	
M70-282 (VNM)	72010 026 9000	Service Manual	CUC 1836
	72010 026 9100	Supplement 1	
M70-282 (VNX)	72010 026 9000	Service Manual	CUC 1936
	72010 026 9000	Supplement 1	
	72010 026 9000	Supplement 3	
M70-290 IDTV	72010 021 1000	Service Manual	CUC 1836
	72010 021 1200	Supplement 2	
	72010 021 1300	Supplement 3	
	72010 021 1400	Supplement 4	
M70-290/8 IDTV	72010 021 1000	Service Manual	CUC 1836
	72010 021 1200	Supplement 2	
	72010 021 1300	Supplement 3	
	72010 021 1400	Supplement 4	
M70-879/8 DOLBY (VNA)	72010 030 5000	Service Manual	CUC 1837
	72010 030 5400	Supplement 4	
	72010 030 5500	Supplement 5	
	72010 030 5600	Supplement 6	
M70-879/8 DOLBY (VNM)	72010 030 5000	Service Manual	CUC 1837
	72010 030 5100	Supplement 1	
M72-01 (VNM/VNA)	72010 026 9000	Service Manual	CUC 1830
	72010 026 9000	Supplement 1	
	72010 026 9000	Supplement 3	
M72-100 A	72010 021 1000	Service Manual	CUC 1830
	72010 021 1200	Supplement 2	
M72-100/8 A	72010 021 1000	Service Manual	CUC 1830
	72010 021 1200	Supplement 2	
M72-109 (VNM)	72010 026 9000	Service Manual	CUC 1830
	72010 026 9100	Supplement 1	
M72-109 MV/DOLBY (VNA)	72010 030 5000	Service Manual	CUC 1838
	72010 030 5400	Supplement 4	
	72010 030 5500	Supplement 5	
	72010 030 5600	Supplement 6	
M72-109 MV/DOLBY (VNM)	72010 030 5000	Service Manual	CUC 1838
	72010 030 5100	Supplement 1	
	72010 030 5200	Supplement 2	
M72-109 MV/DOLBY (VNX)	72010 030 5000	Service Manual	CUC 1838
	72010 030 5400	Supplement 4	
	72010 030 5500	Supplement 5	
	72010 030 5600	Supplement 6	
M72-270/8 IDTV/LOG ELEGANCE	72010 019 3000	Service Manual	CUC 1826
	72010 019 3100	Supplement 1	
	72010 019 3200	Supplement 2	
	72010 019 3300	Supplement 3	
	72010 019 3600	Supplement 6	
M72-610/8 DOLBY (VNM)	72010 030 5000	Service Manual	CUC 1838
	72010 030 5400	Supplement 4	
	72010 030 5500	Supplement 5	

Observe also the instructions given in the "Safety" Service Manual, part no. 72010 800 0000!

TV Set	Part Number	Kind of Manual	Chassis
M72-620/8 DOLBY (VNM)	72010 030 5000 72010 030 5400 72010 030 5500	Service Manual Supplement 4 Supplement 5	CUC 1838
M72-798 DOLBY (VNA)	72010 030 5000 72010 030 5400 72010 030 5500 72010 030 5600	Service Manual Supplement 4 Supplement 5 Supplement 6	CUC 1838
M72-798 DOLBY (VNM)	72010 030 5000 72010 030 5100 72010 030 5200	Service Manual Supplement 1 Supplement 2	CUC 1838
M72-798 DOLBY (VNX)	72010 030 5000 72010 030 5400 72010 030 5500 72010 030 5600	Service Manual Supplement 4 Supplement 5 Supplement 6	CUC 1838
M72-798 IDTV	72010 021 1000 72010 021 1200 72010 021 1400 72010 021 1900	Service Manual Supplement 2 Supplement 4 Supplement 9	CUC 1830
M84-210/8 A IDTV LOG	72010 021 1000 72010 021 1200	Service Manual Supplement 2	CUC 1829
M84-211/8 IDTV (VNM)	72010 021 1000 72010 021 1200 72010 021 1300 72010 021 1400 72010 021 1800	Service Manual Supplement 2 Supplement 3 Supplement 4 Supplement 8	CUC 1929
M84-212/8 DOLBY (VNA)	72010 030 5000 72010 030 5400 72010 030 5500 72010 030 5600	Service Manual Supplement 4 Supplement 5 Supplement 6	CUC 1839
M84-212/8 DOLBY (VNM)	72010 030 5000 72010 030 5100	Service Manual Supplement 1	CUC 1839
MELBOURNE SE7210 A NIC/TOP	72010 020 7000 72010 020 7100 72010 020 7300 72010 020 7400	Service Manual Supplement 1 Supplement 3 Supplement 4	CUC 2051 N
MELBOURNE SE7212 TOP (VNM)	72010 024 8000	Service Manual	CUC 2033
MF72-2210 DOLBY (VNM)	72010 030 5000 72010 030 5400 72010 030 5500	Service Manual Supplement 4 Supplement 5	CUC 1838
MF72-258 DOLBY (VNA)	72010 030 5000 72010 030 5400 72010 030 5500 72010 030 5600	Service Manual Supplement 4 Supplement 5 Supplement 6	CUC 1838
MF72-258 DOLBY (VNM)	72010 030 5000 72010 030 5200 72010 030 5300	Service Manual Supplement 2 Supplement 3	CUC 1838
MF72-258 DOLBY (VNM)	72010 030 5000 72010 030 5400 72010 030 5500	Service Manual Supplement 4 Supplement 5	CUC 1935
MIAMI SE3780 TEXT	72010 019 4000 72010 019 4300 72010 019 4600	Service Manual Supplement 3 Supplement 6	CUC 7303
MW70-2203 FR/DOLBY (VNM)	72010 044 1000	Service Manual	CUC 2069 F
MW70-2203 NIC/DOLBY (VNM)	72010 043 1000 72010 043 1100	Service Manual Supplement 1	CUC 2069 N
MW70-269 PALPLUS	72010 019 9000 72010 019 9100 72010 019 9200 72010 019 9400	Service Manual Supplement 1 Supplement 2 Supplement 4	CUC 1952

Observe also the instructions given in the "Safety" Service Manual, part no. 72010 800 0000!

TV Set	Part Number	Kind of Manual	Chassis
MW70-2690 FR/TOP	72010 020 8000 72010 020 8200 72010 020 8300	Service Manual Supplement 2 Supplement 3	CUC 2059 F
MW70-2690 NIC/TOP	72010 020 7000 72010 020 7100 72010 020 7300 72010 020 7400	Service Manual Supplement 1 Supplement 3 Supplement 4	CUC 2059 N
MW70-2699 DPL/FT (VNM)	72010 020 7000 72010 020 7400 72010 020 7600 72010 020 7800	Service Manual Supplement 4 Supplement 6 Supplement 8	CUC 2059 N
MW70-2699 FR/TOP (VNM)	72010 020 8000 72010 020 8200 72010 020 8400	Service Manual Supplement 2 Supplement 4	CUC 2059 F
MW70-2699 NIC/FT (VNM)	72010 026 0000	Service Manual	CUC 2059N
MW70-2699 NIC/FT (VNM)	72010 026 0000	Service Manual	CUC 2059 N
MW70-2699 NIC/TOP (VNA)	72010 026 0000	Service Manual	CUC 2059N
MW70-2699 NIC/TOP (VNA)	72010 026 0000	Service Manual	CUC 2059 N
MW70-2699 NIC/TOP (VNM)	72010 020 7000 72010 020 7400 72010 020 7600 72010 020 7800	Service Manual Supplement 4 Supplement 6 Supplement 8	CUC 2059 N
MW70-2700 Dolby (VNM)	72010 026 0000 72010 026 0200	Service Manual Supplement 2	CUC 2059
MW70-2700 FR/DOLBY (VNM)	72010 020 8000 72010 020 8200 72010 020 8400 72010 020 8700 72010 020 8800	Service Manual Supplement 2 Supplement 4 Supplement 7 Supplement 8	CUC 2059F
MW70-2700 NIC/DOLBY (VNA)	72010 026 0000 72010 026 0300 72010 026 0400	Service Manual Supplement 3 Supplement 4	CUC 2059 N
MW70-2701 DOLBY/FT (VNM)	72010 026 0300 72010 026 0000	Service Manual Supplement 3	CUC 2059 N
MW70-3699 DOLBY/FT (VNM)	72010 026 0300 72010 026 0000	Service Manual Supplement 3	CUC 2059 N
MW70-3699 NIC/FT (VNM)	72010 026 0000 72010 026 0100	Service Manual Supplement 1	CUC 2059N
MW70-3700 DPL/FT (VNM)	72010 026 0000 72010 026 0100	Service Manual Supplement 1	CUC 2059N
MW82-100/9	72010 019 9000 72010 019 9100 72010 019 9200 72010 019 9400	Service Manual Supplement 1 Supplement 2 Supplement 4	CUC 1984
MW82-100/9 PALPLUS	72010 019 9000 72010 019 9100 72010 019 9200 72010 019 9400	Service Manual Supplement 1 Supplement 2 Supplement 4	CUC 1983
MW82-2203 NIC/DOLBY (VNM)	72010 043 1000 72010 043 1100	Service Manual Supplement 1	CUC 2068 N
MW82-2210/8 DOLBY (VNA)	72010 030 5000 72010 030 5400 72010 030 5500	Service Manual Supplement 4 Supplement 5	CUC 1935
MW82-2210/8 DOLBY (VNM)	72010 030 5000 72010 030 5400 72010 030 5500	Service Manual Supplement 4 Supplement 5	CUC 1935

Observe also the instructions given in the "Safety" Service Manual, part no. 72010 800 0000!

TV Set	Part Number	Kind of Manual	Chassis
MW82-2690 NIC/TOP	72010 020 7000	Service Manual	CUC 2058 N
	72010 020 7100	Supplement 1	
	72010 020 7300	Supplement 3	
	72010 020 7400	Supplement 4	
MW82-2699 DPL/FT (VNM)	72010 020 7000	Service Manual	CUC 2058 N
	72010 020 7400	Supplement 4	
	72010 020 7600	Supplement 6	
	72010 020 7800	Supplement 8	
MW82-2699 FR/TOP (VNM)	72010 020 8000	Service Manual	CUC 2058 F
	72010 020 8200	Supplement 2	
	72010 020 8400	Supplement 4	
MW82-2699 NIC/FT (VNM)	72010 026 0000	Service Manual	CUC 2058N
MW82-2699 NIC/FT (VNM)	72010 026 0000	Service Manual	CUC 2058 N
MW82-2699 NIC/TOP (VNA)	72010 026 0000	Service Manual	CUC 2058N
MW82-2699 NIC/TOP (VNA)	72010 026 0000	Service Manual	CUC 2058 N
MW82-2699 NIC/TOP (VNM)	72010 020 7000	Service Manual	CUC 2058 N
	72010 020 7400	Supplement 4	
	72010 020 7600	Supplement 6	
	72010 020 7800	Supplement 8	
MW82-2700 Dolby (VNM)	72010 026 0000	Service Manual	CUC 2058
	72010 026 0200	Supplement 2	
MW82-2700 FR/Dolby (VNM)	72010 020 8000	Service Manual	CUC 2058F
	72010 020 8200	Supplement 2	
	72010 020 8400	Supplement 4	
	72010 020 8700	Supplement 7	
	72010 020 8800	Supplement 8	
MW82-2700 NIC/DOLBY (VNM)	72010 026 0000	Service Manual	CUC 2058 N
	72010 026 0300	Supplement 3	
	72010 026 0400	Supplement 4	
MW82-2701 DOLBY/FT (VNM)	72010 026 0300	Service Manual	CUC 2058 N
	72010 026 0000	Supplement 3	
MW82-3112 MV/DOLBY (VNA)	72010 030 5000	Service Manual	CUC 1935
	72010 030 5400	Supplement 4	
	72010 030 5500	Supplement 5	
	72010 030 5600	Supplement 6	
MW82-3112 MV/DOLBY (VNM)	72010 030 5000	Service Manual	CUC 1935
	72010 030 5100	Supplement 1	
MW82-3699 DOLBY/FT (VNM)	72010 026 0300	Service Manual	CUC 2058 N
	72010 026 0000	Supplement 3	
MW82-3699 NIC/FT (VNM)	72010 026 0000	Service Manual	CUC 2058N
	72010 026 0100	Supplement 1	
MW82-3700 DPL/FT (VNM)	72010 026 0000	Service Manual	CUC 2058N
	72010 026 0100	Supplement 1	
MW82-40/8 (VNM)	72010 026 9000	Service Manual	CUC 1836
MW82-45/8 (VNM)	72010 026 9000	Service Manual	CUC 1929
	72010 026 9000	Supplement 1	
	72010 026 9000	Supplement 3	
MW82-50/8	72010 021 1000	Service Manual	CUC 1929
	72010 021 1200	Supplement 2	
	72010 021 1300	Supplement 3	
ORLANDO FLAT SE7270 DOLBY (VNG)	72010 030 5000	Service Manual	CUC 1838
	72010 030 5400	Supplement 4	
	72010 030 5500	Supplement 5	
	72010 030 5600	Supplement 6	
ORLANDO FLAT SE7270 DOLBY (VNM)	72010 030 5000	Service Manual	CUC 1838
	72010 030 5400	Supplement 4	

Observe also the instructions given in the "Safety" Service Manual, part no. 72010 800 0000!

TV Set	Part Number	Kind of Manual	Chassis
ORLANDO FLAT SE7270 DOLBY (VNX)	72010 030 5000	Service Manual	CUC 1838
	72010 030 5400	Supplement 4	
	72010 030 5500	Supplement 5	
	72010 030 5600	Supplement 6	
P37-080	72010 019 4000	Service Manual	CUC 7303
	72010 019 4300	Supplement 3	
	72010 019 4600	Supplement 6	
P37-080 (VNA)	72010 026 1000	Service Manual	CUC 7303
	72010 026 1100	Supplement 1	
P37-080 GB	72010 019 4000	Service Manual	CUC 7303
	72010 019 4600	Supplement 6	
	72010 019 4700	Supplement 7	
P37-080 GB (VNA)	72010 026 1000	Service Manual	CUC 7303
	72010 026 1100	Supplement 1	
	72010 026 1300	Supplement 3	
P37-080 IR	72010 019 4000	Service Manual	CUC 7303
	72010 019 4600	Supplement 6	
	72010 019 4700	Supplement 7	
P37-080 IR (VNA)	72010 026 1000	Service Manual	CUC 7303
	72010 026 1100	Supplement 1	
P37-080 TR (VNM)	72010 019 4000	Service Manual	CUC 7303
	72010 019 4600	Supplement 6	
	72010 021 9100	Supplement 11	
P37-090 GB (VNA)	72010 026 1000	Service Manual-	CUC 7303
	72010 026 1100	Supplement 2	
	72010 026 1300	Supplement 3	
P37-090 GB (VNM)	72010 019 4000	Service Manual	CUC 7303 GB
	72010 019 4600	Supplement 6	
	72010 021 9200	Supplement 12	
P37-090 IR (VNM)	72010 026 1000	Service Manual	CUC 7303 with PLL
	72010 026 1100	Supplement 1	
	72010 026 1200	Supplement 2	
P37-1201/5 TOP	72010 044 4000	Service Manual	12.6
P37-3050 text (VNM)	72010 026 1000	Service Manual	CUC 7303 with PLL
	72010 026 1100	Supplement 1	
	72010 026 1200	Supplement 2	
P37-3050 TR (VNM)	72010 026 1000	Service Manual	CUC 7303
	72010 026 1100	Supplement 1	
	72010 026 1300	Supplement 3	
P37-600 TEXT (VNM)	72010 026 1000	Service Manual	CUC 7303 with PLL
	72010 026 1100	Supplement 1	
	72010 026 1200	Supplement 2	
P37-830 MULTI/ICN	72010 024 0000	Service Manual	CUC 2003 H
P37-830 MULTI/ICN	72010 024 0000	Service Manual	CUC 2003 H
	72010 024 0100	Supplement 1	
P37-830 TEXT	72010 019 4000	Service Manual	CUC 7303
	72010 019 4300	Supplement 3	
	72010 019 4600	Supplement 6	
P37-830 TEXT (VNA)	72010 026 1000	Service Manual	CUC 7303
	72010 026 1100	Supplement 1	
P37-830 TEXT/GB	72010 019 4000	Service Manual	CUC 7303
	72010 019 4600	Supplement 6	
	72010 019 4700	Supplement 7	
P37-830 TEXT/GB (VNA)	72010 026 1000	Service Manual	CUC 7303
	72010 026 1100	Supplement 1	
	72010 026 1300	Supplement 3	

Observe also the instructions given in the "Safety" Service Manual, part no. 72010 800 0000!

TV Set	Part Number	Kind of Manual	Chassis
P37-830 TEXT/IR	72010 019 4000 72010 019 4600 72010 019 4700	Service Manual Supplement 6 Supplement 7	CUC 7303
P37-830 text/IR (VNA)	72010 026 1000 72010 026 1100	Service Manual Supplement 1	CUC 7303
P37-830 text/TR (VNA)	72010 026 1000 72010 026 1100 72010 026 1200	Service Manual Supplement 1 Supplement 2	CUC 7303 with PLL
P37-830 TEXT/TR (VNM)	72010 019 4000 72010 019 4600 72010 021 9100	Service Manual Supplement 6 Supplement 11	CUC 7303
P37-830/12 TEXT GLOBETROTTER	72010 019 5000 72010 019 5100	Service Manual Supplement 1	CUC 7305
P37-830/12 TEXT GLOBETROTTER (VNA)	72010 028 9000	Service Manual	CUC 7305
P37-830/4 TEXT	72010 019 4000 72010 019 4300 72010 019 4600	Service Manual Supplement 3 Supplement 6	CUC 7303
P37-830/4 text (VNA)	72010 026 1000 72010 026 1100	Service Manual Supplement 1	CUC 7303
P37-837 text (VNA)	72010 026 1000 72010 026 1100	Service Manual Supplement 1	CUC 7303
P37-837 TEXT (VNM)	72010 019 4000 72010 019 4600 72010 021 9000	Service Manual Supplement 6 Supplement 10	CUC 7303
P37-838 text (VNA)	72010 026 1000 72010 026 1100	Service Manual Supplement 1	CUC 7303
P37-838 TEXT (VNM)	72010 019 4000 72010 019 4600 72010 021 9000	Service Manual Supplement 6 Supplement 10	CUC 7303
P37-840/12 TOP/SAT	72010 026 2000	Service Manual	CUC 2005
P37-842 FR	72010 019 6000 72010 019 6300	Service Manual Supplement 3	CUC 7303 FR
P37-844 FR (VNA)	72010 025 7000	Service Manual	CUC 7303F
P37-844 FR (VNA)	72010 025 7000	Service Manual	CUC 7303 F
P37-847 FR/TEXT	72010 019 6000 72010 019 6300 72010 019 6400	Service Manual Supplement 3 Supplement 4	CUC 7303 FR
P37-848 FR Text (VNA)	72010 025 7000	Service Manual	CUC 7303F
P37-848 FR TEXT (VNA)	72010 025 7000	Service Manual	CUC 7303 F
P37-930 TEXT/GB (VNA)	72010 026 1000 72010 026 1100 72010 026 1300	Service Manual Supplement 1 Supplement 3	CUC 7303
P37-930 text/IR (VNM)	72010 026 1000 72010 026 1100 72010 026 1200	Service Manual Supplement 1 Supplement 2	CUC 7303 with PLL
P37-9441 FR (VNM)	72010 019 6000 72010 019 6300 72010 019 6600	Service Manual Supplement 3 Supplement 6	CUC 7303F
P37-9441 FR (VNM)	72010 019 6000 72010 019 6300 72010 019 6600	Service Manual Supplement 3 Supplement 6	CUC 7303 F
P37-9442 FR (VNM)	72010 019 6000 72010 019 6300 72010 019 6600	Service Manual Supplement 3 Supplement 6	CUC 7303F
P37-9442 FR (VNM)	72010 019 6000 72010 019 6300 72010 019 6600	Service Manual Supplement 3 Supplement 6	CUC 7303 F

Observe also the instructions given in the "Safety" Service Manual, part no. 72010 800 0000!

TV Set	Part Number	Kind of Manual	Chassis
P37-9443 FR (VNM)	72010 019 6000 72010 019 6300 72010 019 6600	Service Manual Supplement 3 Supplement 6	CUC 7303F
P37-9443 FR (VNM)	72010 019 6000 72010 019 6300 72010 019 6600	Service Manual Supplement 3 Supplement 6	CUC 7303 F
P45 830/4 TEXT (VNA)	72010 026 1000	Service Manual	CUC 7303
P45-4101 MV/TOP (VNA)	72010 040 7000 72010 040 7100 72010 040 7500	Service Manual Supplement 1 Supplement 5	CUC 2103
P45-4101 MV/TOP (VNM)	72010 040 7000 72010 040 7200	Service Manual Supplement 2	CUC 2103
P45-4101 TOP (VNA)	72010 040 7000 72010 040 7100 72010 040 7500	Service Manual Supplement 1 Supplement 5	CUC 2103
P45-4101 TOP (VNM)	72010 040 7000 72010 040 7200	Service Manual Supplement 2	CUC 2103
P45-830 MULTI MEGASIS	72010 024 0000	Service Manual	CUC 2003 H
P45-830 MULTI MEGASIS	72010 024 0000 72010 024 0100	Service Manual Supplement 1	CUC 2003 H
P45-830 TEXT	72010 019 4000 72010 019 4300 72010 019 4600	Service Manual Supplement 3 Supplement 6	CUC 7303
P45-830 TEXT (VNA)	72010 026 1000	Service Manual	CUC 7303
P45-830/4 TEXT	72010 019 4000 72010 019 4600 72010 019 4700	Service Manual Supplement 6 Supplement 7	CUC 7303
P45-848 FR Text (VNA)	72010 025 7000	Service Manual	CUC 7303F
P45-848 FR TEXT (VNA)	72010 025 7000	Service Manual	CUC 7303 F
PLANATRON 110/1E	Home Service		
PLANATRON 110/1F	Home Service		
PLANATRON PW 110-520/9 PAL PLUS	Home Service		
PLANATRON PW 110-520/9 PAL PLUS	Home Service		
PLANATRON PW 110-520/9 PALPLUS (VNM)	72010 024 6000	Service Manual	
PLANATRON PW110-520/9 PALPLUS	72010 024 6000	Service Manual	
ROME FLAT SE8270 DOLBY (VNM)	72010 030 5000 72010 030 5400 72010 030 5500 72010 030 5700	Service Manual Supplement 4 Supplement 5 Supplement 7	CUC 1935
S55-806 TOP/TR (VNA)	72010 040 7000 72010 040 7100 72010 040 7500	Service Manual Supplement 1 Supplement 5	CUC 2103
S55-806 TOP/TR (VNM)	72010 040 7000 72010 040 7100	Service Manual Supplement 1	CUC 2103
SEDANCE 70 ST70-2104 DOLBY (VNM)	72010 041 6000 72010 041 6100	Service Manual Supplement 1	CUC 2130
SEDANCE 70 ST70-2104/8 DOLBY (VNA)	72010 041 6000 72010 041 6200	Service Manual Supplement 2	CUC 2130M
SEDANCE 70 ST70-2104/8 DOLBY (VNM)	72010 041 6000 72010 041 6100	Service Manual Supplement 1	CUC 2130M
SEDANCE 70 ST70-2205 FR/DOLBY (VNM/ VNA)	72010 044 1000	Service Manual	CUC 2060 F
SEDANCE 70 ST70-284 DOLBY (VNA)	72010 030 5000 72010 030 5400 72010 030 5500 72010 030 5600	Service Manual Supplement 4 Supplement 5 Supplement 6	CUC 1837

Observe also the instructions given in the "Safety" Service Manual, part no. 72010 800 0000!

TV Set	Part Number	Kind of Manual	Chassis
SEDANCE 70 ST70-284 DOLBY (VNG)	72010 030 5000 72010 030 5400 72010 030 5500 72010 030 5600	Service Manual Supplement 4 Supplement 5 Supplement 6	CUC 1837
SEDANCE 70 ST70-284 DOLBY (VNM)	72010 030 5000 72010 030 5100	Service Manual Supplement 1	CUC 1837
SEDANCE 70 ST70-284 DOLBY (VNR)	72010 030 5000 72010 030 5400 72010 030 5500 72010 030 5600	Service Manual Supplement 4 Supplement 5 Supplement 6	CUC 1837
SEDANCE 70 ST70-284 DOLBY (VNU)	72010 030 5000 72010 030 5400 72010 030 5500 72010 030 5600	Service Manual Supplement 4 Supplement 5 Supplement 6	CUC 1837
SEDANCE 70 ST70-284 DOLBY (VNX)	72010 030 5000 72010 030 5400 72010 030 5500 72010 030 5600	Service Manual Supplement 4 Supplement 5 Supplement 6	CUC 1837
SEDANCE 70 ST70-284/8 DOLBY (VNA)	72010 030 5000 72010 030 5400 72010 030 5500 72010 030 5600	Service Manual Supplement 4 Supplement 5 Supplement 6	CUC 1837
SEDANCE 70 ST70-284/8 DOLBY (VNG)	72010 030 5000 72010 030 5400 72010 030 5500 72010 030 5600	Service Manual Supplement 4 Supplement 5 Supplement 6	CUC 1837
SEDANCE 70 ST70-284/8 DOLBY (VNM)	72010 030 5000 72010 030 5100	Service Manual Supplement 1	CUC 1837
SEDANCE 70 ST70-284/8 DOLBY (VNR)	72010 030 5000 72010 030 5400 72010 030 5500 72010 030 5600	Service Manual Supplement 4 Supplement 5 Supplement 6	CUC 1837
SEDANCE 70 ST70-284/8 DOLBY (VNU)	72010 030 5000 72010 030 5400 72010 030 5500 72010 030 5600	Service Manual Supplement 4 Supplement 5 Supplement 6	CUC 1837
SEDANCE 70 ST70-284/8 DOLBY (VNX)	72010 030 5000 72010 030 5400 72010 030 5500 72010 030 5600	Service Manual Supplement 4 Supplement 5 Supplement 6	CUC 1837
SEDANCE 70 ST70-285/8 DOLBY (VNM,VNA)	72010 030 5000 72010 030 5400 72010 030 5500	Service Manual Supplement 4 Supplement 5	CUC 1837
SEDANCE 70 ST70-285/8 DOLBY (VNX,VNG)	72010 030 5000 72010 030 5400 72010 030 5500	Service Manual Supplement 4 Supplement 5	CUC 1837
SEDANCE 70 ST70-5101 DOLBY (VNA)	72010 041 6000 72010 041 6200	Service Manual Supplement 2	CUC 2130
SEDANCE 72 M72-2110 DOLBY (VNA)	72010 030 5000 72010 030 5400 72010 030 5500 72010 030 5600	Service Manual Supplement 4 Supplement 5 Supplement 6	CUC 1838
SEDANCE 72 M72-2110 DOLBY (VNG)	72010 030 5000 72010 030 5400 72010 030 5500 72010 030 5600	Service Manual Supplement 4 Supplement 5 Supplement 6	CUC 1838
SEDANCE 72 M72-2110 DOLBY (VNM)	72010 030 5000 72010 030 5100	Service Manual Supplement 1	CUC 1838

Observe also the instructions given in the "Safety" Service Manual, part no. 72010 800 0000!

TV Set	Part Number	Kind of Manual	Chassis
SEDANCE 72 M72-2110 DOLBY (VNX)	72010 030 5000 72010 030 5400 72010 030 5500 72010 030 5600	Service Manual Supplement 4 Supplement 5 Supplement 6	CUC 1838
SEDANCE 72 M72-2110 MV/DOLBY (VNA)	72010 030 5000 72010 030 5400 72010 030 5500 72010 030 5600	Service Manual Supplement 4 Supplement 5 Supplement 6	CUC 1838
SEDANCE 72 M72-2110 MV/DOLBY (VNG)	72010 030 5000 72010 030 5400 72010 030 5500 72010 030 5600	Service Manual Supplement 4 Supplement 5 Supplement 6	CUC 1838
SEDANCE 72 M72-2110 MV/DOLBY (VNM)	72010 030 5000 72010 030 5100	Service Manual Supplement 1	CUC 1838
SEDANCE 72 M72-2110 MV/DOLBY (VNX)	72010 030 5000 72010 030 5400 72010 030 5500 72010 030 5600	Service Manual Supplement 4 Supplement 5 Supplement 6	CUC 1838
SEDANCE 72 ST72-2104 DOLBY (VNA)	72010 041 6000 72010 041 6200	Service Manual Supplement 2	CUC 2131
SEDANCE 72 ST72-2104 DOLBY (VNM)	72010 041 6000 72010 041 6200	Service Manual Supplement 2	CUC 2131
SEDANCE 72 ST72-2104/8 DOLBY (VNA)	72010 041 6000 72010 041 6200	Service Manual Supplement 2	CUC 2131M
SEDANCE 72 ST72-2104/8 DOLBY (VNM)	72010 041 6000 72010 041 6200	Service Manual Supplement 2	CUC 2131M
SEDANCE 72 ST72-8610 NIC/DOLBY (VNA)	72010 024 8000 72010 024 8300	Service Manual Supplement 3	CUC 2033N
ST25-8210/6 NT	72010 020 7000 72010 020 7100 72010 020 7300	Service Manual Supplement 1 Supplement 3	CUC 2040 India
ST28-8210/6 NT	72010 020 7000 72010 020 7100 72010 020 7300	Service Manual Supplement 1 Supplement 3	CUC 2040 India
ST55-605 TOP (VNM)	72010 024 7000 72010 024 7300	Service Manual Supplement 3	CUC 2021
ST55-710 NIC/TOP	72010 021 4000	Service Manual	CUC 2020 N
ST55-715 NIC/TOP (VNM)	72010 024 7000 72010 024 7200	Service Manual Supplement 2	CUC 2021 N
ST55-725 A FT/GB	72010 021 4000	Service Manual	CUC 2020 N
ST55-725 B FT/TOP (VNM)	72010 024 7000 72010 024 7200	Service Manual Supplement 2	CUC 2021 N
ST55-730 GB/Dolby (VNM)	72010 024 7000 72010 024 7300	Service Manual Supplement 3	CUC 2021N
ST55-730 S/GB/DOLBY (VNM)	72010 024 7000 72010 024 7300 72010 024 7400	Service Manual Supplement 3 Supplement 4	CUC 2021 N
ST55-734 GB/DOLBY (VNA)	72010 040 7000 72010 040 7400	Service Manual Supplement 4	CUC 2121GB
ST55-734 GB/DOLBY (VNM)	72010 040 7000 72010 040 7100	Service Manual Supplement 1	CUC 2121 GB
ST55-734 GB/DOLBY (VNX)	72010 040 7000 72010 040 7400	Service Manual Supplement 4	CUC 2121GB
ST55-750 FR/TOP	72010 021 8000 72010 021 8100	Service Manual Supplement 1	CUC 2020 FR
ST55-798 TEXT	72010 016 8000 72010 016 8500 72010 016 8700	Service Manual Supplement 5 Supplement 7	CUC 7350

Observe also the instructions given in the "Safety" Service Manual, part no. 72010 800 0000!

TV Set	Part Number	Kind of Manual	Chassis
ST55-798 TEXT	72010 016 8000 72010 016 8500 72010 016 8700	Service Manual Supplement 5 Supplement 7	CUC 7350
ST55-800 A TOP	72010 021 4000	Service Manual	CUC 2020
ST55-800 NIC/TOP	72010 021 4000	Service Manual	CUC 2020 N
ST55-805 NIC/TOP (VNM)	72010 024 7000 72010 024 7200	Service Manual Supplement 2	CUC 2021 N
ST55-805 TOP (VNM)	72010 024 7000	Service Manual	CUC 2021
ST55-805 TOP/TR (VNM)	72010 024 7000	Service Manual	CUC 2021
ST55-825 FT/GB (VNM)	72010 024 7000 72010 024 7200	Service Manual Supplement 2	CUC 2021 N
ST55-829 NIC/Dolby (VNM)	72010 024 7000 72010 024 7300	Service Manual Supplement 3	CUC 2021N
ST55-834 GB/DOLBY (VNM)	72010 024 7000 72010 024 7300 72010 024 7400	Service Manual Supplement 3 Supplement 4	CUC 2021 N
ST55-839 DOLBY (VNM)	72010 040 7000 72010 040 7600	Service Manual Supplement 6	CUC 2121
ST55-839/8 DOLBY (VNA)	72010 040 7000 72010 040 7400	Service Manual Supplement 4	CUC 2121M
ST55-839/8 DOLBY (VNG)	72010 040 7000 72010 040 7400	Service Manual Supplement 4	CUC 2121M
ST55-839/8 DOLBY (VNM)	72010 040 7000	Service Manual	CUC 2121 M
ST55-839/8 DOLBY (VNR)	72010 040 7000 72010 040 7400	Service Manual Supplement 4	CUC 2121M
ST55-850 FR / TOP	72010 021 8000	Service Manual	CUC 2020 FR
ST55-850 NIC/TOP	72010 021 4000	Service Manual	CUC 2020 N
ST55-850 TOP	72010 021 4000	Service Manual	CUC 2020
ST55-855 TOP (VNM)	72010 024 7000	Service Manual	CUC 2021
ST55-898 DOLby (VNM)	72010 024 7000 72010 024 7300	Service Manual Supplement 3	CUC 2021
ST55-898 TOP (VNM)	72010 024 7000 72010 024 7200	Service Manual Supplement 2	CUC 2021 N
ST55-900 FR / TOP	72010 021 8000	Service Manual	CUC 2020 FR
ST55-905 FR/TOP (VNM)	72010 027 2000	Service Manual	CUC 2021F
ST55-906 FR/DOLBY (VNM)	72010 027 2000 72010 027 2100 72010 027 2200	Service Manual Supplement 1 Supplement 2	CUC 2021 F
ST55-908 DOLBY (VNA)	72010 040 7000 72010 040 7400	Service Manual Supplement 4	CUC 2121
ST55-908 DOLBY (VNM)	72010 040 7000	Service Manual	CUC 2121
ST55-908 DOLBY (VNX)	72010 040 7000 72010 040 7600	Service Manual Supplement 6	CUC 2121
ST55-908/8 DOLBY (VNA)	72010 040 7000 72010 040 7500	Service Manual Supplement 5	CUC 2121 M
ST55-908/8 DOLBY (VNM)	72010 040 7000	Service Manual	CUC 2121 M
ST55-908/8 DOLBY (VNX)	72010 040 7000 72010 040 7400	Service Manual Supplement 4	CUC 2121M
ST55-908/8 FR/DOLBY (VNM)	72010 041 1000	Service Manual	CUC 2121 F
ST55-934 GB/DOLBY (VNA)	72010 040 7000 72010 040 7400	Service Manual Supplement 4	CUC 2121GB
ST55-934 GB/DOLBY (VNG)	72010 040 7000 72010 040 7400	Service Manual Supplement 4	CUC 2121GB
ST55-934 GB/DOLBY (VNM)	72010 040 7000 72010 040 7100	Service Manual Supplement 1	CUC 2121 GB

Observe also the instructions given in the "Safety" Service Manual, part no. 72010 800 0000!

TV Set	Part Number	Kind of Manual	Chassis
ST55-934 GB/DOLBY (VNX)	72010 040 7000 72010 040 7400	Service Manual Supplement 4	CUC 2121GB
ST55-998 DOLBY (VNA)	72010 040 7000 72010 040 7400	Service Manual Supplement 4	CUC 2121
ST55-998 DOLBY (VNM)	72010 040 7000	Service Manual	CUC 2121
ST63-270/8 IDTV	72010 019 3000 72010 019 3100 72010 019 3200 72010 019 3300 72010 019 3600	Service Manual Supplement 1 Supplement 2 Supplement 3 Supplement 6	CUC 1825
ST63-270/8 IDTV	72010 021 1000 72010 021 1200 72010 021 1300 72010 021 1400	Service Manual Supplement 2 Supplement 3 Supplement 4	CUC 1836
ST63-270/8 IDTV 2 (VNA)	72010 026 9000 72010 026 9000 72010 026 9000	Service Manual Supplement 1 Supplement 3	CUC 1936
ST63-700 A NIC/FT (VNM)	72010 020 7000 72010 020 7100 72010 020 7400 72010 020 7800 72010 020 7900	Service Manual Supplement 1 Supplement 4 Supplement 8 Supplement 9	CUC 2030 N
ST63-701 NIC/TOP (VNM)	72010 020 7000 72010 020 7100 72010 020 7400 72010 020 7800 72010 020 7900	Service Manual Supplement 1 Supplement 4 Supplement 8 Supplement 9	CUC 2030 N
ST63-702 NIC/TOP (VNM)	72010 020 7000 72010 020 7100 72010 020 7400 72010 020 7800 72010 020 7900	Service Manual Supplement 1 Supplement 4 Supplement 8 Supplement 9	CUC 2030 N
ST63-702 TOP (VNM)	72010 024 8000	Service Manual	CUC 2032
ST63-702/8 DOLBY (VNA)	72010 041 6000 72010 041 6200	Service Manual Supplement 2	CUC 2130M
ST63-702/8 DOLBY (VNM)	72010 041 6000 72010 041 6100	Service Manual Supplement 1	CUC 2130M
ST63-705 FR/TOP (VNM)	72010 020 8000 72010 020 8200 72010 020 8300 72010 020 8500	Service Manual Supplement 2 Supplement 3 Supplement 5	CUC 2035 F
ST63-705 NIC/TEXT	72010 020 7000 72010 020 7100 72010 020 7300 72010 020 7400	Service Manual Supplement 1 Supplement 3 Supplement 4	CUC 2030 N
ST63-706 NIC/TOP (VNM)	72010 020 7000 72010 020 7100 72010 020 7400 72010 020 7800 72010 020 7900	Service Manual Supplement 1 Supplement 4 Supplement 8 Supplement 9	CUC 2030 N
ST63-712 NIC/TOP (VNM)	72010 020 7000 72010 020 7100 72010 020 7400 72010 020 7800 72010 020 7900	Service Manual Supplement 1 Supplement 4 Supplement 8 Supplement 9	CUC 2030 N
ST63-713/8 DOLBY (VNA)	72010 041 6000 72010 041 6200	Service Manual Supplement 2	CUC 2130M
ST63-713/8 DOLBY (VNM)	72010 041 6000 72010 041 6100	Service Manual Supplement 1	CUC 2130M

Observe also the instructions given in the "Safety" Service Manual, part no. 72010 800 0000!

TV Set	Part Number	Kind of Manual	Chassis
ST63-755 DPL	72010 020 7000 72010 020 7100 72010 020 7300	Service Manual Supplement 1 Supplement 3	CUC 2040 N
ST63-782 NIC/TOP (VNM)	72010 020 7000 72010 020 7100 72010 020 7400 72010 020 7800 72010 020 7900	Service Manual Supplement 1 Supplement 4 Supplement 8 Supplement 9	CUC 2030 N
ST63-782 TOP (VNM)	72010 024 8000	Service Manual	CUC 2032
ST63-875 DPL/FT	72010 020 7000 72010 020 7100 72010 020 7300 72010 020 7400	Service Manual Supplement 1 Supplement 3 Supplement 4	CUC 2050 N
ST70-109 NIC/DOLBY (VNM)	72010 026 0000 72010 026 0300 72010 026 0400	Service Manual Supplement 3 Supplement 4	CUC 2030 N
ST70-200 IDTV	72010 021 1000 72010 021 1200 72010 021 1300 72010 021 1400	Service Manual Supplement 2 Supplement 3 Supplement 4	CUC 1836
ST70-209 (VNM)	72010 021 1000 72010 021 1200 72010 021 1400 72010 021 1900	Service Manual Supplement 2 Supplement 4 Supplement 9	CUC 1836
ST70-250 IDTV (VNM)	72010 026 9000	Service Manual	CUC 1836
ST70-260/8 IDTV (VNM)	72010 026 9000	Service Manual	CUC 1836
ST70-265/8 DOLBY (VNA)	72010 030 5000 72010 030 5400 72010 030 5500 72010 030 5600	Service Manual Supplement 4 Supplement 5 Supplement 6	CUC 1837
ST70-265/8 DOLBY (VNM)	72010 030 5000 72010 030 5100 72010 030 5200	Service Manual Supplement 1 Supplement 2	CUC 1837
ST70-265/8 DOLBY (VNX)	72010 030 5000 72010 030 5400 72010 030 5500 72010 030 5600	Service Manual Supplement 4 Supplement 5 Supplement 6	CUC 1837
ST70-270 IDTV	72010 021 1000 72010 021 1200 72010 021 1300 72010 021 1400	Service Manual Supplement 2 Supplement 3 Supplement 4	CUC 1836
ST70-270/8 IDTV	72010 021 1000 72010 021 1200 72010 021 1300 72010 021 1400	Service Manual Supplement 2 Supplement 3 Supplement 4	CUC 1836
ST70-278 IDTV	72010 019 3000 72010 019 3100 72010 019 3200 72010 019 3300 72010 019 3600	Service Manual Supplement 1 Supplement 2 Supplement 3 Supplement 6	CUC 1825
ST70-278 IDTV	72010 021 1000 72010 021 1200 72010 021 1300 72010 021 1400	Service Manual Supplement 2 Supplement 3 Supplement 4	CUC 1836
ST70-280 IDTV	72010 021 1000 72010 021 1200 72010 021 1300 72010 021 1400 72010 021 1700	Service Manual Supplement 2 Supplement 3 Supplement 4 Supplement 7	CUC 1836

Observe also the instructions given in the "Safety" Service Manual, part no. 72010 800 0000!

TV Set	Part Number	Kind of Manual	Chassis
ST70-280 IDTV	72010 021 1000	Service Manual	CUC 1836
	72010 021 1200	Supplement 2	
	72010 021 1300	Supplement 3	
	72010 021 1400	Supplement 4	
	72010 021 1700	Supplement 7	
ST70-282/8 (VNM)	72010 026 9000	Service Manual	CUC 1836
	72010 026 9100	Supplement 1	
ST70-282/8 (VNX)	72010 026 9000	Service Manual	CUC 1936
	72010 026 9000	Supplement 1	
	72010 026 9000	Supplement 3	
ST70-298 IDTV (VNM)	72010 026 9000	Service Manual	CUC 1836
	72010 026 9100	Supplement 1	
ST70-398 DOLBY (VNA)	72010 030 5000	Service Manual	CUC 1837
	72010 030 5400	Supplement 4	
	72010 030 5500	Supplement 5	
	72010 030 5600	Supplement 6	
ST70-398 DOLBY (VNM)	72010 030 5000	Service Manual	CUC 1837
	72010 030 5100	Supplement 1	
ST70-398 DOLBY (VNX)	72010 030 5000	Service Manual	CUC 1837
	72010 030 5400	Supplement 4	
	72010 030 5500	Supplement 5	
	72010 030 5600	Supplement 6	
ST70-5109/8 DOLBY (VNA)	72010 041 6000	Service Manual	CUC 2130M
	72010 041 6200	Supplement 2	
ST70-5109/8 DOLBY (VNG)	72010 041 6000	Service Manual	CUC 2130M
	72010 041 6200	Supplement 2	
ST70-5109/8 DOLBY (VNM)	72010 041 6000	Service Manual	CUC 2130M
	72010 041 6200	Supplement 2	
ST70-5109/8 DOLBY (VNX)	72010 041 6000	Service Manual	CUC 2130M
	72010 041 6200	Supplement 2	
ST70-600 TEXT	72010 020 7000	Service Manual	CUC 2030
	72010 020 7100	Supplement 1	
	72010 020 7300	Supplement 3	
ST70-602 NIC/TOP (VNM)	72010 026 0000	Service Manual	CUC 2030N
ST70-602 NIC/TOP (VNM)	72010 026 0000	Service Manual	CUC 2030 N
ST70-700 A NIC/FT (VNM)	72010 020 7000	Service Manual	CUC 2030 N
	72010 020 7100	Supplement 1	
	72010 020 7400	Supplement 4	
	72010 020 7800	Supplement 8	
	72010 020 7900	Supplement 9	
ST70-700 S/GB/DOLBY (VNM,VNA)	72010 026 0000	Service Manual	CUC 2030 N
	72010 026 0300	Supplement 3	
	72010 026 0400	Supplement 4	
ST70-701 NIC/TOP (VNM)	72010 020 7000	Service Manual	CUC 2030 N
	72010 020 7100	Supplement 1	
	72010 020 7400	Supplement 4	
	72010 020 7800	Supplement 8	
	72010 020 7900	Supplement 9	
ST70-7010 NIC/DOLBY (VNM)	72010 026 0300	Service Manual	CUC 2030 N
	72010 026 0000	Supplement 3	
ST70-702 NIC/TOP (VNM)	72010 020 7000	Service Manual	CUC 2030 N
	72010 020 7100	Supplement 1	
	72010 020 7400	Supplement 4	
	72010 020 7800	Supplement 8	
	72010 020 7900	Supplement 9	
ST70-702 TOP (VNM)	72010 024 8000	Service Manual	CUC 2032
ST70-702 TOP/TR (VNM)	72010 024 8000	Service Manual	CUC 2032
ST70-703 NIC/TOP (VNM)	72010 026 0000	Service Manual	CUC 2030N

Observe also the instructions given in the "Safety" Service Manual, part no. 72010 800 0000!

TV Set	Part Number	Kind of Manual	Chassis
ST70-703 NIC/TOP (VNM)	72010 026 0000	Service Manual	CUC 2030 N
ST70-705 FR TITANE (VNM)	72010 020 8000	Service Manual	CUC 2035 F
	72010 020 8200	Supplement 2	
	72010 020 8600	Supplement 6	
ST70-705 FR/TOP (VNM)	72010 020 8000	Service Manual	CUC 2035 F
	72010 020 8200	Supplement 2	
	72010 020 8300	Supplement 3	
	72010 020 8500	Supplement 5	
ST70-705 NIC/TEXT	72010 020 7000	Service Manual	CUC 2030 N
	72010 020 7100	Supplement 1	
	72010 020 7300	Supplement 3	
	72010 020 7400	Supplement 4	
ST70-706 NIC/TOP (VNM)	72010 020 7000	Service Manual	CUC 2030 N
	72010 020 7100	Supplement 1	
	72010 020 7400	Supplement 4	
	72010 020 7800	Supplement 8	
	72010 020 7900	Supplement 9	
ST70-707 NIC/FT (VNM)	72010 026 0000	Service Manual	CUC 2030N
	72010 026 0100	Supplement 1	
ST70-708 GB/DOLBY (VNM)	72010 026 0000	Service Manual	CUC 2030 N
	72010 026 0300	Supplement 3	
	72010 026 0400	Supplement 4	
ST70-712 NIC/TOP (VNM)	72010 020 7000	Service Manual	CUC 2030 N
	72010 020 7100	Supplement 1	
	72010 020 7400	Supplement 4	
	72010 020 7800	Supplement 8	
	72010 020 7900	Supplement 9	
ST70-712/5 NIC/TOP (VNM)	72010 020 7000	Service Manual	CUC 2030 N
	72010 020 7100	Supplement 1	
	72010 020 7400	Supplement 4	
	72010 020 7800	Supplement 8	
	72010 020 7900	Supplement 9	
ST70-713/8 DOLBY (VNA)	72010 041 6000	Service Manual	CUC 2130M
	72010 041 6200	Supplement 2	
ST70-713/8 DOLBY (VNM)	72010 041 6000	Service Manual	CUC 2130M
	72010 041 6100	Supplement 1	
ST70-715 NIC/TOP	72010 020 7000	Service Manual	CUC 2030 N
	72010 020 7100	Supplement 1	
	72010 020 7300	Supplement 3	
ST70-730 NIC/TOP (VNM)	72010 020 7000	Service Manual	CUC 2030 N
	72010 020 7100	Supplement 1	
	72010 020 7400	Supplement 4	
	72010 020 7800	Supplement 8	
	72010 020 7900	Supplement 9	
ST70-740NIC/DOLBY (VNM)	72010 026 0000	Service Manual	CUC 2030 N
	72010 026 0300	Supplement 3	
	72010 026 0400	Supplement 4	
ST70-741/8 DOLBY (VNA)	72010 041 6000	Service Manual	CUC 2130M
	72010 041 6200	Supplement 2	
ST70-741/8 DOLBY (VNM)	72010 041 6000	Service Manual	CUC 2130M
	72010 041 6100	Supplement 1	
ST70-742 PIP/DOLBY (VNM)	72010 026 0000	Service Manual	CUC 2050
	72010 026 0300	Supplement 3	
	72010 026 0400	Supplement 4	
ST70-743 PIP/DOLBY (VNA)	72010 043 1000	Service Manual	CUC 2060
	72010 043 1100	Supplement 1	
ST70-743 PIP/DOLBY (VNM)	72010 043 1000	Service Manual	CUC 2060

Observe also the instructions given in the "Safety" Service Manual, part no. 72010 800 0000!

TV Set	Part Number	Kind of Manual	Chassis
ST70-755 DPL	72010 020 7000 72010 020 7100 72010 020 7300	Service Manual Supplement 1 Supplement 3	CUC 2040 N
ST70-782 DOLBY (VNM)	72010 024 8000 72010 024 8400	Service Manual Supplement 4	CUC 2032
ST70-782 NIC/DOLBY (VNM)	72010 026 0000 72010 026 0300 72010 026 0400	Service Manual Supplement 3 Supplement 4	CUC 2030 N
ST70-782 NIC/TOP (VNM)	72010 020 7000 72010 020 7100 72010 020 7400 72010 020 7800 72010 020 7900	Service Manual Supplement 1 Supplement 4 Supplement 8 Supplement 9	CUC 2030 N
ST70-782 TOP (VNM)	72010 024 8000	Service Manual	CUC 2032
ST70-788	72010 020 7000 72010 020 7100 72010 020 7300	Service Manual Supplement 1 Supplement 3	CUC 2030
ST70-788 A (VNM)	72010 024 8000 72010 024 8100	Service Manual Supplement 1	CUC 2032
ST70-789 NIC/DOLBY (VNM)	72010 024 8000 72010 024 8200	Service Manual Supplement 2	CUC 2032 N
ST70-798 A TEXT (VNM)	72010 024 8000 72010 024 8100	Service Manual Supplement 1	CUC 2032
ST70-798 TEXT	72010 020 7000 72010 020 7100 72010 020 7300	Service Manual Supplement 1 Supplement 3	CUC 2030
ST70-802 FR/Dolby (VNM)	72010 028 6000	Service Manual	CUC 2035F
ST70-810 DPL	72010 020 7000 72010 020 7100 72010 020 7300 72010 020 7400	Service Manual Supplement 1 Supplement 3 Supplement 4	CUC 2050 N
ST70-819 NIC/TOP	72010 020 7000 72010 020 7100 72010 020 7300 72010 020 7400	Service Manual Supplement 1 Supplement 3 Supplement 4	CUC 2050 N
ST70-820 TOP (VNM)	72010 024 8000	Service Manual	CUC 2032
ST70-822 DOLBY (VNM)	72010 024 8000 72010 024 8200	Service Manual Supplement 2	CUC 2032
ST70-822/4 Dplby (VNM)	72010 026 0000 72010 026 0200	Service Manual Supplement 2	CUC 2030N
ST70-829 NIC/Dolby (VNM)	72010 026 0000 72010 026 0200	Service Manual Supplement 2	CUC 2050N
ST70-839 NIC/DOLBY (VNM)	72010 026 0000 72010 026 0300 72010 026 0400	Service Manual Supplement 3 Supplement 4	CUC 2050 N
ST70-860 FR/TOP	72010 020 8000 72010 020 8200 72010 020 8300	Service Manual Supplement 2 Supplement 3	CUC 2030 F
ST70-869 A IDTV (VNM)	72010 026 9000	Service Manual	CUC 1836
ST70-869 IDTV	72010 021 1000 72010 021 1200 72010 021 1300 72010 021 1400 72010 021 1700	Service Manual Supplement 2 Supplement 3 Supplement 4 Supplement 7	CUC 1836
ST70-869 IDTV	72010 021 1000 72010 021 1200 72010 021 1300 72010 021 1400 72010 021 1700	Service Manual Supplement 2 Supplement 3 Supplement 4 Supplement 7	CUC 1836

Observe also the instructions given in the "Safety" Service Manual, part no. 72010 800 0000!

TV Set	Part Number	Kind of Manual	Chassis
ST70-875 DPL/FT	72010 020 7000	Service Manual	CUC 2050 N
	72010 020 7100	Supplement 1	
	72010 020 7300	Supplement 3	
	72010 020 7400	Supplement 4	
ST70-898 NIC/DOLBY (VNM)	72010 024 8000	Service Manual	CUC 2032 N
	72010 024 8200	Supplement 2	
ST70-898(8A SOLBY (VNM)	72010 041 6000	Service Manual	CUC 2130M
	72010 041 6100	Supplement 1	
ST70-898/8A DOLBY (VNA)	72010 041 6000	Service Manual	CUC 2130M
	72010 041 6200	Supplement 2	
ST70-929 DOLBY (VNM)	72010 041 6000	Service Manual	CUC 2130
	72010 041 6200	Supplement 2	
	72010 041 6300	Supplement 3	
ST70-969 DOLBY (VNM)	72010 030 5000	Service Manual	CUC 1837
	72010 030 5400	Supplement 4	
	72010 030 5500	Supplement 5	
ST72-600 TOP (VNM)	72010 024 8000	Service Manual	CUC 2033
ST72-700 TOP	72010 020 7000	Service Manual	CUC 2051 N
	72010 020 7100	Supplement 1	
	72010 020 7300	Supplement 3	
	72010 020 7400	Supplement 4	
ST72-862 TOP (VNM)	72010 024 8000	Service Manual	CUC 2033
ST72-864 DOLBY (VNM)	72010 024 8000	Service Manual	CUC 2033
	72010 024 8200	Supplement 2	
ST72-864 FR/Dolby (VNM)	72010 028 6000	Service Manual	CUC 2033F
ST72-870 FR/TOP (VNM)	72010 020 8000	Service Manual	CUC 2031 F
	72010 020 8200	Supplement 2	
	72010 020 8300	Supplement 3	
	72010 020 8500	Supplement 5	
ST84-2202 FR/DOLBY (VNM)	72010 044 1000	Service Manual	CUC 2062 F
ST84-2202 NIC/DOLBY (VNM)	72010 043 1000	Service Manual	CUC 2062 N
	72010 043 1100	Supplement 1	
ST84-8910 NIC/DOLBY (VNM)	72010 026 0300	Service Manual	CUC 2080 N
	72010 026 0000	Supplement 3	
ST84-896 FR / TOP	72010 020 8000	Service Manual	CUC2080 F
	72010 020 8200	Supplement 2	
ST84-896 NIC/TOP	72010 020 7000	Service Manual	CUC 2080 N
	72010 020 7100	Supplement 1	
	72010 020 7300	Supplement 3	
	72010 020 7400	Supplement 4	
ST84-896 NIC/TOP (VNA)	72010 026 0000	Service Manual	CUC 2080N
ST84-896 NIC/TOP (VNA)	72010 026 0000	Service Manual	CUC 2080 N
ST84-899 Dolby (VNM)	72010 026 0000	Service Manual	CUC 2080
	72010 026 0200	Supplement 2	
ST84-899 FR/Dolby (VNM)	72010 020 8000	Service Manual	CUC 2080F
	72010 020 8200	Supplement 2	
	72010 020 8400	Supplement 4	
	72010 020 8700	Supplement 7	
	72010 020 8800	Supplement 8	
STATUS VISION MFW82-720/9 DVD/GB (VNM)	72010 024 9000	Service Manual	CUC 1931
	72010 024 9200	Supplement 2	
	72010 024 9400	Supplement 4	
	72010 024 9800	Supplement 8	
SYDNEY 100 SE7020 IDTV/LOG	72010 021 1000	Service Manual	CUC 1836
	72010 021 1200	Supplement 2	
	72010 021 1300	Supplement 3	
	72010 021 1400	Supplement 4	

Observe also the instructions given in the "Safety" Service Manual, part no. 72010 800 0000!

TV Set	Part Number	Kind of Manual	Chassis
SYDNEY 100 SE7021 IDTV/PIP	72010 021 1000	Service Manual	CUC 1836
	72010 021 1200	Supplement 2	
	72010 021 1300	Supplement 3	
	72010 021 1400	Supplement 4	
SYDNEY 100/8 SE7020 IDTV/LOG	72010 021 1000	Service Manual	CUC 1836
	72010 021 1200	Supplement 2	
	72010 021 1300	Supplement 3	
	72010 021 1400	Supplement 4	
SYDNEY 2000 SE7230 DOLBY (VNM)	72010 024 9000	Service Manual	CUC 1832
	72010 024 9400	Supplement 4	
SYDNEY FLAT SE7241 DOLBY (VNM)	72010 030 5000	Service Manual	CUC 1938
	72010 030 5400	Supplement 4	
	72010 030 5500	Supplement 5	
	72010 030 5700	Supplement 7	
SYDNEY SE7230 DOLBY (VNG)	72010 024 9000	Service Manual	CUC 1832
	72010 024 9300	Supplement 3	
	72010 024 9400	Supplement 4	
	72010 024 9700	Supplement 7	
SYDNEY SE7230 DOLBY (VNM)	72010 024 9000	Service Manual	CUC 1832
SYDNEY SE7230 DOLBY (VNX)	72010 024 9000	Service Manual	CUC 1832
	72010 024 9300	Supplement 3	
SYDNEY SE7230/8 DOLBY (VNA)	72010 024 9000	Service Manual	CUC 1832
	72010 024 9300	Supplement 3	
SYDNEY SE7230/8 DOLBY (VNM)	72010 024 9000	Service Manual	CUC 1832
	72010 024 9300	Supplement 3	
SYDNEY SE7230/8 DOLBY (VNX)	72010 024 9000	Service Manual	CUC 1832
	72010 024 9300	Supplement 3	
	72010 024 9400	Supplement 4	
	72010 024 9700	Supplement 7	
SYDNEY SE7240 DOLBY (VNA)	72010 030 5000	Service Manual	CUC 1838
	72010 030 5400	Supplement 4	
	72010 030 5500	Supplement 5	
	72010 030 5600	Supplement 6	
SYDNEY SE7240 DOLBY (VNM)	72010 030 5000	Service Manual	CUC 1838
	72010 030 5100	Supplement 1	
T51-071 (VNX)	72010 026 1000	Service Manual	CUC 7303
T51-071 TR (VNA)	72010 026 1000	Service Manual	CUC 7303
T51-071 TR (VNM)	72010 019 4000	Service Manual	CUC 7303
	72010 019 4600	Supplement 6	
	72010 021 9100	Supplement 11	
T51-1201/5 TOP	72010 044 4000	Service Manual	12.6
T51-3035 TEXT (VNX)	72010 026 1000	Service Manual	CUC 7303
T51-3050 text (VNM)	72010 026 1000	Service Manual	CUC 7303 with PLL
	72010 026 1100	Supplement 1	
	72010 026 1200	Supplement 2	
T51-720 TEXT (VNX)	72010 026 1000	Service Manual	CUC 7303
T51-731 TEXT (VNX)	72010 026 1000	Service Manual	CUC 7303
T51-731 TEXT/TR (VNA)	72010 026 1000	Service Manual	CUC 7303
T51-731 TEXT/TR (VNM)	72010 019 4000	Service Manual	CUC 7303
	72010 019 4600	Supplement 6	
	72010 021 9100	Supplement 11	
T51-732/4 TEXT (VNA)	72010 026 1000	Service Manual	CUC 7303
T51-830 MULTI/ICN	72010 024 0000	Service Manual	CUC 2003 H
	72010 024 0100	Supplement 1	
T51-830 MULTI/ICN (VNM)	72010 024 0000	Service Manual	CUC 2003 H
	72010 024 0100	Supplement 1	

Observe also the instructions given in the "Safety" Service Manual, part no. 72010 800 0000!

TV Set	Part Number	Kind of Manual	Chassis
T51-830 text (VNM)	72010 026 1000 72010 026 1100 72010 026 1200	Service Manual Supplement 1 Supplement 2	CUC 7303 with PLL
T51-830 text/TR (VNM)	72010 026 1000 72010 026 1100 72010 026 1200	Service Manual Supplement 1 Supplement 2	CUC 7303 with PLL
T51-830/12 TEXT (VNM)	72010 028 9000	Service Manual	CUC 7305
T51-830/4 text (VNM)	72010 026 1000 72010 026 1100 72010 026 1200	Service Manual Supplement 1 Supplement 2	CUC 7303 with PLL
T55-1201/5 TOP	72010 044 4000	Service Manual	12.6
T55-3035 TEXT (VNX)	72010 026 1000	Service Manual	CUC 7303
T55-3050 text (VNM)	72010 026 1000 72010 026 1100 72010 026 1200	Service Manual Supplement 1 Supplement 2	CUC 7303 with PLL
T55-600 text (VNM)	72010 026 1000 72010 026 1100 72010 026 1200	Service Manual Supplement 1 Supplement 2	CUC 7303 with PLL
T55-805 TEXT/TR (VNM)	72010 026 1000 72010 026 1100 72010 026 1300	Service Manual Supplement 1 Supplement 3	CUC 7303
T55-830 FT/GB	72010 019 4000 72010 019 4600 72010 019 4700	Service Manual Supplement 6 Supplement 7	CUC 7303
T55-830 FT/GB (VNA)	72010 026 1000 72010 026 1100 72010 026 1300	Service Manual Supplement 1 Supplement 3	CUC 7303
T55-830 FT/IR	72010 019 4000 72010 019 4600 72010 019 4700	Service Manual Supplement 6 Supplement 7	CUC 7303
T55-830 FT/IR (VNA)	72010 026 1000 72010 026 1100 72010 026 1200	Service Manual Supplement 1 Supplement 2	CUC 7303 with PLL
T55-830 MULTI MEGASIS	72010 024 0000 72010 024 0100	Service Manual Supplement 1	CUC 2003 H
T55-830 MULTI MEGASIS (VNM)	72010 024 0000 72010 024 0100	Service Manual Supplement 1	CUC 2003 H
T55-830 MULTI/COM (VNM)	72010 024 0000 72010 024 0100 72010 024 0200	Service Manual Supplement 1 Supplement 2	CUC 2003 H
T55-830 MULTI/ICN	72010 024 0000	Service Manual	CUC 2003 H
T55-830 MULTI/ICN (VNM)	72010 024 0000 72010 024 0100	Service Manual Supplement 1	CUC 2003 H
T55-830 TEXT (VNA)	72010 026 1000	Service Manual	CUC 7303
T55-830 TEXT/TR (VNA)	72010 026 1000	Service Manual	CUC 7303
T55-830 TEXT/TR (VNM)	72010 019 4000 72010 019 4600 72010 021 9100	Service Manual Supplement 6 Supplement 11	CUC 7303
T55-830/ TEXT	72010 019 4000 72010 019 4600 72010 019 4700	Service Manual Supplement 6 Supplement 7	CUC 7303
T55-830/4 TEXT	72010 019 4000 72010 019 4600 72010 019 4700	Service Manual Supplement 6 Supplement 7	CUC 7303
T55-830/4 TEXT (VNA)	72010 026 1000	Service Manual	CUC 7303
T55-837 TEXT (VNA)	72010 026 1000 72010 026 1100 72010 026 1300	Service Manual Supplement 1 Supplement 3	CUC 7303

Observe also the instructions given in the "Safety" Service Manual, part no. 72010 800 0000!

TV Set	Part Number	Kind of Manual	Chassis
T55-837 text (VNA)	72010 026 1000 72010 026 1100	Service Manual Supplement 1	CUC 7303
T55-837 TEXT (VNM)	72010 019 4000 72010 019 4600 72010 021 9000	Service Manual Supplement 6 Supplement 10	CUC 7303
T55-838 text (VNA)	72010 026 1000 72010 026 1100	Service Manual Supplement 1	CUC 7303
T55-838 TEXT (VNM)	72010 019 4000 72010 019 4600 72010 021 9000	Service Manual Supplement 6 Supplement 10	CUC 7303
T55-840 TOP/SAT	72010 024 0000	Service Manual	CUC 2003
T55-840 TOP/SAT (VNM)	72010 024 0000 72010 024 0100	Service Manual Supplement 1	CUC 2003
T55-842 FR	72010 019 6000 72010 019 6300 72010 019 6400	Service Manual Supplement 3 Supplement 4	CUC 7303 FR
T55-843 FR MEGASIS	72010 018 5000 72010 018 5100	Service Manual Supplement 1	CUC 7301 F ASIS
T55-844 FR (VNA)	72010 025 7000	Service Manual	CUC 7303F
T55-844 FR (VNA)	72010 025 7000	Service Manual	CUC 7303 F
T55-847 FR / TEXT	72010 019 6000 72010 019 6300 72010 019 6400	Service Manual Supplement 3 Supplement 4	CUC 7303 FR
T55-848 FR Text (VNA)	72010 025 7000	Service Manual	CUC 7303F
T55-848 FR TEXT (VNA)	72010 025 7000	Service Manual	CUC 7303 F
T55-930 FT/GB (VNA)	72010 026 1000 72010 026 1100 72010 026 1300	Service Manual Supplement 1 Supplement 3	CUC 7303
T55-930 FT/IR	72010 026 1000 72010 026 1100 72010 026 1200	Service Manual Supplement 1 Supplement 2	CUC 7303 with PLL
THARUS 38 LCD 38-9210 TOP	Central Repair		
TORONTO SE7215 (VNM)	72010 026 9000 72010 026 9100	Service Manual Supplement 1	CUC 1830
TORONTO SE7215/8 (VNM)	72010 026 9000 72010 026 9100	Service Manual Supplement 1	CUC 1830
TORONTO SE7216 DOLBY (VNA)	72010 030 5000 72010 030 5400 72010 030 5500 72010 030 5600	Service Manual Supplement 4 Supplement 5 Supplement 6	CUC 1838
TORONTO SE7216 DOLBY (VNM)	72010 030 5000 72010 030 5100	Service Manual Supplement 1	CUC 1838
TORONTO SE7216/8 DOLBY (VNA)	72010 030 5000 72010 030 5400 72010 030 5500 72010 030 5600	Service Manual Supplement 4 Supplement 5 Supplement 6	CUC 1838
TORONTO SE7216/8 DOLBY (VNM)	72010 030 5000 72010 030 5100	Service Manual Supplement 1	CUC 1838
WIEN 100 SE6320 IDTV/LOG	72010 021 1000 72010 021 1200 72010 021 1300 72010 021 1400	Service Manual Supplement 2 Supplement 3 Supplement 4	CUC 1836
WIEN SE 6340 DOLBY (VNA)	72010 030 5000 72010 030 5400 72010 030 5500 72010 030 5600	Service Manual Supplement 4 Supplement 5 Supplement 6	CUC 1837

Observe also the instructions given in the "Safety" Service Manual, part no. 72010 800 0000!

TV Set	Part Number	Kind of Manual	Chassis
WIEN SE6340 DOLBY (VNM)	72010 030 5000 72010 030 5100	Service Manual Supplement 1	CUC 1837
WT 2	Exchange Set		
WT-AV 1	Central Repair		
XENTIA 55 FLAT MF55-5101 FR/DOLBY (VNM)	72010 028 6000 72010 028 6100 72010 028 6200	Service Manual Supplement 1 Supplement 2	CUC 2036 F
XENTIA 55 FLAT MF55-5101 NIC/DOLBY (VNM)	72010 024 8000 72010 024 8400 72010 024 8500	Service Manual Supplement 4 Supplement 5	CUC 2036 N
XENTIA 55 FLAT MF55-5201/8 DOLBY (VNA)	72010 041 6000 72010 041 6200	Service Manual Supplement 2	CUC 2136M
XENTIA 55 FLAT MF55-5201/8 DOLBY (VNG)	72010 041 6000 72010 041 6200	Service Manual Supplement 2	CUC 2136M
XENTIA 55 FLAT MF55-5201/8 DOLBY (VNM)	72010 041 6000 72010 041 6200	Service Manual Supplement 2	CUC 2136M
XENTIA 55 FLAT MF55-5201/8 DOLBY (VNX)	72010 041 6000 72010 041 6200	Service Manual Supplement 2	CUC 2136M
XENTIA 55 M55-420/8 DOLBY (VNA)	72010 030 5000 72010 030 5400 72010 030 5500 72010 030 5600	Service Manual Supplement 4 Supplement 5 Supplement 6	CUC 1807
XENTIA 55 M55-420/8 DOLBY (VNM)	72010 030 5000 72010 030 5100	Service Manual Supplement 1	CUC 1807
XENTIA 55 ST55-400 Dolby (VNM)	72010 024 7000 72010 024 7300	Service Manual Supplement 3	CUC 2021
XENTIA 55 ST55-400 FR/DOLBY (VNM)	72010 027 2000 72010 027 2100	Service Manual Supplement 1	CUC 2021 F
XENTIA 55 ST55-400 NIC/Dolby (VNM)	72010 024 7000 72010 024 7300	Service Manual Supplement 3	CUC 2021N
XENTIA 55 ST55-405 DOLBY (VNA)	72010 040 7000 72010 040 7400	Service Manual Supplement 4	CUC 2121
XENTIA 55 ST55-405 DOLBY (VNM)	72010 040 7000	Service Manual	CUC 2121
XENTIA 55 ST55-405/8 DOLBY (VNA)	72010 040 7000 72010 040 7500	Service Manual Supplement 5	CUC 2121 M
XENTIA 55 ST55-405/8 DOLBY (VNM)	72010 040 7000	Service Manual	CUC 2121 M
XENTIA 55 ST55-405/8 DOLBY (VNX)	72010 040 7000 72010 040 7400	Service Manual Supplement 4	CUC 2121M
XENTIA 63 M63-400/8 (VNM)	72010 026 9000	Service Manual	CUC 1836
XENTIA 63 M63-420/8 DOLBY (VNA)	72010 030 5000 72010 030 5400 72010 030 5500 72010 030 5600	Service Manual Supplement 4 Supplement 5 Supplement 6	CUC 1837
XENTIA 63 M63-420/8 DOLBY (VNM)	72010 030 5000 72010 030 5100	Service Manual Supplement 1	CUC 1837
XENTIA 63 M63-420/8 DOLBY (VNX)	72010 030 5000 72010 030 5400 72010 030 5500 72010 030 5600	Service Manual Supplement 4 Supplement 5 Supplement 6	CUC 1837
XENTIA 63 ST63-400/4 DOLBY (VNM)	72010 026 0000 72010 026 0200	Service Manual Supplement 2	CUC 2030N
XENTIA 63 ST63-4101/8 DOLBY (VNA)	72010 041 6000 72010 041 6200	Service Manual Supplement 2	CUC 2130M
XENTIA 63 ST63-4101/8 DOLBY (VNM)	72010 041 6000 72010 041 6100	Service Manual Supplement 1	CUC 2130M

Observe also the instructions given in the "Safety" Service Manual, part no. 72010 800 0000!

TV Set	Part Number	Kind of Manual	Chassis
XENTIA 70 FLAT MFW70-430/8 DOLBY (VNA)	72010 030 5000	Service Manual	CUC 1934
	72010 030 5400	Supplement 4	
	72010 030 5500	Supplement 5	
	72010 030 5600	Supplement 6	
XENTIA 70 FLAT MFW70-430/8 DOLBY (VNM)	72010 030 5000	Service Manual	CUC 1934
	72010 030 5100	Supplement 1	
XENTIA 70 FLAT MFW70-490/8 GB/DOLBY (VNM)	72010 024 9000	Service Manual	CUC 1930
	72010 024 9200	Supplement 2	
	72010 024 9400	Supplement 4	
	72010 024 9800	Supplement 8	
XENTIA 70 FLAT MFW82-490/9 DOLBY (VNM)	72010 024 9000	Service Manual	CUC 1930
	72010 024 9400	Supplement 4	
XENTIA 72 FLAT MF72-430 DOLBY (VNA)	72010 030 5000	Service Manual	CUC 1838
	72010 030 5400	Supplement 4	
	72010 030 5500	Supplement 5	
	72010 030 5600	Supplement 6	
XENTIA 72 FLAT MF72-430 DOLBY (VNM)	72010 030 5000	Service Manual	CUC 1838
	72010 030 5100	Supplement 1	
	72010 030 5200	Supplement 2	
XENTIA 72 FLAT MF72-430 DOLBY (VNX)	72010 030 5000	Service Manual	CUC 1838
	72010 030 5400	Supplement 4	
	72010 030 5500	Supplement 5	
	72010 030 5600	Supplement 6	
XENTIA 72 FLAT MF72-430/8 DOLBY (VNA)	72010 030 5000	Service Manual	CUC 1838
	72010 030 5400	Supplement 4	
	72010 030 5500	Supplement 5	
	72010 030 5600	Supplement 6	
XENTIA 72 FLAT MF72-430/8 DOLBY (VNM)	72010 030 5000	Service Manual	CUC 1838
	72010 030 5100	Supplement 1	
	72010 030 5200	Supplement 2	
XENTIA 72 FLAT MF72-430/8 DOLBY (VNX)	72010 030 5000	Service Manual	CUC 1838
	72010 030 5400	Supplement 4	
	72010 030 5500	Supplement 5	
	72010 030 5600	Supplement 6	
XENTIA 72 FLAT MF72-490 DOLBY (VNA)	72010 024 9000	Service Manual	CUC 1832
	72010 024 9100	Supplement 1	
	72010 024 9400	Supplement 4	
	72010 024 9600	Supplement 6	
XENTIA 72 FLAT MF72-490 DOLBY (VNM)	72010 024 9000	Service Manual	CUC 1832
	72010 024 9100	Supplement 1	
XENTIA 72 FLAT MF72-490/8 DOLBY (VNA)	72010 024 9000	Service Manual	CUC 1832
	72010 024 9100	Supplement 1	
	72010 024 9400	Supplement 4	
	72010 024 9600	Supplement 6	
XENTIA 72 FLAT MF72-490/8 DOLBY (VNM)	72010 024 9000	Service Manual	CUC 1832
	72010 024 9100	Supplement 1	
XENTIA 72 M72-400 DOLBY (VNM)	72010 024 9000	Service Manual	CUC 1832
	72010 024 9100	Supplement 1	
XENTIA 72 M72-400 DOLBY (VNX)	72010 024 9000	Service Manual	CUC 1832
	72010 024 9100	Supplement 1	
	72010 024 9400	Supplement 4	
	72010 024 9600	Supplement 6	
XENTIA 72 M72-400/8 DOLBY (VNM)	72010 024 9000	Service Manual	CUC 1832
	72010 024 9100	Supplement 1	
XENTIA 72 M72-400/8 DOLBY (VNX)	72010 024 9000	Service Manual	CUC 1832
	72010 024 9100	Supplement 1	
	72010 024 9400	Supplement 4	
	72010 024 9600	Supplement 6	

Observe also the instructions given in the "Safety" Service Manual, part no. 72010 800 0000!

TV Set	Part Number	Kind of Manual	Chassis
XENTIA 72 M72-420 DOLBY (VNA)	72010 030 5000	Service Manual	CUC 1838
	72010 030 5400	Supplement 4	
	72010 030 5500	Supplement 5	
	72010 030 5600	Supplement 6	
XENTIA 72 M72-420 DOLBY (VNM)	72010 030 5000	Service Manual	CUC 1838
	72010 030 5100	Supplement 1	
XENTIA 72 M72-420/8 DOLBY (VNA)	72010 030 5000	Service Manual	CUC 1838
	72010 030 5400	Supplement 4	
	72010 030 5500	Supplement 5	
	72010 030 5600	Supplement 6	
XENTIA 72 M72-420/8 DOLBY (VNM)	72010 030 5000	Service Manual	CUC 1838
	72010 030 5100	Supplement 1	
XENTIA 82 FLAT MFW 82-430/8 DOLBY (VNA)	72010 030 5000	Service Manual	CUC 1935
	72010 030 5400	Supplement 4	
	72010 030 5500	Supplement 5	
	72010 030 5600	Supplement 6	
XENTIA 82 FLAT MFW 82-430/8 DOLBY (VNG)	72010 030 5000	Service Manual	CUC 1935
	72010 030 5400	Supplement 4	
	72010 030 5500	Supplement 5	
	72010 030 5600	Supplement 6	
XENTIA 82 FLAT MFW 82-430/8 DOLBY (VNN)	72010 030 5000	Service Manual	CUC 1935
	72010 030 5400	Supplement 4	
	72010 030 5500	Supplement 5	
	72010 030 5600	Supplement 6	
XENTIA 82 FLAT MFW 82-430/8 DOLBY (VNR)	72010 030 5000	Service Manual	CUC 1935
	72010 030 5400	Supplement 4	
	72010 030 5500	Supplement 5	
	72010 030 5600	Supplement 6	
XENTIA 82 FLAT MFW 82-430/8 DOLBY (VNU)	72010 030 5000	Service Manual	CUC 1935
	72010 030 5400	Supplement 4	
	72010 030 5500	Supplement 5	
	72010 030 5600	Supplement 6	
XENTIA 82 FLAT MFW 82-430/8 DOLBY (VNX)	72010 030 5000	Service Manual	CUC 1935
	72010 030 5400	Supplement 4	
	72010 030 5500	Supplement 5	
	72010 030 5600	Supplement 6	
XENTIA 82 FLAT MFW82-430/8 DOLBY (VNM)	72010 030 5000	Service Manual	CUC 1935
	72010 030 5100	Supplement 1	
	72010 030 5200	Supplement 2	
XENTIA 82 FLAT MFW82-490/9 DOLBY (VNM)	72010 024 9000	Service Manual	CUC 1931
	72010 024 9400	Supplement 4	
XENTIA 82 FLAT MFW82-490/9 GB/DOLBY (VNM)	72010 024 9000	Service Manual	CUC 1931
	72010 024 9200	Supplement 2	
	72010 024 9400	Supplement 4	
	72010 024 9800	Supplement 8	

Observe also the instructions given in the "Safety" Service Manual, part no. 72010 800 0000!

Service Manuals sorted by Chassis

Chassis		Part Number	Kind of Manual
12.5		72010 043 3000 72010 043 3100 72010 043 3200	Service Manual Supplement 1 Supplement 2
12.5 F		72010 044 2000	Service Manual
12.6		72010 044 4000	Service Manual
12.6 F		72010 044 6000	Service Manual
CUC 1806	DIGI BASIC ++	72010 021 1000 72010 021 1200 72010 021 1400 72010 021 1600 72010 021 1900	Service Manual Supplement 2 Supplement 4 Supplement 6 Supplement 9
CUC 1807	DIGI 100	72010 030 5000 72010 030 5100 72010 030 5600 72010 030 5700	Service Manual Supplement 1 Supplement 6 Supplement 7
CUC 1825	DIGI BASIC	72010 019 3000 72010 019 3100 72010 019 3200 72010 019 3300 72010 019 3600	Service Manual Supplement 1 Supplement 2 Supplement 3 Supplement 6
CUC 1826	DIGI BASIC +	72010 019 3000 72010 019 3100 72010 019 3200 72010 019 3300 72010 019 3600	Service Manual Supplement 1 Supplement 2 Supplement 3 Supplement 6
CUC 1828	DIGI BASIC ++	72010 021 1000 72010 021 1200 72010 021 1400 72010 021 1600	Service Manual Supplement 2 Supplement 4 Supplement 6
CUC 1829	DIGI BASIC ++	72010 021 1000 72010 021 1200	Service Manual Supplement 2
CUC 1830	DIGI BASIC ++	72010 021 1000 72010 021 1200 72010 021 1400 72010 021 1600 72010 021 1900	Service Manual Supplement 2 Supplement 4 Supplement 6 Supplement 9
CUC 1830 (from 3/2000 on)	DIGI BASIC ++	72010 026 9000 72010 026 9100 72010 026 9300	Service Manual Supplement 1 Supplement 3
CUC 1832	DIGI Basic 3	72010 024 9000 72010 024 9100 72010 024 9300 72010 024 9400 72010 024 9600 72010 024 9700	Service Manual Supplement 1 Supplement 3 Supplement 4 Supplement 6 Supplement 7
CUC 1836	DIGI BASIC ++	72010 021 1000 72010 021 1200 72010 021 1300 72010 021 1400 72010 021 1700 72010 021 1900	Service Manual Supplement 2 Supplement 3 Supplement 4 Supplement 7 Supplement 9
CUC 1836 (from 11/99 on)	DIGI BASIC ++	72010 026 9000 72010 026 9100 72010 026 9300	Service Manual Supplement 1 Supplement 3

TV

Observe also the instructions given in the "Safety" Service Manual, part no. 72010 800 0000!

Chassis		Part Number	Kind of Manual
CUC 1837	DIGI 100	72010 030 5000	Service Manual
		72010 030 5100	Supplement 1
		72010 030 5200	Supplement 2
		72010 030 5300	Supplement 3
		72010 030 5400	Supplement 4
		72010 030 5500	Supplement 5
CUC 1837 A	DIGI 100	72010 045 1000	Service Manual
CUC 1838	DIGI 100	72010 030 5000	Service Manual
		72010 030 5100	Supplement 1
		72010 030 5200	Supplement 2
		72010 030 5300	Supplement 3
		72010 030 5400	Supplement 4
		72010 030 5500	Supplement 5
		72010 030 5600	Supplement 6
CUC 1839	DIGI 100	72010 030 5000	Service Manual
		72010 030 5100	Supplement 1
		72010 030 5400	Supplement 4
		72010 030 5600	Supplement 6
CUC 1929	DIGI BASIC ++	72010 021 1000	Service Manual
		72010 021 1200	Supplement 2
		72010 021 1300	Supplement 3
		72010 021 1400	Supplement 4
		72010 021 1700	Supplement 7
		72010 021 1800	Supplement 8
CUC 1929 (from 11/99 on)	DIGI BASIC ++	72010 026 9000	Service Manual
		72010 026 9100	Supplement 1
		72010 026 9300	Supplement 3
CUC 1930	DIGI Basic 3	72010 024 9000	Service Manual
		72010 024 9100	Supplement 1
		72010 024 9400	Supplement 4
		72010 024 9500	Supplement 5
		72010 024 9800	Supplement 8
CUC 1931	DIGI Basic 3	72010 024 9000	Service Manual
		72010 024 9100	Supplement 1
		72010 024 9200	Supplement 2
		72010 024 9300	Supplement 3
		72010 024 9400	Supplement 4
		72010 024 9500	Supplement 5
		72010 024 9700	Supplement 7
		72010 024 9800	Supplement 8
		72010 024 9900	Supplement 9
		72010 041 9100	Supplement 10
CUC 1934	DIGI 100	72010 030 5000	Service Manual
		72010 030 5100	Supplement 1
		72010 030 5200	Supplement 2
		72010 030 5300	Supplement 3
		72010 030 5400	Supplement 4
		72010 030 5500	Supplement 5
CUC 1935	DIGI 100	72010 030 5000	Service Manual
		72010 030 5100	Supplement 1
		72010 030 5200	Supplement 2
		72010 030 5300	Supplement 3
		72010 030 5400	Supplement 4
		72010 030 5500	Supplement 5
		72010 030 5600	Supplement 6
		72010 030 5700	Supplement 7

Observe also the instructions given in the "Safety" Service Manual, part no. 72010 800 0000!

Chassis		Part Number	Kind of Manual
CUC 1935	DIGI 100/AC3	72010 042 3000	Service Manual
		72010 042 3100	Supplement 1
CUC 1935 A	DIGI 100	72010 045 1000	Service Manual
CUC 1937	DIGI 100	72010 042 3000	Service Manual
CUC 1952	DIGI 6	72010 019 9000	Service Manual
		72010 019 9100	Supplement 1
		72010 019 9200	Supplement 2
		72010 019 9400	Supplement 4
CUC 1983	DIGI 6	72010 019 9000	Service Manual
		72010 019 9100	Supplement 1
		72010 019 9200	Supplement 2
		72010 019 9400	Supplement 4
		72010 019 9500	Supplement 5
CUC 1984	DIGI 6	72010 019 9000	Service Manual
		72010 019 9100	Supplement 1
		72010 019 9200	Supplement 2
		72010 019 9400	Supplement 4
CUC 2003		72010 024 0000	Service Manual
		72010 024 0100	Supplement 1
CUC 2003 H		72010 024 0000	Service Manual
		72010 024 0100	Supplement 1
		72010 024 0200	Supplement 2
CUC 2005		72010 026 2000	Service Manual
CUC 2020		72010 021 4000	Service Manual
CUC 2020 FR		72010 021 8000	Service Manual
		72010 021 8100	Supplement 1
CUC 2020 N		72010 021 4000	Service Manual
CUC 2021		72010 024 7000	Service Manual
		72010 024 7300	Supplement 3
CUC 2021 F		72010 027 2000	Service Manual
		72010 027 2100	Supplement 1
		72010 027 2200	Supplement 2
CUC 2021 N		72010 024 7000	Service Manual
		72010 024 7200	Supplement 2
		72010 024 7300	Supplement 3
		72010 024 7400	Supplement 4
CUC 2030		72010 020 7000	Service Manual
		72010 020 7100	Supplement 1
		72010 020 7300	Supplement 3
CUC 2030 F		72010 020 8000	Service Manual
		72010 020 8200	Supplement 2
		72010 020 8300	Supplement 3
CUC 2030 N		72010 020 7000	Service Manual
		72010 020 7100	Supplement 1
		72010 020 7300	Supplement 3
		72010 020 7400	Supplement 4
		72010 020 7900	Supplement 9
CUC 2030 N (from 11/99 on)		72010 026 0000	Service Manual
		72010 026 0100	Supplement 1
		72010 026 0200	Supplement 2
		72010 026 0300	Supplement 3
		72010 026 0400	Supplement 4
CUC 2032		72010 024 8000	Service Manual
		72010 024 8100	Supplement 1
		72010 024 8200	Supplement 2
		72010 024 8300	Supplement 3
		72010 024 8400	Supplement 4
CUC 2032 N		72010 024 8000	Service Manual
		72010 024 8200	Supplement 2

Observe also the instructions given in the "Safety" Service Manual, part no. 72010 800 0000!



Chassis		Part Number	Kind of Manual
CUC 2033		72010 024 8000 72010 024 8200	Service Manual Supplement 2
CUC 2033 F		72010 028 6000	Service Manual
CUC 2033 N		72010 024 8000 72010 024 8300	Service Manual Supplement 3
CUC 2035 F (from 11/99 on)		72010 028 6000 72010 028 6100	Service Manual Supplement 1
CUC 2036 F		72010 028 6000 72010 028 6100 72010 028 6200	Service Manual Supplement 1 Supplement 2
CUC 2036 N		72010 024 8000 72010 024 8400 72010 024 8500	Service Manual Supplement 4 Supplement 5
CUC 2040 India		72010 020 7000 72010 020 7100 72010 020 7300	Service Manual Supplement 1 Supplement 3
CUC 2040 N		72010 020 7000 72010 020 7100 72010 020 7300	Service Manual Supplement 1 Supplement 3
CUC 2050 N		72010 020 7000 72010 020 7100 72010 020 7300 72010 020 7400	Service Manual Supplement 1 Supplement 3 Supplement 4
CUC 2050 N (from 11/99 on)		72010 026 0000 72010 026 0100 72010 026 0200	Service Manual Supplement 1 Supplement 2
CUC 2051 N		72010 020 7000 72010 020 7100 72010 020 7300 72010 020 7400	Service Manual Supplement 1 Supplement 3 Supplement 4
CUC 2058 D		72010 025 9000 72010 025 9100 72010 025 9200	Service Manual Supplement 1 Supplement 2
CUC 2058 F		72010 020 8000 72010 020 8200 72010 020 8400 72010 020 8800	Service Manual Supplement 2 Supplement 4 Supplement 8
CUC 2058 N		72010 020 7000 72010 020 7100 72010 020 7300 72010 020 7400 72010 020 7800	Service Manual Supplement 1 Supplement 3 Supplement 4 Supplement 8
CUC 2058 N (from 11/99 on)		72010 026 0000 72010 026 0100 72010 026 0200 72010 026 0300	Service Manual Supplement 1 Supplement 2 Supplement 3
CUC 2059 D		72010 025 9000 72010 025 9100 72010 025 9200	Service Manual Supplement 1 Supplement 2
CUC 2059 F		72010 020 8000 72010 020 8200 72010 020 8300 72010 020 8400 72010 020 8800	Service Manual Supplement 2 Supplement 3 Supplement 4 Supplement 8
CUC 2059 N		72010 020 7000 72010 020 7100 72010 020 7300 72010 020 7400 72010 020 7800	Service Manual Supplement 1 Supplement 3 Supplement 4 Supplement 8

Observe also the instructions given in the "Safety" Service Manual, part no. 72010 800 0000!

Chassis	Part Number	Kind of Manual
CUC 2059 N (from 11/99 on)	72010 026 0000	Service Manual
	72010 026 0100	Supplement 1
	72010 026 0200	Supplement 2
	72010 026 0300	Supplement 3
CUC 2060	72010 043 1000	Service Manual
	72010 043 1100	Supplement 1
CUC 2060 F	72010 044 1000	Service Manual
CUC 2062 F	72010 044 1000	Service Manual
CUC 2062 N	72010 043 1000	Service Manual
	72010 043 1100	Supplement 1
CUC 2068 N	72010 043 1000	Service Manual
	72010 043 1100	Supplement 1
CUC 2069 F	72010 044 1000	Service Manual
CUC 2069 N	72010 043 1000	Service Manual
	72010 043 1100	Supplement 1
CUC 2080 F	72010 020 8000	Service Manual
	72010 020 8200	Supplement 2
	72010 020 8300	Supplement 3
	72010 020 8400	Supplement 4
	72010 020 8800	Supplement 8
CUC 2080 F	72010 020 8000	Service Manual
	72010 020 8200	Supplement 2
CUC 2080 N	72010 020 7000	Service Manual
	72010 020 7100	Supplement 1
	72010 020 7300	Supplement 3
	72010 020 7400	Supplement 4
CUC 2080 N (from 11/99 on)	72010 026 0000	Service Manual
	72010 026 0100	Supplement 1
	72010 026 0200	Supplement 2
	72010 026 0300	Supplement 3
CUC 2100	72010 040 7000	Service Manual
	72010 040 7100	Supplement 1
	72010 040 7200	Supplement 2
CUC 2103	72010 040 7000	Service Manual
	72010 040 7100	Supplement 1
	72010 040 7200	Supplement 2
	72010 040 7300	Supplement 3
	72010 040 7400	Supplement 4
CUC 2103 GB	72010 040 7000	Service Manual
	72010 040 7100	Supplement 1
	72010 040 7500	Supplement 5
CUC 2103 H	72010 043 6000	Service Manual
	72010 043 6100	Supplement 1
CUC 2103 M	72010 040 7000	Service Manual
CUC 2105	72010 040 7000	Service Manual
	72010 040 7300	Supplement 3
	72010 040 7400	Supplement 4
CUC 2121	72010 040 7000	Service Manual
	72010 040 7200	Supplement 2
	72010 040 7400	Supplement 4
	72010 040 7500	Supplement 5
	72010 040 7600	Supplement 6
CUC 2121 F	72010 041 1000	Service Manual
CUC 2121 GB	72010 040 7000	Service Manual
	72010 040 7100	Supplement 1
	72010 040 7400	Supplement 4

Observe also the instructions given in the "Safety" Service Manual, part no. 72010 800 0000!

Chassis		Part Number	Kind of Manual
CUC 2121 M		72010 040 7000	Service Manual
		72010 040 7200	Supplement 2
		72010 040 7300	Supplement 3
		72010 040 7400	Supplement 4
		72010 040 7600	Supplement 6
CUC 2130		72010 041 6000	Service Manual
		72010 041 6100	Supplement 1
		72010 041 6200	Supplement 2
CUC 2130 M		72010 041 6000	Service Manual
		72010 041 6100	Supplement 1
		72010 041 6200	Supplement 2
CUC 2131		72010 041 6000	Service Manual
		72010 041 6200	Supplement 2
CUC 2136		72010 041 6000	Service Manual
		72010 041 6100	Supplement 1
		72010 041 6200	Supplement 2
CUC 2136 M		72010 041 6000	Service Manual
		72010 041 6100	Supplement 1
		72010 041 6200	Supplement 2
CUC 7301 F ASIS		72010 018 5000	Service Manual
		72010 018 5100	Supplement 1
CUC 7303 F with PLL		72010 025 7000	Service Manual
CUC 7303 with PLL		72010 026 1000	Service Manual
		72010 026 1100	Supplement 1
		72010 026 1200	Supplement 2
		72010 026 1300	Supplement 3
CUC 7305		72010 019 5000	Service Manual
		72010 019 5100	Supplement 1
CUC 7305 with PLL		72010 028 9000	Service Manual
CUC 7350		72010 016 8000	Service Manual
		72010 016 8500	Supplement 5
		72010 016 8700	Supplement 7

Observe also the instructions given in the "Safety" Service Manual, part no. 72010 800 0000!

Contents: Video

Module Chart	3.2
– GV 819 bis GV 8450, KV 8..., SE 81	3.2
– GV 29, GV 94, GV 900 bis GV 9400, SE 91	3.2
– GV 10..., GV 30..., GV 50..., GV 60..., SE 11..., SE 12	3.3
– GV 31..., GV 51..., GV 61..., SE 13	3.3
– GV 32..., GV 52..., GV 62..., SE 14	3.4
– TVR37..., TVR51..., TVR55	3.4
– DVD Player GDV..., SE 1210	3.5
– DVD Player DVD Kit 1, GDP..., SE 1230, SE 1235	3.6
Headwheels and Head Cylinders	3.7
Service Manuals	3.9
– Video	3.9
– TVR Combinations	3.13
– DVD Player	3.14
Tele-Pilot® Remote Control Handsets/Overview	3.15
Video Remote Control Codes	3.18
Cancelling the Electronic Lock	3.20
Jigs and Tools	3.26
– Video Recorders	3.26
– TVR Combinations	3.28

To be better readable part numbers are shown with two spaces.
 For ordering spare parts please indicate part numbers as **twelve-figure number** without spaces.

Module Chart GV 819 to GV 8450, KV 8..., SE 81...

Designation	Part Number	GV 819 M	GV 8000 EURO	GV 8000 GB	GV 8000 SV/1	GV 8000 SV/2	GV 8000 SV/5	GV 8050 SV	GV 8300 EURO	GV 8300 SV	GV 8300 SV/5	GV 8400 EURO	GV 8400 GB	GV 8400 HiFi	GV 8400 HiFi/5	GV 8400 NIC 1	GV 8400 NIC 2	GV 8450 HiFi	KV 8001 VPS/5	KV 8301 VPS/5	KV 8401 HiFi/5	SE 8100 SV	SE 8105 HiFi	
		Tuner/Booster	75988 041 4400	●	●						●			●										
Tuner/Modulator	75988 041 4300			●	●				●	●				●									●	●
Tuner/Modulator	75988 041 4500			●									●											
Tuner/Modulator	75988 041 4800					●				●				●						●	●	●		
Tuner	75988 323 9500	●																						
RP 700	72011 713 0000			●	●	●	●	●		●	●	●	●	●	●	●	●	●	●	●	●	●	●	●
RP 700 FR	72011 713 0100		●						●															
RP 819	75988 323 9000	●																						

- 1) Evolution code AA
- 2) from evolution code AB on

Module Chart GV 29, GV 94, GV 900 to GV 9400, SE 91...

Designation	Part Number	GV 29 EURO	GV 29 VPS	GV 29 VPS/5	GV 94 HiFi	GV 94 NIC	GV 900 SV/1	GV 900 SV/2	GV 920 HiFi	GV 940 EURO	GV 940 HiFi	GV 940 HiFi/5	GV 940 NIC	GV 950 HiFi/NIC	GV 9000	GV 9000 SV	GV 9000 SV/5	GV 9300 EURO	GV 9300 SV	GV 9300 SV/5	GV 9400 EURO	GV 9400 HiFi	GV 9400 HiFi/5	GV 9400 NIC	SE 9100 SV	SE 9102 SV	SE 9105 HiFi	SE 9106 HiFi/NIC	
		Tuner	75988 046 4200						●	●	●	●	●	●	●	●									●	●	●	●	●
Tuner	75988 048 4400									●												●							
Tuner RF/TU/IF	75988 060 7200		●													●	●			●									
Tuner RF/TU/IF	75988 061 0500			●														●		●									
Tuner TU/IF	75988 062 0500	●																●											
Tuner RF/TU/IF	75988 062 4800				●	●																							
Socket Board	27599 002 8000															●	●				●					●			
Socket Board	27599 002 8100		●	●												●													
Socket Board	27599 002 8200	●																	●										
Socket Board	27599 002 8400				●	●																							
NICAM/Stereo Dec.	27599 006 0500										●	●	●	●								●	●	●	●				●
Stereo Decoder	27599 006 0600								●		●	●	●	●									●	●	●				●
Stereo Decoder TN-3	27599 006 0700				●																								
Stereo Decoder TN-6	27599 006 0800					●																							
TP 90 V	72011 713 1000		●	●	●	●	●	●	●	●	●	●	●	●	●	●	●	●	●	●	●	●	●	●	●	●	●	●	●
TP 90 V	72011 713 1100	●								●	●	●	●	●	●	●	●	●	●	●	●	●	●	●	●	●	●	●	●

Video

Module Chart GV 10..., GV 30..., GV 50..., GV 60..., SE 11..., SE 12...

Designation	Part Number	GV 1010 SV/1	GV 1030 HiFi	GV 3000 VPS/1	GV 3000 VPS/2	GV 3004 PDC/EURO	GV 3005 VPS	GV 3006 VPS	GV 3010 SV/1	GV 3010 SV/2	GV 3015 SV	GV 3042 NIC	GV 3043 HiFi	GV 3044 NIC/EURO	GV 3045 HiFi	GV 5052 NIC	GV 5053 HiFi	GV 5054 NIC/EURO	GV 6062 NIC	GV 6063 HiFi	GV 6065 HiFi	SE 1102 SV	SE 1105 HiFi	SE 1106 HiFi/NIC	SE 1200 SV	SE 1205 HiFi	SE 1206 HiFi/NIC
Tuner	75988 046 4200	●	●																			●	●				
Tuner	75988 048 4400																						●	●			
Tuner RF/TU/IF	75988 060 7200			●	●		●	●	●	●															●		
Tuner RF/TU/IF	75988 061 0500										●				●												
Tuner TU/IF	75988 062 0500					●								●				●									
Tuner RF/TU/IF	75988 062 4800											●	●			●	●		●	●	●					●	●
Socket Board TB-2	27599 002 9700											●	●	●	●	●	●	●								●	
Socket Board TB-2	27599 102 0000																		●	●	●						●
Featurebox DM-1	27599 006 1400																		●	●	●						●
NICAM/Stereo-Dec.	27599 006 0500																							●			
Stereo Decoder	27599 006 0600		●																					●			
TP 90 V	72011 713 1000	●	●	●	●		●	●	●	●	●	●	●		●	●	●					●	●	●	●	●	●
TP 90 V	72011 713 1100					●								●				●									
TP 91 V	72011 713 1400																		●	●	●						●

Video

Module Chart GV 31..., GV 51..., GV 61..., SE 13...

Designation	Part Number	GV 3100 VPS/1	GV 3100 VPS/2	GV 3105 VPS	GV 3106 VPS	GV 3110 SV/1	GV 3110 SV/2	GV 3115 SV	GV 3142 NIC	GV 3143 HiFi	GV 3145 HiFi	GV 3146 MULTI	GV 3147 HiFi	GV 5152 NIC	GV 5153 HiFi	GV 6162 NIC	GV 6163 HiFi	GV 6165 HiFi	GV 6167 HiFi	SE 1300 SV	SE 1305 HiFi
Tuner/Modulator	75988 077 0100	●	●	●	●	●	●													●	
Tuner/Modulator	75988 077 5700							●													
Tuner/Modulator	75988 077 6400											●									
Tuner/Modulator	75988 077 6500								●	●	●			●	●	●	●	●	●		●
Tuner/Modulator	75988 078 1600											●	●						●		
TP 92 V black	72011 713 1900	●	●	●	●	●	●		●	●				●	●					●	●
TP 92 V polar	72011 713 2000	●	●	●		●	●	●	●	●	●			●	●						●
TP 93 V black	72011 713 2100															●	●				
TP 93 V polar	72011 713 2200															●	●	●	●		

Module Chart GV 32..., GV 52..., GV 62..., SE 14...

Designation	Part Number	GV 3200 VPS	GV 3205 VPS	GV 3242 NIC/1	GV 3242 NIC/2	GV 3243 HiFi	GV 3245 HiFi	GV 3247 HiFi	GV 5253 HiFi	GV 6262 NIC	GV 6263 HiFi	GV 6265 HiFi	SE 1400 SV	SE 1405 HiFi/NIC
Tuner/Modulator	75988 078 4800	●											●	
Tuner/Modulator	75988 078 4900		●											
Tuner/Modulator	75988 078 5200			●	●	●	●	●	●	●	●	●		●
TP 92 V black	72011 713 1900			●	●	●			●		●		●	●
TP 92 V polar	72011 713 2000	●	●	●	●	●	●			●	●	●		

Module Chart TVR37..., TVR51..., TVR55...

Designation	Part Number	TVR 3705	TVR 3705 FR	TVR 3730 Text	TVR 3730 Text/FR	TVR 3730 Text/GB	TVR 3735 FR/TOP	TVR 3735/1 TOP	TVR 3735/2 TOP	TVR 3740 FR/TOP	TVR 3740 FT/GB	TVR 3740/1 TOP	TVR 3740/2 TOP	TVR 5100	TVR 5100 Text (BA)	TVR 5130 FR	TVR 5130 Text	TVR 5130 Text/GB	TVR 5530 Text	TVR 5530 Text/FR	TVR 5540 FR/TOP	TVR 5540 FT/GB	TVR 5540/1 TOP	TVR 5540/2 TOP	
Head Amplifier	27599 004 0700	●	●											●											
Head Amplifier	27599 004 0800																								
Head Amplifier	27599 004 2000				●										●	●				●					
Head Amplifier	27599 004 2100			●	●																				
Keyboard	27599 002 8300							●	●	●	●	●	●									●	●	●	●
Tuner	75988 019 9500	●	●																						
Tuner	75988 019 9600	●	●																						
Tuner	75988 021 2500													●											
Tuner (1702)	75988 025 3000			●	●	●										●	●	●	●	●	●				
Tuner	75988 025 6200														●	●	●	●	●						
Tuner	75988 050 0900			●	●	●													●	●					
Tuner	75988 053 0200						●	●	●	●	●	●	●									●	●	●	●
TP 870	29642 061 1300							●	●	●	●	●	●									●	●	●	●
TVP 762	75988 017 0600													●											
TVP 763	75988 019 9700	●	●	●	●	●									●	●	●	●							
TVP 860	72011 650 0400																		●	●					

Video

Module Chart DVD Player GDV..., SE 1210

Designation	Part Number	GDV Modul 1	GDV Modul 1	DVD Modul Arganio	GDV 100 D	GDV 100 D/002	GDV 110 D	GDV 120	GDV 120/02	GDV 130	GDV 130/2	GDV 130/4	GDV 200	SE 1210
Chassis Board	27599 010 7800									●				●
Chassis Board	27599 010 7900									1) 2)				3)
Digital Board	75988 042 8000				●									
DVD Monoboard	75988 042 8200	●												
DVD Monoboard	75988 048 0000		●	●			●						●	
Digital Board	75988 045 0000					●								
MPEG Board	27599 009 0600							●						
MPEG Board	27599 009 0700								●					
Drive	29638 256 1100	●												
Drive	75988 042 7600				●									
Drive	75988 045 4200												●	
Drive	75988 045 7000		●	●										
Drive	75988 056 0100									●	●	●		●
Drive	75988 056 6000									5)				
Drive	75988 067 0000							●						
Drive	75988 069 0000								●					
Drive Board	27599 006 0900							●						
Drive Board	27599 006 1000								●					
Keyboard	27599 020 0100									●	●	●		●
Keyboard	27599 020 0100									4)				
Keyboard	75988 045 0100					●								
Keyboard	75988 042 8500						●							
Front Board cpl.	75988 045 5800												●	
Power Supply	27599 003 2100							●	●					
Power Supply	27599 003 2200	●	●	●										●
Power Supply	75988 042 8100				●									
Power Supply	75988 045 4400												●	
Mains Switch Board	75988 065 7400							●	●					
AV Socket Board	75988 065 8600							●	●					
A/V-MUX Board	75988 045 4700												●	
A/V-MUX Board	75988 042 8200					●								
A/V-MUX Board	75988 042 9800	●												
Socket Board	27599 002 9300							●	●					
Head Phone Board	75988 065 6700							●	●					
RP 100 D	75988 042 7700				●	●	●							
TP 80 V	75988 045 5900												●	
TP 82 V	75988 065 0000							●	●					
TP 84 D	72011 713 1500									●	●	●		●

- 1) from Serial No. 015260105200**44404**x on
- 2) from Serial No. 015472405200**17294**x on
- 3) from Serial No. 015475605200**14350**x on
- 4) from Serial No. 015260105200**48456**x on
- 5) from Serial No. 015260105200**91368**x on

Video

Module Chart DVD Player DVD Kit 1, GDP..., SE 1230, SE 1235

Video

Designation	Part Number	DVD-Kit 1	GDP 2200	GDP 3100	GDP 3200	GDP 3205	GDP 3200/KIT710	GDP 3205/KIT710	GDP 4200	GDP 4204	GDP 5100	GDP 5100/1	GDP 5100/2	GDP 5102	GDP 5105	GDP 5120	GDP 6150/1	GDP 6150/2	GDP 6155	SE 1230	SE 1235	
		Digital Board	26729 051 0101																			
Digital Board	26729 062 0101										•	•	•	•								
Digital Board	26729 070 0101																				•	
Digital Board	26729 073 0101																					
Digital Board	26729 075 0101	•																				
Digital Board	26729 076 0101			•																		
Digital Board	26729 086 0101					•																
Digital Board	26729 087 0101														•							
Digital Board	26729 088 0101																				•	
Digital Board	26729 089 0101																		•			
Digital Board	26729 093 0101				•																	
Laser unit	75988 067 0800	1)									1)	1)	1)	1)		1)	1)	1)		1)		
Laser unit	75988 067 3300	2)	•								2)	2)	2)	2)	•	2)	2)	2)	•	2)	•	
Power Supply	26727 015 0101			•	•	•					•	•	•	•	•						•	•
Power Supply	26727 015 0001															•	•	•	•			
Adapter Board	29305 160 4100	•																				
TP 81 D silver	26728 012 0001				•		•	•	•	•												
TP 81 D black	26728 012 0201			•		•			•						•						•	
TP 83 D	26728 012 0101										•	•	•	•		•	•	•	•		•	
TP 2200	72011 713 2800		•																			
Central Repair			•				•	•	•	•												

1) only with drive KIT 310 LE
 2) only with drive KIT 510 LE

Headwheels and Head Cylinders

Type of VCR	Heads	Headwheel Part No.	Head Cylinder Part No.
GV 29 EURO	2	27599 005 3100	
GV 29 VPS	2	27599 005 3100	
GV 29 VPS/5	2	27599 005 3000	
GV 94 HiFi	6	27599 005 3800	
GV 94 NIC	6	27599 005 3800	
GV 900 SV/1	2	75988 046 0300	
GV 900 SV/2	2	75988 046 0300	
GV 920 HiFi	6	75988 046 4300	
GV 940 EURO	6	75988 046 5000	
GV 940 HiFi	6	75988 046 4300	
GV 940 HiFi/5	6	75988 046 4300	
GV 940 NIC	6	75988 046 4300	
GV 950 HiFi/NIC	6	75988 046 4300	
GV 1010 SV/1	2	75988 046 0300	
GV 1030 HiFi	6	75988 046 4300	
GV 3000 VPS/1	2	27599 005 3900	
GV 3000 VPS/2	2	27599 005 3900	
GV 3004 PDC/EURO	2	27599 005 3900	
GV 3005 VPS	2	27599 005 4000	
GV 3006 VPS	2	27599 005 3900	
GV 3010 SV/1	2	27599 005 3900	
GV 3010 SV/2	2	27599 005 3900	
GV 3015 SV	2	27599 005 4000	
GV 3042 NIC	6	27599 005 4200	
GV 3043 HiFi	6	27599 005 4200	
GV 3044 NIC/EURO	6	27599 005 4100	
GV 3045 HiFi	6	27599 005 4200	
GV 3100 VPS/1	2	27599 005 4300	
GV 3100 VPS/2	2	27599 005 4300	
GV 3105 VPS	2	27599 005 4400	
GV 3106 VPS	2	27599 005 4300	
GV 3110 SV/1	2	27599 005 4300	
GV 3110 SV/2	2	27599 005 4300	
GV 3115 SV	2	27599 005 4400	
GV 3142 NIC	6	27599 005 4500	
GV 3143 HiFi	6	27599 005 4500	
GV 3145 HiFi	6	27599 005 4500	
GV 3146 MULTI	6	27599 005 4600	
GV 3147 HiFi	6	27599 005 4500	
GV 3200 VPS	2	27599 005 4800	
GV 3205 VPS	2	27599 005 4900	
GV 3242 NIC/1	6	27599 005 4700	
GV 3242 NIC/2	6	27599 005 4700	
GV 3243 HiFi	6	27599 005 4700	
GV 3245 HiFi	6	27599 005 4700	
GV 3247 HiFi	6	27599 005 4700	
GV 5052 NIC	6	27599 005 4200	
GV 5053 HiFi	6	27599 005 4200	
GV 5054 NIC/EURO	6	27599 005 4100	
GV 5152 NIC	6	27599 005 4500	
GV 5153 HiFi	6	27599 005 4500	
GV 5253 HiFi	6	27599 005 4700	
GV 6062 NIC	6	27599 005 4200	
GV 6063 HiFi	6	27599 005 4200	
GV 6065 HiFi	6	27599 005 4200	
GV 6162 NIC	6	27599 005 4500	
GV 6163 HiFi	6	27599 005 4500	
GV 6165 HiFi	6	27599 005 4500	

Headwheels and Head Cylinders

Type of VCR	Heads	Headwheel Part No.	Head Cylinder Part No.
GV 6167 HiFi	6	27599 005 4500	
GV 6262 NIC	6	27599 005 4700	
GV 6263 HiFi	6	27599 005 4700	
GV 6265 HiFi	6	27599 005 4700	
GV 819 M	2	75988 323 7000	75988 323 9400
GV 8000 EURO, GV 8000 SV/1	2	27599 005 2200	75988 023 0800
GV 8000 GB	2	27599 005 2300	75988 023 0800
GV 8000 SV/2, GV 8000 SV/5, GV 8050 SV	2	27599 005 2200	75988 023 0800
GV 8300...	4	27599 005 1500	75988 023 0900
GV 8400..., GV 8450 HiFi	6	27599 005 2000	75988 023 1000
GV 9000	2	27599 005 3100	
GV 9000 SV	2	27599 005 3100	
GV 9000 SV/5	2	27599 005 3000	
GV 9300 EURO	4	27599 005 3300	
GV 9300 SV	4	27599 005 3200	
GV 9300 SV/5	4	27599 005 3200	
GV 9400 EURO	6	75988 046 5000	
GV 9400 HiFi	6	75988 046 4300	
GV 9400 HiFi/5	6	75988 046 4300	
GV 9400 NIC	6	75988 046 4300	
KV 8001 VPS/5	2	27599 005 2200	75988 023 0800
KV 8301 VPS/5	4	27599 005 1500	75988 023 0900
KV 8401 HiFi/5	6	27599 005 2000	75988 023 1000
SE 1102 SV	2	75988 046 0300	
SE 1105 HiFi	6	75988 046 4300	
SE 1106 HiFi/NIC	6	75988 046 4300	
SE 1200 SV	2	27599 005 3900	
SE 1205 HiFi	6	27599 005 4200	
SE 1206 HiFi/NIC	6	27599 005 4200	
SE 1300 SV	2	27599 005 4300	
SE 1305 HiFi	6	27599 005 4500	
SE 1400 SV	2	27599 005 4800	
SE 1405 HiFi/NIC	6	27599 005 4700	
SE 8100 SV	2	27599 005 2200	75988 023 0800
SE 8105 HiFi	6	27599 005 2000	75988 023 1000
SE 9100 SV	2	27599 005 3100	
SE 9102 SV	2	75988 046 0300	
SE 9105 HiFi	6	75988 046 4300	
SE 9106 HiFi/NIC	6	75988 046 4300	
TVR 3705	2	27599 005 0800	75988 001 3300
TVR 3705 FR	2	27599 005 0800	75988 001 3300
TVR 3730 Text	2	27599 005 0800	75988 001 3300
TVR 3730 Text/FR	2	27599 005 0800	75988 001 3300
TVR 3730 Text/GB	2	27599 005 0800	75988 001 3300
TVR 3735 FR/TOP	2	27599 005 3500	
TVR 3735/1 TOP	2	27599 005 3400	
TVR 3735/2 TOP	2	27599 005 3400	
TVR 3740 FR/TOP	2	27599 005 3500	
TVR 3740 FT/GB	2	27599 005 3400	
TVR 3740/1 TOP	2	27599 005 3400	
TVR 3740/2 TOP	2	27599 005 3400	
TVR 5100	2	27599 005 0700	75988 001 3300
TVR 5100 Text (Code BA)	2	27599 005 0800	75988 001 3300
TVR 5130 Text	2	27599 005 0800	75988 001 3300
TVR 5130 FR	2	27599 005 0800	75988 001 3300
TVR 5130 Text/GB	2	27599 005 0800	75988 001 3300
TVR 5530 Text	2	27599 005 0800	75988 001 3300

Headwheels and Head Cylinders

Type of VCR	Heads	Headwheel Part No.	Head Cylinder Part No.
TVR 5530 text/FR	2	27599 005 0800	75988 001 3300
TVR 5540 FR/TOP	4	27599 005 3700	
TVR 5540 FT/GB	4	27599 005 3600	
TVR 5540/1 TOP	4	27599 005 3600	
TVR 5540/2 TOP	4	27599 005 3600	

Service Manuals Video

Type of set	Part Number	Kind of Manual
GV 1010 SV/1	72010 535 2000	Service Manual
	72010 535 2200	Supplement
	72010 536 1500	Training (D)
GV 1030 HiFi	72010 535 2000	Service Manual
	72010 535 2200	Supplement
	72010 536 1500	Training (D)
GV 29 EURO	72010 536 3500	Service Manual
	72010 536 3600	Supplement
GV 29 VPS	72010 535 1500	Service Manual
GV 29 VPS/5	72010 535 1500	Service Manual
GV 3000 VPS/1	72010 540 5000	Service Manual
GV 3000 VPS/2	72010 540 5000	Service Manual
GV 3004 PDC/EURO	72010 540 5000	Service Manual
GV 3005 VPS	72010 540 5000	Service Manual
GV 3006 VPS	72010 540 5000	Service Manual
GV 3010 SV/1	72010 540 5000	Service Manual
GV 3010 SV/2	72010 540 5000	Service Manual
GV 3015 SV	72010 540 5000	Service Manual
GV 3042 NIC	72010 540 5000	Service Manual
GV 3043 HiFi	72010 540 5000	Service Manual
GV 3044 NIC/EURO	72010 540 5000	Service Manual
GV 3045 HiFi	72010 540 5000	Service Manual
GV 3100 VPS/1	72010 540 9000	Service Manual
GV 3100 VPS/2	72010 540 9000	Service Manual
GV 3105 VPS	72010 540 9000	Service Manual
GV 3106 VPS	72010 540 9000	Service Manual
GV 3110 SV/1	72010 540 9000	Service Manual
GV 3110 SV/2	72010 540 9000	Service Manual
GV 3115 SV	72010 540 9000	Service Manual
GV 3142 NIC	72010 540 9000	Service Manual
GV 3143 HiFi	72010 540 9000	Service Manual
	72010 540 9200	Supplement
GV 3145 HiFi	72010 540 9000	Service Manual
GV 3146 MULTI	72010 540 9000	Service Manual
	72010 540 9200	Supplement
GV 3147 HiFi	72010 540 9000	Service Manual
	72010 540 9100	Supplement
GV 3200 VPS	72010 541 1000	Service Manual
GV 3205 VPS	72010 541 1000	Service Manual
GV 3242 NIC/1	72010 541 1000	Service Manual
GV 3242 NIC/2	72010 541 1000	Service Manual
GV 3243 HiFi	72010 541 1000	Service Manual
GV 3245 HiFi	72010 541 1000	Service Manual
GV 3247 HiFi	72010 541 1000	Service Manual
GV 5052 NIC	72010 540 5000	Service Manual
GV 5053 HiFi	72010 540 5000	Service Manual
GV 5054 NIC/EURO	72010 540 5000	Service Manual
GV 5152 NIC	72010 540 9000	Service Manual

Observe also the Instructions given in the Safety Service Manual Part No. 72010 800 0000!

Service Manuals Video

Type of set	Part Number	Kind of Manual
GV 5153 HiFi	72010 540 9000	Service Manual
GV 5253 HiFi	72010 541 1000	Service Manual
GV 6062 NIC	72010 540 5000 72010 540 5100	Service Manual Supplement
GV 6063 HiFi	72010 540 5000 72010 540 5100	Service Manual Supplement
GV 6065 HiFi	72010 540 5000 72010 540 5100	Service Manual Supplement
GV 6162 NIC	72010 540 9000	Service Manual
GV 6163 HiFi	72010 540 9000	Service Manual
GV 6165 HiFi	72010 540 9000 72010 540 9200	Service Manual Supplement
GV 6167 HiFi	72010 540 9000 72010 540 9100	Service Manual Supplement
GV 6262 NIC	72010 541 1000	Service Manual
GV 6263 HiFi	72010 541 1000	Service Manual
GV 6265 HiFi	72010 541 1000	Service Manual
GV 8000 EURO	72010 530 3000 72010 530 3100 72010 531 4000 72010 531 4000	Service Manual Supplement Training (D) Training (GB)
GV 8000 GB	72010 530 2500 72010 530 2600 72010 531 4000 72010 531 4000	Service Manual Supplement Training (D) Training (GB)
GV 8000 SV/1	72010 530 2500 72010 530 2600 72010 531 4000 72010 531 4000	Service Manual Supplement Training (D) Training (GB)
GV 8000 SV/2	72010 530 2500 72010 530 2600 72010 531 4000 72010 531 4000	Service Manual Supplement Training (D) Training (GB)
GV 8000 SV/5	72010 530 2500 72010 530 2600 72010 531 4000 72010 531 4000	Service Manual Supplement Training (D) Training (GB)
GV 8050 SV	72010 530 2500 72010 530 2600 72010 531 4000 72010 531 4000	Service Manual Supplement Training (D) Training (GB)
GV 819 M	72010 534 0000	Service Manual
GV 8300 EURO	72010 530 3000 72010 530 3100 72010 531 4000 72010 531 4000	Service Manual Supplement Training (D) Training (GB)
GV 8300 SV	72010 530 2500 72010 530 2600 72010 531 4000 72010 531 4000	Service Manual Supplement Training (D) Training (GB)
GV 8300 SV/5	72010 530 2500 72010 530 2600 72010 531 4000 72010 531 4000	Service Manual Supplement Training (D) Training (GB)
GV 8400 EURO	72010 530 3000 72010 530 3100 72010 531 4000 72010 531 4000	Service Manual Supplement Training (D) Training (GB)

Observe also the Instructions given in the Safety Service Manual Part No. 72010 800 0000!

Service Manuals Video

Type of set	Part Number	Kind of Manual
GV 8400 GB	72010 530 2500	Service Manual
	72010 530 2600	Supplement
	72010 531 4000	Training (D)
	72010 531 4000	Training (GB)
GV 8400 HiFi	72010 530 2500	Service Manual
	72010 530 2600	Supplement
	72010 531 4000	Training (D)
	72010 531 4000	Training (GB)
GV 8400 HiFi/5	72010 530 2500	Service Manual
	72010 530 2600	Supplement
	72010 531 4000	Training (D)
	72010 531 4000	Training (GB)
GV 8400 NIC 1	72010 530 2500	Service Manual
	72010 530 2600	Supplement
	72010 531 4000	Training (D)
	72010 531 4000	Training (GB)
GV 8400 NIC 2	72010 530 2500	Service Manual
	72010 530 2600	Supplement
	72010 531 4000	Training (D)
	72010 531 4000	Training (GB)
GV 8450 HiFi	72010 530 2500	Service Manual
	72010 530 2600	Supplement
	72010 531 4000	Training (D)
	72010 531 4000	Training (GB)
GV 900 SV/1	72010 535 2000	Service Manual
	72010 535 2100	Supplement
	72010 536 1500	Training (D)
GV 900 SV/2	72010 535 2000	Service Manual
	72010 535 2100	Supplement
	72010 536 1500	Training (D)
GV 9000	72010 535 1500	Service Manual
	72010 535 1600	Supplement
GV 9000 SV	72010 535 1500	Service Manual
	72010 535 1700	Supplement
GV 9000 SV/5	72010 535 1500	Service Manual
	72010 535 1700	Supplement
GV 920 HiFi	72010 535 2000	Service Manual
	72010 535 2100	Supplement
	72010 536 1500	Training (D)
GV 9300 EURO	72010 536 3500	Service Manual
	72010 536 3600	Supplement
GV 9300 SV	72010 535 1500	Service Manual
	72010 535 1700	Supplement
GV 9300 SV/5	72010 535 1500	Service Manual
	72010 535 1700	Supplement
GV 94 HiFi	72010 536 8500	Service Manual
	72010 536 8600	Service Manual
GV 94 NIC	72010 536 8500	Service Manual
	72010 536 8600	Service Manual
GV 940 EURO	72010 535 2000	Service Manual
	72010 535 2100	Supplement
	72010 536 1500	Training (D)
GV 940 HiFi	72010 535 2000	Service Manual
	72010 535 2100	Supplement
	72010 536 1500	Training (D)
GV 940 HiFi/5	72010 535 2000	Service Manual
	72010 535 2100	Supplement
	72010 536 1500	Training (D)
GV 940 NIC	72010 535 2000	Service Manual
	72010 535 2100	Supplement
	72010 536 1500	Training (D)

Observe also the Instructions given in the Safety Service Manual Part No. 72010 800 0000!

Service Manuals Video

Type of set	Part Number	Kind of Manual
GV 9400 EURO	72010 535 2000	Service Manual
	72010 535 2100	Supplement
	72010 536 1500	Training (D)
GV 9400 HiFi	72010 535 2000	Service Manual
	72010 535 2200	Supplement
	72010 536 1500	Training (D)
GV 9400 HiFi/5	72010 535 2000	Service Manual
	72010 535 2100	Supplement
	72010 536 1500	Training (D)
GV 9400 NIC	72010 535 2000	Service Manual
	72010 535 2100	Supplement
	72010 535 2200	Supplement
	72010 536 1500	Training (D)
GV 950 HiFi/NIC	72010 535 2000	Service Manual
	72010 535 2100	Supplement
	72010 535 2200	Supplement
	72010 536 1500	Training (D)
KV 8001 VPS/5	72010 530 2500	Service Manual
	72010 530 2600	Supplement
	72010 531 4000	Training (D)
	72010 531 4000	Training (GB)
KV 8301 VPS/5	72010 530 2500	Service Manual
	72010 530 2600	Supplement
	72010 531 4000	Training (D)
	72010 531 4000	Training (GB)
KV 8401 HiFi/5	72010 530 2500	Service Manual
	72010 530 2600	Supplement
	72010 531 4000	Training (D)
	72010 531 4000	Training (GB)
SE 1102 SV	72010 535 2000	Service Manual
	72010 535 2200	Supplement
	72010 536 1500	Training (D)
SE 1105 HiFi	72010 535 2000	Service Manual
	72010 535 2200	Supplement
	72010 536 1500	Training (D)
SE 1106 HiFi/NIC	72010 535 2000	Service Manual
	72010 535 2200	Supplement
	72010 536 1500	Training (D)
SE 1200 SV	72010 540 5000	Service Manual
SE 1205 HiFi	72010 540 5000	Service Manual
SE 1206 HiFi/NIC	72010 540 5000	Service Manual
	72010 540 5100	Supplement
SE 1300 SV	72010 540 9000	Service Manual
SE 1305 HiFi	72010 540 9000	Service Manual
SE 1400 SV	72010 541 1000	Service Manual
SE 1405 HiFi/NIC	72010 541 1000	Service Manual
SE 8100 SV / Palermo	72010 530 2500	Service Manual
	72010 530 2600	Supplement
	72010 531 4000	Training (D)
	72010 531 4000	Training (GB)
SE 8105 HiFi / Sevilla	72010 530 2500	Service Manual
	72010 530 2600	Supplement
	72010 531 4000	Training (D)
	72010 531 4000	Training (GB)
SE 9100 SV / Palermo	72010 535 1500	Service Manual
	72010 535 1600	Supplement
SE 9102 SV / Barcelona	72010 535 2000	Service Manual
	72010 536 1500	Training (D)
SE 9105 HiFi / Sevilla	72010 535 2000	Service Manual
	72010 536 1500	Supplement

Observe also the Instructions given in the Safety Service Manual Part No. 72010 800 0000!

Service Manuals Video

Type of set	Part Number	Kind of Manual
SE 9106 HiFi/NIC / Madrid	72010 535 2000	Service Manual
	72010 536 1500	Training (D)
VCR-SAT 1	72010 537 5500	Service Manual

Service Manuals TVR

Type of set	Part Number	Kind of Manual
TVR 3730 Text (Code AA)	72010 524 9500	Service Manual
	72010 524 9800	Supplement
	72010 524 9900	Supplement
TVR 3730 Text/FR	72010 525 0000	Service Manual
	72010 525 0200	Supplement
	72010 525 0300	Supplement
TVR 3730 Text/GB (Code AA)	72010 524 9500	Service Manual
	72010 524 9800	Supplement
	72010 524 9900	Supplement
TVR 3735 FR/TOP	72010 536 6000	Service Manual
	72010 536 6100	Supplement
TVR 3735/1 TOP	72010 536 6000	Service Manual
	72010 536 6100	Supplement
TVR 3735/2 TOP	72010 536 6000	Service Manual
	72010 536 6100	Supplement
TVR 3740 FR/TOP	72010 536 6000	Service Manual
	72010 536 6100	Supplement
TVR 3740 FT/GB	72010 536 6000	Service Manual
	72010 536 6100	Supplement
TVR 3740/1 TOP	72010 536 6000	Service Manual
	72010 536 6100	Supplement
TVR 3740/2 TOP	72010 536 6000	Service Manual
	72010 536 6100	Supplement
TVR 5100 Text (Code BA)	72010 524 9500	Service Manual
	72010 524 9800	Supplement
	72010 524 9900	Supplement
TVR 5130 FR	72010 525 0000	Service Manual
	72010 525 0200	Supplement
	72010 525 0300	Supplement
TVR 5130 Text (Code AA)	72010 524 9500	Service Manual
	72010 524 9800	Supplement
	72010 524 9900	Supplement
TVR 5130 Text/GB (Code AA)	72010 524 9500	Service Manual
	72010 524 9800	Supplement
	72010 524 9900	Supplement
TVR 5530 Text (Code AA)	72010 524 9500	Service Manual
	72010 524 9800	Supplement
	72010 524 9900	Supplement
TVR 5530 text/FR	72010 525 0000	Service Manual
	72010 525 0200	Supplement
	72010 525 0300	Supplement
TVR 5540 FR/TOP	72010 536 6000	Service Manual
	72010 536 6100	Supplement
TVR 5540 FT/GB	72010 536 6000	Service Manual
	72010 536 6100	Supplement
TVR 5540/1 TOP	72010 536 6000	Service Manual
	72010 536 6100	Supplement
TVR 5540/2 TOP	72010 536 6000	Service Manual
	72010 536 6100	Supplement

Observe also the Instructions given in the Safety Service Manual Part No. 72010 800 0000!

Service Manuals DVD Player

Type of set	Part Number	Kind of Manual
DVD-Modul f. Arganto	72010 027 9000	Service Manual
	72010 027 9100	Supplement
	72010 027 9200	Supplement
DVD-Kit1	72010 042 4000	Service Manual
GDP 2200	–	Central Repair
GDP 3100	72010 540 9500	Service Manual
GDP 3200	72010 540 9500	Service Manual
	72010 540 9600	Supplement
GDP 3205	72010 540 9500	Service Manual
	72010 540 9600	Supplement
GDP 3200/KIT710	–	Central Repair
GDP 3205/KIT710	–	Central Repair
GDP 4200	–	Central Repair
GDP 4204	–	Central Repair
GDP 5100...	72010 540 8500	Service Manual
	72010 540 8600	Supplement
	72010 540 8700	Supplement
GDP 5102	72010 540 8500	Service Manual
	72010 540 8600	Supplement
	72010 540 8700	Supplement
GDP 5105	72010 540 8500	Service Manual
	72010 540 8600	Supplement
	72010 540 8700	Supplement
GDP 5120	72010 540 8500	Service Manual
	72010 540 8600	Supplement
	72010 540 8700	Supplement
GDP 6150...	72010 540 8500	Service Manual
	72010 540 8600	Supplement
	72010 540 8700	Supplement
GDP 6155	72010 540 8500	Service Manual
	72010 540 8600	Supplement
	72010 540 8700	Supplement
GDV 100 D	72010 531 9500	Service Manual
GDV 100 D / 002	72010 531 9600	Service Manual
GDV 110 D	72010 531 9600	Service Manual
	72010 537 2000	Supplement
GDV 120	72010 539 3500	Service Manual
GDV 120/02	72010 539 3500	Service Manual
GDV 130	72010 537 9500	Service Manual
	72010 537 9700	Supplement
	72010 537 9800	Supplement
GDV 130 /2	72010 537 9500	Service Manual
	72010 537 9700	Supplement
GDV 130 /4	72010 537 9500	Service Manual
GDV 200	72010 538 0000	Service Manual
GDV Modul 1	72010 027 9000	Service Manual
SE 1210	72010 537 9500	Service Manual
	72010 537 9600	Supplement
	72010 537 9700	Supplement
SE 1230	72010 540 8500	Service Manual
	72010 540 8600	Supplement
	72010 540 8700	Supplement
SE 1235	72010 540 8500	Service Manual
	72010 540 8600	Supplement
	72010 540 8700	Supplement

Observe also the Instructions given in the Safety Service Manual Part No. 72010 800 0000!

GRUNDIG Tele-Pilot® Remote Control Handsets/Overview Video Product Range



RP 100 D
75988 042 7700



RP 700
72011 713 0000



RP 819
75988 323 9000



TP 80 V
75988 045 5900



TP 81 D
26728 012 0001
26728 012 0201 (sw)



TP 82 V
75988 065 0000



TP 83 D
26728 012 0101



TP 84 D
72011 713 1500



TP 90 V
72011 713 1000



TP 91 V
72011 713 1400



TP 92 V
72011 713 2000
72011 713 1900 (sw)



TP 93 V
72011 713 2200
72011 713 2100 (sw)



TP 870 T
29642 061 1300

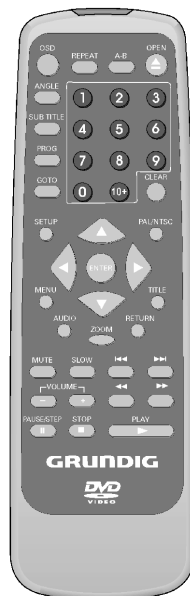

TP 2200
72011 713 2800



TVP 762
75988 017 0600



TVP 763
75988 019 9700

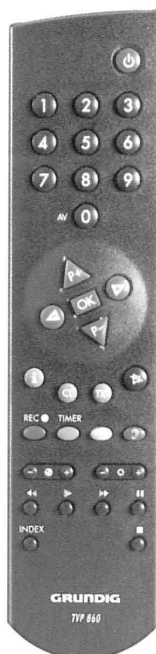

TVP 860
72011 650 0400



Video Control 1
72011 610 0000

Video Control 1
replaces
the following types:

Type	Code
RP 4	205
RP 6	201
RC 6	201
RP 50	205
VP 386	202
VP 615	206
RC 615	206

and variants

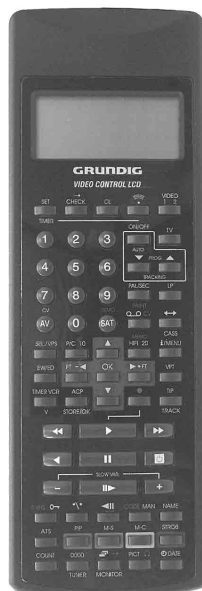

Video Control LCD
72011 615 0000

Video Control LCD
replaces
the following types:

Type	Code
RP 5 LCD	1
RP 6 LCD	1
RP 13 LCD	2
RP 20 LCD	3
RP 25 LCD	4
RP 30 LCD	5
RP 33 LCD	6
RP 35 LCD	6
RC 60 LCD	7
RP 65 LCD	1
RP 70 LCD	1
RC 70 LCD	1
RC 75 LCD	7
RP 75 LCD	7
RP 85 LCD	8
RP 90 LCD	7
RP 95 LCD	7
RP 130 LCD	2

and variants

Programming:
insert battery -> SEL in
display -> enter the code
and confirm with OK.

Video

Video Remote Control Codes

VCR	VCR Remote Control Code			RC Transmitter	Transmitter RC Code		
	RC 5 Code	16Bit Level 1	16Bit Level 2		RC 5 Code	16Bit Level 1	16Bit Level 2
GV 29 EURO	-	●	●	TP 90 V	-	●	●
GV 29 VPS	-	●	●	TP 90 V	-	●	●
GV 29 VPS/5	-	●	●	TP 90 V	-	●	●
GV 94 HiFi	-	●	●	TP 90 V	-	●	●
GV 94 NIC	-	●	●	TP 90 V	-	●	●
GV 819 M	-	-	-	RP 819	-	-	-
GV 900 SV/1	-	●	●	TP 90 V	-	●	●
GV 900 SV/2	-	●	●	TP 90 V	-	●	●
GV 920 HiFi	-	●	●	TP 90 V	-	●	●
GV 940 EURO	-	●	●	TP 90 V	-	●	●
GV 940 HiFi	-	●	●	TP 90 V	-	●	●
GV 940 HiFi/5	-	●	●	TP 90 V	-	●	●
GV 940 NIC	-	●	●	TP 90 V	-	●	●
GV 950 HiFi/NIC	-	●	●	TP 90 V	-	●	●
GV 1010 SV/1	-	●	●	TP 90 V	-	●	●
GV 1030 HiFi	-	●	●	TP 90 V	-	●	●
GV 3000 VPS/1	-	●	●	TP 90 V	-	●	●
GV 3000 VPS/2	-	●	●	TP 90 V	-	●	●
GV 3004 PDC/EURO	-	●	●	TP 90 V	-	●	●
GV 3005 VPS	-	●	●	TP 90 V	-	●	●
GV 3006 VPS	-	●	●	TP 90 V	-	●	●
GV 3010 SV/1	-	●	●	TP 90 V	-	●	●
GV 3010 SV/2	-	●	●	TP 90 V	-	●	●
GV 3015 SV	-	●	●	TP 90 V	-	●	●
GV 3042 NIC	-	●	●	TP 90 V	-	●	●
GV 3043 HiFi	-	●	●	TP 90 V	-	●	●
GV 3044 NIC/EURO	-	●	●	TP 90 V	-	●	●
GV 3045 HiFi	-	●	●	TP 90 V	-	●	●
GV 3100 VPS/1	-	●	●	TP 92 V	-	●	-
GV 3100 VPS/2	-	●	●	TP 92 V	-	●	-
GV 3105 VPS	-	●	●	TP 92 V	-	●	-
GV 3106 VPS	-	●	●	TP 92 V	-	●	-
GV 3110 SV/1	-	●	●	TP 92 V	-	●	-
GV 3110 SV/2	-	●	●	TP 92 V	-	●	-
GV 3115 SV	-	●	●	TP 92 V	-	●	-
GV 3142 NIC	-	●	●	TP 92 V	-	●	-
GV 3143 HiFi	-	●	●	TP 92 V	-	●	-
GV 3145 HiFi	-	●	●	TP 92 V	-	●	-
GV 3146 MULTI	-	●	●	TP 92 V	-	●	-
GV 3147 HiFi	-	●	●	TP 92 V	-	●	-
GV 3200 VPS	-	●	●	TP 92 V	-	●	-
GV 3205 VPS	-	●	●	TP 92 V	-	●	-
GV 3242 NIC/1	-	●	●	TP 92 V	-	●	-
GV 3242 NIC/2	-	●	●	TP 92 V	-	●	-
GV 3243 HiFi	-	●	●	TP 92 V	-	●	-
GV 3245 HiFi	-	●	●	TP 92 V	-	●	-
GV 3247 HiFi	-	●	●	TP 92 V	-	●	-
GV 5052 NIC	-	●	●	TP 90 V	-	●	●
GV 5053 HiFi	-	●	●	TP 90 V	-	●	●
GV 5054 NIC/EURO	-	●	●	TP 90 V	-	●	●
GV 5152 NIC	-	●	●	TP 92 V	-	●	-
GV 5153 HiFi	-	●	●	TP 92 V	-	●	-
GV 5253 HiFi	-	●	●	TP 92 V	-	●	-
GV 6062 NIC	-	●	●	TP 91 V	-	●	●

VCR	VCR Remote Control Code			RC Transmitter	Transmitter RC Code		
	RC 5 Code	16Bit Level 1	16Bit Level 2		RC 5 Code	16Bit Level 1	16Bit Level 2
GV 6063 HiFi	-	●	●	TP 91 V	-	●	●
GV 6065 HiFi	-	●	●	TP 91 V	-	●	●
GV 6162 NIC	-	●	●	TP 93 V	-	●	●
GV 6163 HiFi	-	●	●	TP 93 V	-	●	●
GV 6165 HiFi	-	●	●	TP 93 V	-	●	●
GV 6167 HiFi	-	●	●	TP 93 V	-	●	●
GV 6262 NIC	-	●	●	TP 92 V	-	●	-
GV 6263 HiFi	-	●	●	TP 92 V	-	●	-
GV 6265 HiFi	-	●	●	TP 92 V	-	●	-
GV 8000 EURO	●	-	-	RP 700 FR	●	-	-
GV 8000 GB	●	-	-	RP 700	●	-	-
GV 8000 SV/1	●	-	-	RP 700	●	-	-
GV 8000 SV/2	●	-	-	RP 700	●	-	-
GV 8000 SV/5	●	-	-	RP 700	●	-	-
GV 8050 SV	●	-	-	RP 700	●	-	-
GV 8300 EURO	●	-	-	RP 700 FR	●	-	-
GV 8300 SV	●	-	-	RP 700	●	-	-
GV 8300 SV/5	●	-	-	RP 700	●	-	-
GV 8400 EURO	●	-	-	RP 700 FR	●	-	-
GV 8400 GB	●	-	-	RP 700	●	-	-
GV 8400 HiFi	●	-	-	RP 700	●	-	-
GV 8400 HiFi/5	●	-	-	RP 700	●	-	-
GV 8400 NIC 1	●	-	-	RP 700	●	-	-
GV 8400 NIC 2	●	-	-	RP 700	●	-	-
GV 8450 HiFi	●	-	-	RP 700	●	-	-
GV 9000	-	●	●	TP 90 V	-	●	●
GV 9000 SV	-	●	●	TP 90 V	-	●	●
GV 9000 SV/5	-	●	●	TP 90 V	-	●	●
GV 9300 EURO	-	●	●	TP 90 V	-	●	●
GV 9300 SV	-	●	●	TP 90 V	-	●	●
GV 9300 SV/5	-	●	●	TP 90 V	-	●	●
GV 9400 EURO	-	●	●	TP 90 V	-	●	●
GV 9400 HiFi	-	●	●	TP 90 V	-	●	●
GV 9400 HiFi/5	-	●	●	TP 90 V	-	●	●
GV 9400 NIC	-	●	●	TP 90 V	-	●	●
KV 8001 VPS/5	●	-	-	RP 700	●	-	-
KV 8301 VPS/5	●	-	-	RP 700	●	-	-
KV 8401 HiFi/5	●	-	-	RP 700	●	-	-
SE 1102 SV	-	●	●	TP 90 V	-	●	●
SE 1105 HiFi	-	●	●	TP 90 V	-	●	●
SE 1106 HiFi/NIC	-	●	●	TP 90 V	-	●	●
SE 1200 SV	-	●	●	TP 90 V	-	●	●
SE 1205 HiFi	-	●	●	TP 90 V	-	●	●
SE 1206 HiFi/NIC	-	●	●	TP 90 V	-	●	●
SE 1300 SV	-	●	●	TP 92 V	-	●	-
SE 1305 HiFi	-	●	●	TP 92 V	-	●	-
SE 1400 SV	-	●	●	TP 92 V	-	●	-
SE 1405 HiFi/NIC	-	●	●	TP 92 V	-	●	-
SE 8100 SV / Palermo	●	-	-	RP 700	●	-	-
SE 8105 HiFi / Sevilla	●	-	-	RP 700	●	-	-
SE 9100 SV	-	●	●	TP 90 V	-	●	●
SE 9102 SV	-	●	●	TP 90 V	-	●	●
SE 9105 HiFi	-	●	●	TP 90 V	-	●	●
SE 9106 HiFi/NIC	-	●	●	TP 91 V	-	●	●

Video

Cancelling the Electronic Lock

VS 200 to VS 267

- Switch the video recorder off
- Remove the top of the cabinet
- Unplug the B1 connector on the sequence control
- Switch the recorder on
- After approx. 2 seconds, re-insert the B1 connector
- Switch the video recorder off
- Refit the top of the cabinet

VS 300 to VS 460

- Switch the video recorder off
- Remove the top of the cabinet
- Switch the recorder on
- Interconnect the service test points on the keyboard control unit for a short time
- Press the STOP button
- Switch the video recorder off
- Refit the top of the cabinet

VS 500

- Enter the numbers 4 9 3 4 on the remote control handset in this order and confirm with the button "0000"
- Press the STOP button

VS 505 to VS 510

- Enter the numbers 4 9 3 4 on the remote control handset in this order and confirm with the "OK" button
- Press the STOP button

VS 520 to VS 550

- Switch the video recorder off
- Remove the top of the cabinet
- Switch the recorder on
- Interconnect the service test points on the keyboard control unit for a short time
- Press the STOP button
- Switch the video recorder off
- Refit the top of the cabinet

VS 600 to VS 960

- Enter the numbers 4 9 3 4 on the remote control handset in this order and confirm with the "OK" button
- Press the STOP button

GV 200 to GV 250

- Press the "CODE" button on the remote control handset
- Enter the numbers 4 9 3 4 on the remote control handset in this order and confirm with the "OK" button
- Press the STOP button

GV 201-1

- Press the "STANDBY" button on the remote control handset until "FREE" is indicated on the display of the video recorder

GV 280PC, GV 280S

- Enter the numbers 4 9 3 4 on the remote control handset in this order and confirm with the "OK" button
- Press the STOP button

GV 400, GV 400 GB and GV 400 OST

- With the video recorder switched off (Standby) press the Stop button on the remote control handset until "UNLO" appears on the display of the recorder.

GV 400 VPS and GV 401 VPT

- Press the "CODE" button on the remote control handset
- Enter the numbers 4 9 3 4 in this order and confirm with the "OK" button
- Press the "STANDBY" button or disconnect the video recorder from the mains

GV 402

- With the video recorder switched off (Standby) press the Stop button on the remote control handset until "UNLO" appears on the display of the recorder.

GV 404 SV, GV 405 EURO and GV 406 EURO

- Press the "CODE" button on the remote control handset
- Enter the numbers 4 9 3 4 in this order and confirm with the "OK" button
- Press the "STANDBY" button or disconnect the video recorder from the mains

GV 410

- With the video recorder switched off (Standby) press the Stop button on the remote control handset until "UNLO" appears on the display of the recorder.

GV 410 VPS and GV 411

- Press the "CODE" button on the remote control handset
- Enter the numbers 4 9 3 4 in this order and confirm with the "OK" button
- Press the "STANDBY" button or disconnect the video recorder from the mains

GV 411-1

- Press and hold the "STANDBY" button on the remote control handset (ca. 5 seconds) until "UNLOCKED" appears on the display of the video recorder.

GV 411-2

Without parental lock / electronic lock

GV 411 OST and GV 412

- With the video recorder switched off (Standby) press the Stop button on the remote control handset until "UNLO" appears on the display of the recorder.

GV 414 SV, GV 415 EURO, GV 416 EURO and GV 420 VPT

- Press the "CODE" button on the remote control handset
- Enter the numbers 4 9 3 4 in this order and confirm with the "OK" button
- Press the "STANDBY" button or disconnect the video recorder from the mains

GV 430 and GV 430 GB

- With the video recorder switched off (Standby) press the Stop button on the remote control handset until "UNLO" appears on the display of the recorder.

GV 430 VPS, GV 434 SV and GV 435 EURO

- Press the "CODE" button on the remote control handset
- Enter the numbers 4 9 3 4 in this order and confirm with the "OK" button
- Press the "STANDBY" button or disconnect the video recorder from the mains

GV 440... , GV 450... , GV 460... , GV 464... , GV 465 EURO and GV 470...

- Press the "CODE" button on the remote control handset
- Enter the numbers 4 9 3 4 in this order and confirm with the "OK" button
- Press the "STANDBY" button or disconnect the video recorder from the mains

GV 4000 VPS and GV 4001

- With the video recorder switched off (Standby) press the Stop button on the remote control handset until "UNLO" appears on the display of the recorder.

GV 4003 VPS

- With the video recorder switched off (Standby) press the Stop button on the remote control handset until "FREE" appears on the display of the recorder.

GV 4010 SV-VPT, GV 4092..., GV 4192 VPS, GV 4200 SV-VPT, GV 4400 HiFi, GV 4592...

- Press the "CODE" button on the remote control handset
- Enter the numbers 4 9 3 4 in this order and confirm with the "OK" button
- Press the "STANDBY" button or disconnect the video recorder from the mains

SE 4100 VPS, SE 4104 SV and SE 4120 SV

- Press the "CODE" button on the remote control handset
- Enter the numbers 4 9 3 4 in this order and confirm with the "OK" button
- Press the "STANDBY" button or disconnect the video recorder from the mains

MV 4005 and MV 4105

- With the video recorder switched off (Standby) press the Stop button on the remote control handset until "UNLO" appears on the display of the recorder.

GV 500..., GV 501 VPT, GV 505 EURO and GV 506 EURO

- Press the "CODE" button on the remote control handset
- Enter the numbers 4 9 3 4 in this order and confirm with the "OK" button
- Press the "STANDBY" button or disconnect the video recorder from the mains

GV 509 M

Without child lock / electronic lock

GV 510 SV, GV 511, GV 515 EURO, GV 530..., GV 535 EURO, GV 540..., GV 545 EURO, GV 560... and GV 565 EURO

- Press the "CODE" button on the remote control handset
- Enter the numbers 4 9 3 4 in this order and confirm with the "OK" button
- Press the "STANDBY" button or disconnect the video recorder from the mains

GV 5000, GV 5000 GB, GV 5000 VPS and GV 5000 VPS/5

- Press the "STANDBY" button on the remote control handset until "FREE" is indicated on the display of the video recorder

GV 5000 SAA

- Press the "STANDBY" button on the remote control handset until "UNLOCKED" is indicated on the display of the video recorder

GV 5002 VPS, GV 5003, GV 5008 and GV 5050

- Press the "STANDBY" button on the remote control handset until "FREE" is indicated on the display of the video recorder

GV 5050 SV, GV 5050 SV/1, GV 5055 EURO and GV 5095...

- Press the "CODE" button on the remote control handset
- Enter the numbers 4 9 3 4 in this order and confirm with the "OK" button
- Press the "STANDBY" button or disconnect the video recorder from the mains

GV 5300...

- Press the "STANDBY" button on the remote control handset until "FREE" is indicated on the display of the video recorder

GV 5395... , GV 5400... and GV 5695 HiFi

- Press the "CODE" button on the remote control handset
- Enter the numbers 4 9 3 4 in this order and confirm with the "OK" button
- Press the "STANDBY" button or disconnect the video recorder from the mains

GV 25 SV/5 and GV 45 SV/5

- Press the "STANDBY" button on the remote control handset until "FREE" is indicated on the display of the video recorder

KV 5001 VPS/5 and KV 5301 VPS/5

- Press the "STANDBY" button on the remote control handset until "FREE" is indicated on the display of the video recorder

GV 600, GV 630, GV 640..., GV 645..., GV 650..., GV 660..., GV 665..., GV 670..., GV 690..., GV 6096..., GV 6396..., GV 6596...

- Press the "CODE" button on the remote control handset
- Enter the numbers 4 9 3 4 in this order and confirm with the "OK" button
- Press the "STANDBY" button or disconnect the video recorder from the mains

GVP 600 ICN EURO

- Press the "STANDBY" button on the remote control handset until "FREE" is indicated on the display of the video recorder

GV 740..., GV 745 EURO

- Press the "CODE" button on the remote control handset
- Enter the numbers 4 9 3 4 in this order and confirm with the "OK" button
- Press the "STANDBY" button or disconnect the video recorder from the mains







GV 7400...

- Press and hold down the remote control buttons "STANDBY" and "SELECT" simultaneously until the key symbol disappears from the display of the recorder

GV 7497 NIC

- Press the "CODE" button on the remote control handset
- Enter the numbers 4 9 3 4 in this order and confirm with the "OK" button
- Press the "STANDBY" button or disconnect the video recorder from the mains





GV 29..., GV 94..., GV 9000..., GV 9300...

- Select the "AV" programme position on the TV set for playing back a recording
- Switch the video recorder on with the  button
- Call up the main menu with the "i INFO" button
- Select "MODE" with the   buttons and confirm with the "OK" button
- Select "CHILD LOCK" with the   buttons
- Select "OFF" with the  button and confirm with "OK"

GV 900..., GV 920 HiFi, GV 940..., GV 950..., GV 1010..., GV 1030..., GV 9400...

- Press the "STANDBY" button on the remote control handset until the key symbol disappears from the display of the recorder

GV 3000...GV 3015..., GV 3042...GV 3045, GV 5052...GV5054, GV 6062..., GV 6063...

- Press the buttons "STANDBY" and "TIMER ON/OFF" simultaneously (Display "----")
- Press the buttons     and "OK" in this order.

**GV 3100...GV 3115, GV 3142...GV 3147, GV 5152, GV 5153, GV 6162...GV 6167
GV 3200, GV 3205, GV 3242...GV 3247, GV 5253, GV 6262...GV 6265**

- Press the buttons   – + and OK on the remote control in this order.

GDV Modul 1, DVD Modul, GDV 100..., GDV 110, GDV 200

- Press the button  4 times instead of your code number.

GDV 120...

- Enter the numbers 7 8 8 4 4 4 in this order.

GDV 130...

- Enter the numbers 8 0 9 5 in this order.





GDP 3100, GDP 3105, GDP 3200, GDP 3205, GDP 4200, GDP 4204, GDP 5100, GDP 5102, GDP 5120, GDP 6150

- Enter the numbers 1 9 9 9 in this order

SE 1102..., SE 1105..., SE 1106...

- Press the "STANDBY" button on the remote control handset until the key symbol disappears from the display of the recorder

SE 1200..., SE 1205..., SE 1206...

- Press the buttons "STANDBY" and "TIMER ON/OFF" simultaneously (Display "– – – –")
- Press the buttons     and "OK" in this order.

SE 1210

- Enter the numbers 8 0 9 5 in this order.

SE 1230

- Enter the numbers 1 9 9 9 in this order.

SE 1300..., SE 1305..., SE 1400..., SE 1405...

- Press the buttons   – + and **OK** on the remote control in this order.

SE 5102 SV, SE 5104 SV, SE 5106 HiFi, SE 6102 SV, SE 6104 SV, SE 6106 HiFi

- Press the "CODE" button on the remote control handset
- Enter the numbers 4 9 3 4 in this order and confirm with the "OK" button
- Press the "STANDBY" button or disconnect the video recorder from the mains

SE 7104 SV

- Press the "CODE" button on the remote control handset
- Enter the numbers 4 9 3 4 in this order and confirm with the "OK" button
- Press the "STANDBY" button or disconnect the video recorder from the mains







SE 7105

- Press the remote control buttons "STANDBY" and "SELECT" simultaneously until the key symbol disappears from the display of the recorder

SE 7106 HiFi

- Press the "CODE" button on the remote control handset
- Enter the numbers 4 9 3 4 in this order and confirm with the "OK" button
- Press the "STANDBY" button or disconnect the video recorder from the mains

SE 9100...

- Select the "AV" programme position on the TV set for playing back a recording
- Switch the video recorder on with the  button
- Call up the main menu with the "i INFO" button
- Select "MODE" with the   buttons and confirm with the "OK" button
- Select "CHILD LOCK" with the   buttons
- Select "OFF" with the  button and confirm with "OK"

SE 9102 SV, SE 9105 HiFi, SE 9106 HiFi/NIC

- Press the "STANDBY" button on the remote control handset until the key symbol disappears from the display



GV 8..., KV 8..., SE 8...

- Press the remote control buttons "STANDBY" and "SELECT" simultaneously until the key symbol disappears from the display of the recorder

TVR 3700

- Press and hold down the Stop button on the remote control handset and press the Play button on the video recorder
- Press the "STANDBY" button or disconnect the video recorder from the mains

TVR 3701, TVR 3705, TVR 3710, TVR 3720, TVR 3730

- Press the cursor buttons on the remote control handset in this order    





TVR 3735..., TVR 3740...

- Enter the numbers 7 0 3 8 in this order on the remote control handset

TVR 4500 and TVR 4510

- Switch the TVR off and disconnect it from the mains
- Remove the rear of the cabinet
- Disconnect the cable and pull the video recorder out of the cabinet towards the back
- Connect the video recorder to the mains and switch it on
- Interconnect the service test points on the keyboard control unit shortly
- Switch the video recorder off and disconnect it from the mains
- Push the video recorder into the cabinet from the back and connect the cable
- Refit the rear of the cabinet

TVR 5100, TVR 5130, TVR 5500

- Press the cursor buttons on the remote control handset in this order    

TVR 5510

- Switch the TVR off and disconnect it from the mains
- Remove the rear of the cabinet
- Disconnect the cable and pull the video recorder out of the cabinet towards the back
- Connect the video recorder to the mains and switch it on
- Interconnect the service test points on the keyboard control unit shortly
- Switch the video recorder off and disconnect it from the mains
- Push the video recorder into the cabinet from the back and connect the cable
- Refit the rear of the cabinet

TVR 5530

- Press the cursor buttons on the remote control handset in this order    

TVR 5540...

- Enter the numbers 7 0 3 8 in this order on the remote control handset

Jigs and Tools for Video Recorders (Part 1)

Designation	Part Number																		
		GV 819 M *	GV 8000 EURO	GV 8000 GB	GV 8000 SV/1	GV 8000 SV/2	GV 8000 SV/5	GV 8050 SV	GV 8300 EURO	GV 8300 SV	GV 8300 SV/5	GV 8400 EURO	GV 8400 GB	GV 8400 HiFi	GV 8400 HiFi/5	GV 8400 NiC 1	GV 8400 NiC 2	GV 8450 HiFi	
Test Cassette	75988 061 7000	•	•	•	•	•	•	•	•	•	•	•	•	•	•	•	•	•	•
Adapter	75987 262 7300	-	•	•	•	•	•	•	•	•	•	•	•	•	•	•	•	•	•
Tape Tension Adjustm` t handle+Pin	75988 002 2700	-	•	•	•	•	•	•	•	•	•	•	•	•	•	•	•	•	•
Torquemeter 600gf-cm	75987 262 7200	-	•	•	•	•	•	•	•	•	•	•	•	•	•	•	•	•	•
Adjustment Screwdriver	75987 262 8000	-	•	•	•	•	•	•	•	•	•	•	•	•	•	•	•	•	•
Nylon Gloves	com. available	•	•	•	•	•	•	•	•	•	•	•	•	•	•	•	•	•	•
Tentelometer	com. available	-	•	•	•	•	•	•	•	•	•	•	•	•	•	•	•	•	•
Headwheel Extractor	75988 002 3700	-	•	•	•	•	•	•	•	•	•	•	•	•	•	•	•	•	•

* see corresponding Service Manual Page 1-2

Designation	Part Number																		
		GV 27	GV 27 EURO	GV 27 VPS/5	GV 47	GV 47 VPS/5						SE 7100 SV	SE 7104 SV	SE 7105 HiFi	SE 7106 HiFi	SE 8100 SV	SE 8105 HiFi		
Test Cassette	75988 061 7000	•	•	•	•	•	•	•	•	•	•	•	•	•	•	•	•	•	•
Adapter	75987 262 7300	•	•	•	•	•	•	•	•	•	•	•	•	•	•	•	•	•	•
Tape Tension Adjustm` t handle+Pin	75988 002 2700	•	•	•	•	•	•	•	•	•	•	•	•	•	•	•	•	•	•
Torquemeter 600gf-cm	75987 262 7200	•	•	•	•	•	•	•	•	•	•	•	•	•	•	•	•	•	•
Adjustment Screwdriver	75987 262 8000	•	•	•	•	•	•	•	•	•	•	•	•	•	•	•	•	•	•
Nylon Gloves	com. available	•	•	•	•	•	•	•	•	•	•	•	•	•	•	•	•	•	•
Tentelometer	com. available	•	•	•	•	•	•	•	•	•	•	•	•	•	•	•	•	•	•
Headwheel Extractor	75988 002 3700	•	•	•	•	•	•	•	•	•	•	•	•	•	•	•	•	•	•

Designation	Part Number													
		GV 29...	GV 94...	GV 900...	GV 920 HiFi	GV 940...	GV 950 HiFi/NiC	GV 9000...	GV 9300...	GV 9400...	SE 9100 SV	SE 9102 SV	SE 9105 HiFi	SE 9106 HiFi/NiC
Test Cassette	75988 061 7000	•	•	•	•	•	•	•	•	•	•	•	•	•
Torque Cassette Meter	75988 047 1200	•	•	•	•	•	•	•	•	•	•	•	•	•
Torquemeter 600gf-cm	75981 311 3200	•	•	•	•	•	•	•	•	•	•	•	•	•
X-value Adjustment Tool	75988 047 1100	-	-	•	•	•	•	•	•	•	•	•	•	•
Tension Gauge	com. available	-	-	•	•	•	•	•	•	•	•	•	•	•
Screwdriver (slotted)	com. available	•	•	•	•	•	•	•	•	•	•	•	•	•
Nylon Gloves	com. available	•	•	•	•	•	•	•	•	•	•	•	•	•
Torque Screwdriver	com. available	•	•	•	•	•	•	•	•	•	•	•	•	•
Hexagon Box Wrench 5.5mm	com. available	-	-	•	•	•	•	•	•	•	•	•	•	•
Slide Gauge	com. available	•	•	•	•	•	•	•	•	•	•	•	•	•

Jigs and Tools for Video Recorders (Part 2)

Designation	Part Number	GV 1010 SV/1	GV 1030 HiFi	GV 3000 VPS...	GV 3004 PDC/EURO	GV 3005 VPS	GV 3006 VPS	GV 3010 SV...	GV 3015 SV	GV 3042 NIC	GV 3043 HiFi	GV 3044 NIC/EURO	GV 3045 HiFi	GV 3100 VPS...	GV 3105 VPS	GV 3106 VPS	GV 3110 SV...	GV 3115 SV	GV 3142 NIC	GV 3143 HiFi	GV 3145 HiFi	GV 3146 MULTI	GV 3147 HiFi
Test Cassette	75988 061 7000	●	●	●	●	●	●	●	●	●	●	●	●	●	●	●	●	●	●	●	●	●	●
Torque Cassette Meter	75988 047 1200	●	●	●	●	●	●	●	●	●	●	●	●	●	●	●	●	●	●	●	●	●	●
Torquemeter 600gf-cm	75981 311 3200	●	●	●	●	●	●	●	●	●	●	●	●	●	●	●	●	●	●	●	●	●	●
X-value Adjustment Tool	75988 047 1100	●	●	●	●	●	●	●	●	●	●	●	●	●	●	●	●	●	●	●	●	●	●
Tension Gauge	com. available	●	●	●	●	●	●	●	●	●	●	●	●	●	●	●	●	●	●	●	●	●	●
Screwdriver (slotted)	com. available	●	●	●	●	●	●	●	●	●	●	●	●	●	●	●	●	●	●	●	●	●	●
Nylon Gloves	com. available	●	●	●	●	●	●	●	●	●	●	●	●	●	●	●	●	●	●	●	●	●	●
Torque Screwdriver	com. available	●	●	●	●	●	●	●	●	●	●	●	●	●	●	●	●	●	●	●	●	●	●
Hexagon Box Wrench 5.5mm	com. available	●	●	●	●	●	●	●	●	●	●	●	●	●	●	●	●	●	●	●	●	●	●
Slide Gauge	com. available	●	●	●	●	●	●	●	●	●	●	●	●	●	●	●	●	●	●	●	●	●	●

Designation	Part Number	GV 3200 VPS	GV 3205 VPS	GV 3242 NIC/1	GV 3242 NIC/2	GV 3243 HiFi	GV 3245 HiFi	GV 3247 HiFi	GV 5052 NIC	GV 5053 HiFi	GV 5054 NIC/EURO	GV 5152 NIC	GV 5153 HiFi	GV 5253 HiFi	GV 6062 NIC	GV 6063 HiFi	GV 6065 HiFi	GV 6162 NIC	GV 6163 HiFi	GV 6165 HiFi	GV 6167 HiFi	
Test Cassette	75988 061 7000	●	●	●	●	●	●	●	●	●	●	●	●	●	●	●	●	●	●	●	●	●
Torque Cassette Meter	75988 047 1200	●	●	●	●	●	●	●	●	●	●	●	●	●	●	●	●	●	●	●	●	●
Torquemeter 600gf-cm	75981 311 3200	●	●	●	●	●	●	●	●	●	●	●	●	●	●	●	●	●	●	●	●	●
X-value Adjustment Tool	75988 047 1100	●	●	●	●	●	●	●	●	●	●	●	●	●	●	●	●	●	●	●	●	●
Tension Gauge	com. available	●	●	●	●	●	●	●	●	●	●	●	●	●	●	●	●	●	●	●	●	●
Screwdriver (slotted)	com. available	●	●	●	●	●	●	●	●	●	●	●	●	●	●	●	●	●	●	●	●	●
Nylon Gloves	com. available	●	●	●	●	●	●	●	●	●	●	●	●	●	●	●	●	●	●	●	●	●
Torque Screwdriver	com. available	●	●	●	●	●	●	●	●	●	●	●	●	●	●	●	●	●	●	●	●	●
Hexagon Box Wrench 5.5mm	com. available	●	●	●	●	●	●	●	●	●	●	●	●	●	●	●	●	●	●	●	●	●
Slide Gauge	com. available	●	●	●	●	●	●	●	●	●	●	●	●	●	●	●	●	●	●	●	●	●

Designation	Part Number	GV 6262 NIC	GV 6263 HiFi	GV 6265 HiFi	SE 1102 SV	SE 1105 HiFi	SE 1106 HiFi/NIC	SE 1200 SV	SE 1205 HiFi	SE 1206 HiFi/NIC	SE 1300 SV	SE 1305 HiFi	SE 1400 SV	SE 1405 HiFi/NIC
Test Cassette	75988 061 7000	●	●	●	●	●	●	●	●	●	●	●	●	●
Torque Cassette Meter	75988 047 1200	●	●	●	●	●	●	●	●	●	●	●	●	●
Torquemeter 600gf-cm	75981 311 3200	●	●	●	●	●	●	●	●	●	●	●	●	●
X-value Adjustment Tool	75988 047 1100	●	●	●	●	●	●	●	●	●	●	●	●	●
Tension Gauge	com. available	●	●	●	●	●	●	●	●	●	●	●	●	●
Screwdriver (slotted)	com. available	●	●	●	●	●	●	●	●	●	●	●	●	●
Nylon Gloves	com. available	●	●	●	●	●	●	●	●	●	●	●	●	●
Torque Screwdriver	com. available	●	●	●	●	●	●	●	●	●	●	●	●	●
Hexagon Box Wrench 5.5mm	com. available	●	●	●	●	●	●	●	●	●	●	●	●	●
Slide Gauge	com. available	●	●	●	●	●	●	●	●	●	●	●	●	●

Video

Jigs and Tools for TVR Combinations

Video

Designation	Part Number	TVR 3701 SV	TVR 3701 SV/FR	TVR 3705	TVR 3705 FR	TVR 3710	TVR 3710 FR	TVR 3710 GB	TVR 3720	TVR 3720 GB	TVR 3730 Text	TVR 3730 Text/FR	TVR 3730 Text/GB	TVR 3735 FR/TOP	TVR 3735/1 TOP	TVR 3735/2 TOP	TVR 3740 FR/TOP	TVR 3740 FT/GB	TVR 3740/1 TOP	TVR 3740/2 TOP	
		Test Cassette	75988 061 7000	●	●	●	●	●	●	●	●	●	●	●	●	●	●	●	●	●	●
Adapter	75987 262 7300	●	●	●	●	●	●	●	●	●	●	●	●	●	●	●	●	●	●	●	●
Tape Tension Adjustm` t handle+Pin	75988 002 2700	●	●	●	●	●	●	●	●	●	●	●	●	●	●	●	●	●	●	●	●
Torquemeter 600gf-cm	75987 262 7200	●	●	●	●	●	●	●	●	●	●	●	●	●	●	●	●	●	●	●	●
Adjustment Screwdriver	75987 262 8000	●	●	●	●	●	●	●	●	●	●	●	●	●	●	●	●	●	●	●	●
Headwheel Extractor	75988 002 3700	●	●	●	●	●	●	●	●	●	●	●	●	●	●	●	●	●	●	●	●
Screwdriver (slotted)	com. available	-	-	-	-	-	-	-	-	-	-	-	-	-	-	-	-	-	-	-	-
Nylon Gloves	com. available	●	●	●	●	●	●	●	●	●	●	●	●	●	●	●	●	●	●	●	●
Hexagon Box Wrench 5.5mm	com. available	-	-	-	-	-	-	-	-	-	-	-	-	-	-	-	-	-	-	-	-
Slide Gauge	com. available	-	-	-	-	-	-	-	-	-	-	-	-	-	-	-	-	-	-	-	-
Tentelometer	com. available	●	●	●	●	●	●	●	●	●	●	●	●	●	●	●	●	●	●	●	●

Designation	Part Number	TVR 5100	TVR 5100 Text (BA)	TVR 5100 FR	TVR 5100 GB	TVR 5120 FR	TVR 5130 FR	TVR 5130 Text	TVR 5130 Text/GB	TVR 5500	TVR 5500 FR	TVR 5530 Text	TVR 5530 Text/FR	TVR 5540 FR/TOP	TVR 5540 FT/GB	TVR 5540/1 TOP	TVR 5540/2 TOP	
		Test Cassette	75988 061 7000	●	●	●	●	●	●	●	●	●	●	●	●	●	●	●
Adapter	75987 262 7300	●	●	●	●	●	●	●	●	●	●	●	●	●	●	●	●	●
Tape Tension Adjustm` t handle+Pin	75988 002 2700	●	●	●	●	●	●	●	●	●	●	●	●	●	●	●	●	●
Torquemeter 600gf-cm	75987 262 7200	●	●	●	●	●	●	●	●	●	●	●	●	●	●	●	●	●
Adjustment Screwdriver	75987 262 8000	●	●	●	●	●	●	●	●	●	●	●	●	●	●	●	●	●
Headwheel Extractor	75988 002 3700	●	●	●	●	●	●	●	●	●	●	●	●	●	●	●	●	●
Screwdriver (slotted)	com. available	-	-	-	-	-	-	-	-	-	-	-	-	●	●	●	●	●
Nylon Gloves	com. available	●	●	●	●	●	●	●	●	●	●	●	●	●	●	●	●	●
Hexagon Box Wrench 5.5mm	com. available	-	-	-	-	-	-	-	-	-	-	-	-	●	●	●	●	●
Slide Gauge	com. available	-	-	-	-	-	-	-	-	-	-	-	-	●	●	●	●	●
Tentelometer	com. available	●	●	●	●	●	●	●	●	●	●	●	●	●	●	●	●	●

Contents: Camcorders

Modulators and Power Supply Units.....4.2

Accumulators 4.4

Back-up Batteries and Remote Control Transmitters..... 4.6

Sockets and Filter Threads 4.8

Service Manuals4.10

- Camcorders 4.10
- Accessories..... 4.12
- Cameras 4.12

To be better readable part numbers are shown with two spaces.
 For ordering spare parts please indicate part numbers as **twelve-figure number** without spaces.

Modulators and Power Supply Units

Camcorder	Modulator	Part Number	Power Supply	Part Number
VS-C 20	—	—	NA 50	75987 430 0400
VS-C 30	—	—	NA 50	75987 430 0400
VS-C 35	M 45	75987 482 8200	NA 75 A	75987 579 7000
VS-C 40	M 60	sold out	NA 60	75987 457 0300
VS-C 45	M 45	75987 482 8200	NA 80	75987 513 0900
VS-C 46	M 45	75987 482 8200	NA 75	75987 550 6000
VS-C 50	M 50	75987 430 0500	NA 50	75987 430 0400
VS-C 55	M 45	75987 482 8200	NA 75	75987 550 6000
VS-C 60	M 60	sold out	NA 60	75987 457 0300
VS-C 70	M 60	sold out	NA 80	75987 513 0900
S-VS-C 75	M 45	75987 482 8200	NA 75	75987 550 6000
S-VS-C 80	M 60	sold out	NA 80	75987 513 0900
S-VS-C 85	M 45	75987 482 8200	NA 80	75987 513 0900
VS 120	in Tuner/Timer	—	NA 120	75987 331 9100
VS 150	M 150	sold out	NA 150	75987 356 3800
VS 160	in Power Supply	—	NA 160	75987 249 7200
VS 170	in Power Supply	—	NA 170	75907 710 5100
S-VS 180	in Power Supply	—	NA 170	75907 710 5100
VS 4-8	in VS 4-8	—	NA 8	75987 527 8800
VS 8000	M 8	75987 527 8900	NA 8	75987 527 8800
VS 8100	M 81	75987 553 1100	NA 8-1	75987 553 1000
VS 8150	M 81	75987 553 1100	NA 8-1 A	75987 580 4000
VS 8250	M 81	75987 553 1100	NA 8-2	75987 580 1400
VS 8300	M 8	75987 527 8900	NA 8	75987 527 8800
VS 8320	M 81	75987 553 1100	NA 8	75987 527 8800
VS 8500	M 81	75987 553 1100	NA 8	75987 527 8800
VS 8800	M 81	75987 553 1100	NA 8-1	75987 553 1000
LC 125 C	M 45	75987 482 8200	NA 75	75987 550 6000
LC 145 E	M 81	75987 553 1100	NA 8	75987 527 8800
LC 175 HE	M 81	75987 553 1100	NA 8-1 A	75987 580 4000
LC 180 HE	M 81	75987 553 1100	NA 8	75987 527 8800
LC 210 C	M 45	75987 482 8200	NA 75 B	75981 277 9800
LC 215C	M 45	75987 482 8200	NA 75 B	75981 277 9800
LC 225C	M 45	75987 482 8200	NA 75 B	75981 277 9800
LC 230 E	M 81	75987 553 1100	NA 8-2	75987 580 1400
LC 232 E	M 81	75987 553 1100	NA 8-1	75987 553 1000
LC 235 E	M 81	75987 553 1100	NA 8-1	75987 553 1000
LC 240 E	M 81	75987 553 1100	NA 8-3	75981 281 5100
LC 255 SC	M 45	75987 482 8200	NA 75 A	75987 579 7000
LC 280 HE	M 81	75987 553 1100	NA 8-4	75981 293 4000
LC 285 HE	M 81	75987 553 1100	NA 8	75987 527 8800
LC 290 N	M 45	75987 482 8200	NA 190 A	75981 281 3000
LC 295 SN	M 45	75987 482 8200	NA 190 A	75981 281 3000
LC 310 C	M 45	75987 482 8200	NA 85	75981 295 9600
LC 320 C	M 45	75987 482 8200	NA 90	75981 304 2700
LC 330 E	M 81	75987 553 1100	NA 8-3	75981 281 5100
LC 335 E	M 81	75987 553 1100	NA 8-3	75981 281 5100
LC 345 E	M 81	75987 553 1100	NA 8-3	75981 281 5100
LC 355 SC	M 45	75987 482 8200	NA 90	75981 304 2700
LC 360 SC	M 45	75987 482 8200	NA 85	75981 295 9600
LC 375 HE	M 81	75987 553 1100	NA 8-1	75987 553 1000
LC 380 HE	M 81	75987 553 1100	NA 8-4	75981 293 4000

Camcorder	Modulator	Part Number	Power Supply	Part Number
LC 400 C	M 45	75987 482 8200	NA 95	75981 320 2700
LC 410 C	M 45	75987 482 8200	NA 95	75981 320 2700
LC 435 E	M 81	75987 553 1100	NA 8-3 *	75981 281 5100
LC 445 E	M 81	75987 553 1100	NA 8-3 *	75981 281 5100
LC 450 SC	M 45	75987 482 8200	NA 96	75981 332 6400
LC 460 SC	M 45	75987 482 8200	NA 96	75981 332 6400
LC 475 HE	M 81	75987 553 1100	NA 8-3 *	75981 281 5100
LC 485 HE	M 81	75987 553 1100	NA 8-1	75987 553 1000
LC 500 C	M 45	75987 482 8200	NA 96	75981 332 6400
LC 535 E	M 81	75987 553 1100	NA-L 1	75981 335 1200
LC 550 SC	M 45	75987 482 8200	NA 96	75981 332 6400
LC 560 SC	M 45	75987 482 8200	NA 96	75981 332 6400
LC 575 E	M 81	75987 553 1100	NA-L 1	75981 335 1200
LC 600 C	M 45	75987 482 8200	NA 96	75981 332 6400
LC 610 C	M 45	75987 482 8200	NA 96	75981 332 6400
LC 635 E	M 81	75987 553 1100	NA 8-5	75981 345 0600
LC 645 E	M 81	75987 553 1100	NA 8-5	75981 345 0600
LC 650 SC	–	–	NA 96	75981 332 6400
LC 675 HE	M 81	75987 553 1100	NA 8-6	75981 353 4800
LC 685 HE	M 81	75987 553 1100	NA 8-6	75981 353 4800
LC 695 SN	M 45	75987 482 8200	NA 190B	75981 348 9000
LC 700 C	M 45	75987 482 8200	NA 96	75981 332 6400
LC 735 E	M 81	75987 553 1100	NA 8-7	75981 355 0400
LC 750 SC	–	–	NA 96	75981 332 6400
LC 760 SC	–	–	NA 96	75981 332 6400
LC 775 HE	M 81	75987 553 1100	NA 8-72	75981 354 6400
LC 785 HE	M 81	75987 553 1100	NA 8-71	75981 354 0200
LC 800 C	–	–	NA 97	75981 361 7600
LC 835 E	M 81	75987 553 1100	NA-L 98	75981 365 1000
LC 875 HE	M 81	75987 553 1100	NA-L 98	75981 365 1000
LC 885 HE	M 81	75987 553 1100	NA-L 98	75981 365 1000
LC 900 C	–	–	NA 99	75981 370 0000
LC 935 E	M 81	75987 553 1100	NA-L 98	75981 365 1000
LC 975 HE	M 81	75987 553 1100	NA-L 98	75981 365 1000
LC 1000 VC	–	–	NA 99	75981 370 0000
LC 1150 VC	–	–	NA 99	75981 370 0000
LC 3000 E	M 81	75987 553 1100	NA-L 98	75981 365 1000
LC 3100 HE	–	–	NA-L 98	75981 365 1000
LC 5000 HE	M 81	75987 553 1100	NA-L 98	75981 365 1000
LC-D 80 E	M 81	75987 553 1100	NA-L 1	75981 335 1200
LC-D 100 E	M 81	75987 553 1100	NA-L 2	75981 338 0700
LC-D 200 HE	M 81	75987 553 1100	NA-L 98	75981 365 1000
LC-D 300 HE	M 81	75987 553 1100	NA-L 98	75981 365 1000
LCD 6000 HE	M 81	75987 553 1100	NA-L 98	75981 365 1000
LCD 6100 HE	–	–	NA-L 98	75981 365 1000
DLC 1	–	–	NA-D 1	75981 358 0000
DLC 10	–	–	NA-D 10	75981 368 4500
DLC 20	–	–	NA-L 11	75981 369 8000
DLC 1000	–	–	NA-D1000	75981 379 0000
DLC 1500	–	–	NA-D1000	75981 379 0000
DLC 2000	–	–	NA-D2000	75981 385 7100

* is optionally replaced by NA-L 1

Accumulators

Camcorder	Incl.	Data	Part Number	Optional 2nd Accumulator
VS-C 20	BP 20	9,6V/450mAh	75987 447 0800	BP 21, BP 60, BP 80
VS-C 30	BP 20	9,6V/450mAh	75987 447 0800	BP 21, BP 60, BP 80
VS-C 35	BP 65	6V/1200mAh	75987 568 8700	BP 65, BP 70
VS-C 40	BP 60	9,6V/1100mAh	75987 457 0200	BP 21, BP 60, BP 80
VS-C 45	BP 60	9,6V/1100mAh	75987 457 0200	BP 21, BP 60, BP 80
VS-C 46	BP 65	6V/1200mAh	75987 568 8700	BP 65, BP 70
VS-C 50	BP 51	9,6V/1100mAh	75987 430 0700	BP 21, BP 51, BP 52, BP 60, BP 80
VS-C 55	BP 65	6V/1200mAh	75987 568 8700	BP 65, BP 70
VS-C 60	BP 60	9,6V/1100mAh	75987 457 0200	BP 21, BP 60, BP 80
VS-C 70	BP 60	9,6V/1100mAh	75987 457 0200	BP 21, BP 60, BP 80
S-VS-C 75	BP 65	6V/1200mAh	75987 568 8700	BP 65, BP 70
S-VS-C 80	BP 80	9,6V/1400mAh	75987 513 0700	BP 21, BP 60, BP 80
S-VS-C 85	BP 80	9,6V/1400mAh	75987 513 0700	BP 21, BP 60, BP 80
VS 120	BP 121	12V/1000mAh	replacement BP 122	BP 121, BP 122, BP 123
VS 150	BP 151	12V/800mAh	75987 356 6000	BP 151, BP 152
VS 160	BP 122	12V/2000mAh	75987 331 9200	BP 121, BP 122, BP 123
VS 170	BP 122	12V/2000mAh	75987 331 9200	BP 121, BP 122, BP 123
S-VS 180	BP 122	12V/2000mAh	75987 331 9200	BP 121, BP 122, BP 123
VS 4-8	BP 8-1	6V/1000mAh	75987 527 9000	BP 8-1, BP 8-2, BP 8-3, BP 8-4, BP 8-5, BP 8-6
VS 8000	BP 8-1	6V/1000mAh	75987 527 9000	BP 8-1, BP 8-2, BP 8-3, BP 8-4, BP 8-5, BP 8-6
VS 8100	BP 8-4	6V/1400mAh	75987 553 2200	BP 8-1, BP 8-2, BP 8-3, BP 8-4, BP 8-5, BP 8-6
VS 8150	BP 8-4	6V/1400mAh	75987 553 2200	BP 8-1, BP 8-2, BP 8-3, BP 8-4, BP 8-5, BP 8-6
VS 8250	BP 8-4	6V/1400mAh	75987 553 2200	BP 8-1, BP 8-2, BP 8-3, BP 8-4, BP 8-5, BP 8-6
VS 8300	BP 8-1	6V/1000mAh	75987 527 9000	BP 8-1, BP 8-2, BP 8-3, BP 8-4, BP 8-5, BP 8-6
VS 8320	BP 8-1	6V/1000mAh	75987 527 9000	BP 8-1, BP 8-2, BP 8-3, BP 8-4, BP 8-5, BP 8-6
VS 8500	BP 8-2	6V/2000mAh	75987 525 8300	BP 8-1, BP 8-2, BP 8-3, BP 8-4, BP 8-5, BP 8-6
VS 8800	BP 8-5	6V/1800mAh	replacement BP 8-3	BP 8-1, BP 8-2, BP 8-3, BP 8-4, BP 8-5, BP 8-6
LC 125 C	BP 65	6V/1200mAh	75987 568 8700	BP 65, BP 70
LC 145 E	BP 8-1	6V/1000mAh	75987 527 9000	BP 8-1, BP 8-2, BP 8-3, BP 8-4, BP 8-5, BP 8-6
LC 175 HE	BP 8-5	6V/1800mAh	replacement BP 8-3	BP 8-1, BP 8-2, BP 8-3, BP 8-4, BP 8-5, BP 8-6
LC 180 HE	BP 8-1	6V/1000mAh	75987 527 9000	BP 8-1, BP 8-2, BP 8-3, BP 8-4, BP 8-5, BP 8-6
LC 210 C	BP 65	6V/1200mAh	75987 568 8700	BP 65, BP 70
LC 215 C	BP 65	6V/1200mAh	75987 568 8700	BP 65, BP 70
LC 225 C	BP 65	6V/1200mAh	75987 568 8700	BP 65, BP 70
LC 230 E	BP 8-4	6V/1400mAh	75987 553 2200	BP 8-1, BP 8-2, BP 8-3, BP 8-4, BP 8-5, BP 8-6
LC 232 E	BP 8-1	6V/1000mAh	75987 527 9000	BP 8-1, BP 8-2, BP 8-3, BP 8-4, BP 8-5, BP 8-6
LC 235 E	BP 8-6	6V/1200mAh	75981 283 9500	BP 8-1, BP 8-2, BP 8-3, BP 8-4, BP 8-5, BP 8-6
LC 240 E	BP 8-6	6V/1200mAh	75981 283 9500	BP 8-1, BP 8-2, BP 8-3, BP 8-4, BP 8-5, BP 8-6
LC 255 SC	BP 65	6V/1200mAh	75987 568 8700	BP 65, BP 70
LC 280 HE	BPL 8-7	7,2V/1000mAh	75981 291 7800	BPL 8-4, BPL 8-7
LC 285 HE	BP 8-6	6V/1200mAh	75981 283 9500	BP 8-1, BP 8-2, BP 8-3, BP 8-4, BP 8-5, BP 8-6
LC 290 N	BP 124	12V/2000mAh	75913 210 0000	BP 124
LC 295 SN	BP 124	12V/2000mAh	75913 210 0000	BP 124
LC 310 C	BP 65	6V/1200mAh	75987 568 8700	BP 65, BP 70
LC 320 C	BP 75	4,8V/1300mAh	75981 304 2600	BP 74, BP 75, BP 85
LC 330 E	BP 8-1	6V/1000mAh	75987 527 9000	BP 8-1, BP 8-2, BP 8-3, BP 8-4, BP 8-5, BP 8-6
LC 335 E	BP 8-1	6V/1000mAh	75987 527 9000	BP 8-1, BP 8-2, BP 8-3, BP 8-4, BP 8-5, BP 8-6
LC 345 E	BP 8-1	6V/1000mAh	75987 527 9000	BP 8-1, BP 8-2, BP 8-3, BP 8-4, BP 8-5, BP 8-6
LC 355 SC	BP 75	4,8V/1300mAh	75981 304 2600	BP 74, BP 75, BP 85
LC 360 SC	BP 65	6V/1200mAh	75987 568 8700	BP 65, BP 70 *
LC 375 HE	BP 8-6	6V/1200mAh	75981 283 9500	BP 8-1, BP 8-2, BP 8-3, BP 8-4, BP 8-5, BP 8-6
LC 380 HE	BPL 8-7	7,2V/1000mAh	75981 291 7800	BPL 8-4, BPL 8-7
LC 400 C	BP 74	4,8V/1200mAh	75981 320 2600	BP 74, BP 75, BP 85
LC 410 C	BP 74	4,8V/1200mAh	75981 320 2600	BP 74, BP 75, BP 85
LC 435 E	BP 8-1	6V/1000mAh	75987 527 9000	BP 8-1, BP 8-2, BP 8-3, BP 8-4, BP 8-5, BP 8-6
LC 445 E	BP 8-1	6V/1000mAh	75987 527 9000	BP 8-1, BP 8-2, BP 8-3, BP 8-4, BP 8-5, BP 8-6

Camcorder	Incl.	Data	Part Number	Optional 2nd Accumulator
LC 450 SC	BP 74	4,8V/1200mAh	75981 320 2600	BP 74, BP 75, BP 85
LC 460 SC	BP 75	4,8V/1300mAh	75981 304 2600	BP 74, BP 75, BP 85
LC 475 HE	BP 8-1	6V/1000mAh	75987 527 9000	BP 8-1, BP 8-2, BP 8-3, BP 8-4, BP 8-5, BP 8-6
LC 485 HE	BP 8-6	6V/1200mAh	75981 283 9500	BP 8-1, BP 8-2, BP 8-3, BP 8-4, BP 8-5, BP 8-6
LC 500 C	BP 74	4,8V/1200mAh	75981 320 2600	BP 74, BP 75, BP 85
LC 535 E	BP 8-1	6V/1000mAh	75987 527 9000	BP 8-1, BP 8-2, BP 8-3, BP 8-4, BP 8-5, BP 8-6
LC 550 SC	BP 74	4,8V/1200mAh	75981 320 2600	BP 74, BP 75, BP 85
LC 560 SC	BP 74	4,8V/1200mAh	75981 320 2600	BP 74, BP 75, BP 85
LC 575 E	BP 8-1	6V/1000mAh	75987 527 9000	BP 8-1, BP 8-2, BP 8-3, BP 8-4, BP 8-5, BP 8-6
LC 600 C	BP 74	4,8V/1200mAh	75981 320 2600	BP 74, BP 75, BP 85
LC 610 C	BP 74	4,8V/1200mAh	75981 320 2600	BP 74, BP 75, BP 85
LC 635 E	BP 8-8	6V/800mAh	75981 352 5000	BP 8-1, BP 8-2, BP 8-3, BP 8-4, BP 8-5, BP 8-6
LC 645 E	BP 8-8	6V/800mAh	75981 352 5000	BP 8-1, BP 8-2, BP 8-3, BP 8-4, BP 8-5, BP 8-6
LC 650 SC	BP 74	4,8V/1200mAh	75981 320 2600	BP 74, BP 75, BP 85
LC 675 HE	BPL 8-8	7,2V/1350mAh	75981 353 4900	BPL 8-8, BPL 8-10, BPL 8-12
LC 685 HE	BPL 8-8	7,2V/1350mAh	75981 353 4900	BPL 8-8, BPL 8-10, BPL 8-12
LC 695 SN	BP 124	12V/2000mAh	75913 210 0000	BP 124
LC 700 C	BP 74	4,8V/1200mAh	75981 320 2600	BP 74, BP 75, BP 85
LC 735 E	BP 8-8	6V/800mAh	75981 352 5000	BP 8-1, BP 8-2, BP 8-3, BP 8-4, BP 8-5, BP 8-6
LC 750 SC	BP 74	4,8V/1200mAh	75981 320 2600	BP 74, BP 75, BP 85
LC 760 SC	BP 74	4,8V/1200mAh	75981 320 2600	BP 74, BP 75, BP 85
LC 775 HE	BPL 8-10	7,2V/700mAh	75981 354 6500	BPL 8-8, BPL 8-10, BPL 8-12
LC 785 HE	BPL 8-8	7,2V/1350mAh	75981 353 4900	BPL 8-8, BPL 8-10, BPL 8-12
LC 800 C	BP 74	4,8V/1200mAh	75981 358 0300	BP 74, BP 75, BP 85
LC 835 E	BPL8-10	7,2V/700mAh	75981 354 6500	BPL 8-8, BPL 8-10, BPL 8-12
LC 875 HE	BPL8-10	7,2V/700mAh	75981 354 6500	BPL 8-8, BPL 8-10, BPL 8-12
LC 885 HE	BPL8-10	7,2V/700mAh	75981 354 6500	BPL 8-8, BPL 8-10, BPL 8-12
LC 900 C	BPL 99	7,2V/1300mAh	75981 371 0900	BPL 99
LC 935 E	BPL 8-10	7,2V/700mAh	75981 354 6500	BPL 8-8, BPL 8-10, BPL 8-12
LC 975 HE	BPL 8-10	7,2V/700mAh	75981 354 6500	BPL 8-8, BPL 8-10, BPL 8-12
LC 1000 VC	BPL 99	7,2V/1300mAh	75981 371 0900	BPL 99
LC 1150 VC	BPL 99	7,2V/1300mAh	75981 371 0900	BPL 99
LC 3000 E	BPL 8-10	7,2V/700mAh	75981 354 6500	BPL 8-8, BPL 8-10, BPL 8-12
LC 3100 HE	BPL8-10	7,2V/700mAh	75981 354 6500	BPL 8-8, BPL 8-10, BPL 8-12
LC 5000 HE	BPL 8-10	7,2V/700mAh	75981 354 6500	BPL 8-8, BPL 8-10, BPL 8-12
LC-D 80 E	BP 8-4	6V/1400mAh	75987 553 2200	BP 8-1, BP 8-2, BP 8-3, BP 8-4, BP 8-5, BP 8-6
LC-D 100 E	BP 8-4	6V/1400mAh	75987 553 2200	BP 8-1, BP 8-2, BP 8-3, BP 8-4, BP 8-5, BP 8-6
LC-D 200 HE	BPL8-10	7,2V/700mAh	75981 354 6500	BPL 8-8, BPL 8-10, BPL 8-12
LC-D 300 HE	BPL 8-10	7,2V/700mAh	75981 356 5200	BPL 8-8, BPL 8-10, BPL 8-12
LCD 6000 HE	BPL 8-10	7,2V/700mAh	75981 354 6500	BPL 8-8, BPL 8-10, BPL 8-12
LCD 6100 HE	BPL 8-10	7,2V/700mAh	75981 354 6500	BPL 8-8, BPL 8-10, BPL 8-12
DLC 1	BPL 97	7,2V/1255mAh	75981 358 0100	BPL 97
DLC 10	BPL 98	7,2V/800mAh	75981 368 4700	BPL 98
DLC 20	BPL 98	7,2V/800mAh	75981 368 4700	BPL 98
DLC 1000	BPL 1000	7,2V/800mAh	75981 388 2500	BPL 1000
DLC 1500	BPL 1000	7,2V/800mAh	75981 388 2500	BPL 1000
DLC 2000	BPL 2000	7,4/1100mAh	75981 385 7200	BPL 2000

Extra accessory: BP 8-3	6V/2400mAh	75909 310 0000
Extra accessory: BP 52	9,6V/1400mAh	75987 430 1200
Extra accessory: BP 70	6V/2400mAh	75909 610 0000
Extra accessory: BP 85	4,8V/2600mAh	75913 510 0000
Extra accessory: BP 123	12V/2300mAh	75909 710 0000
Extra accessory: BPL 8-4	7,2V/1200mAh	75981 291 7800
Extra accessory: BPL 8-12	7,2V/1500mAh	75981 356 5200

*When using the BP 70 accumulator the battery compartment of LC 360 SC cannot be closed completely.

Back-up Batteries and Remote Control Transmitters

Camcorder	Back-up Battery	RC Transmitter	Part Number	Transmitter Battery
VS-C 20	-	-	-	-
VS-C 30	-	-	-	-
VS-C 35	CR 2032	-	-	-
VS-C 40	LR 1130	-	-	-
VS-C 45	LR 1130	-	-	-
VS-C 46	CR 2032	-	-	-
VS-C 50	-	-	-	-
VS-C 55	CR 2032	-	-	-
VS-C 60	LR 1130	-	-	-
VS-C 70	LR 1130	-	-	-
S-VS-C 75	CR 2032	-	-	-
S-VS-C 80	LR 1130	-	-	-
S-VS-C 85	CR 2032	-	-	-
VS 150	-	-	-	-
VS 160	3 x Micro (AAA)	-	-	-
VS 170	LR 1130	-	-	-
S-VS 180	LR 1130	-	-	-
VS 8000	CR 2025	-	-	-
VS 8100	CR 2025	-	-	-
VS 8150	CR 2025	RC 8-2	75987 580 0200	2 x Mignon
VS 8250	CR 2025	RC 8-2	75987 580 0200	2 x Mignon
VS 8300	CR 2025	-	-	-
VS 8320	CR 2025	-	-	-
VS 8500	CR 2025	-	-	-
VS 8800	CR 2025	RC 8-1	75987 559 0200	2 x Mignon
LC 125 C	CR 2032	-	-	-
LC 145 E	CR 2025	RC 8-4	75981 273 0100	2 x Mignon
LC 175 HE	CR 2025	RC 8-3	75987 585 0700	2 x Mignon
LC 180 HE	CR 2025	RC 8-5	75981 271 1900	2 x Mignon
LC 210 C	CR 2032	-	-	-
LC 215 C	CR 2032	-	-	-
LC 225 C	CR 2032	-	-	-
LC 230 E	CR 2025	RC 8-6	75987 585 0700	CR 2025
LC 232 E	CR 2025	-	-	-
LC 235 E	CR 2025	RC 8-4	75981 273 0100	2 x Mignon
LC 240 E	CR 2025	RC 8-7	75981 282 1500	2 x Mignon
LC 255 SC	CR 2032	-	-	-
LC 280 HE	CR 2025	RC 8-9	75981 291 6600	CR 2025
LC 285 HE	CR 2025	RC 8-8	75981 284 1000	CR 2025
LC 290 N	Lithium battery *	-	-	-
LC 295 SN	Lithium battery *	-	-	-
LC 310 C	CR 2032	-	-	-
LC 320 C	CR 2032	-	-	-
LC 330 E	CR 2025	-	-	-
LC 335 E	CR 2025	RC 8-4	75981 273 0100	2 x Mignon
LC 345 E	CR 2025	RC 8-4	75981 273 0100	2 x Mignon
LC 355 SC	CR 2032	-	-	-
LC 360 SC	Lithium battery *	-	-	-
LC 375 HE	CR 2025	RC 8-7	75981 282 1500	2 x Mignon
LC 380 HE	CR 2025	RC 8-9	75981 291 6600	CR 2025

Camcorder	Back-up Battery	RC Transmitter	Part Number	Transmitter Battery
LC 400 C	Lithium battery *	–	–	–
LC 410 C	Lithium battery *	–	–	–
LC 435 E	CR 2025	–	–	–
LC 445 E	CR 2025	RC 8-11	75981 328 0500	2 x Mignon
LC 450 SC	Lithium battery *	–	–	–
LC 460 SC	Lithium battery *	–	–	–
LC 475 HE	CR 2025	RC 8-11	75981 328 0500	2 x Mignon
LC 485 HE	CR 2025	RC 8-10	75981 322 0700	2 x Mignon
LC 500 C	Lithium battery *	–	–	–
LC 535 E	CR 2025	RC 8-11	75981 328 0500	2 x Mignon
LC 550 SC	VL 2020 *	RC 500	75981 342 3800	CR 2025
LC 560 SC	VL 2330 *	RC 500	75981 342 3800	CR 2025
LC 575 E	CR 2025	RC 8-11	75981 328 0500	2 x Mignon
LC 600 C	VL 2330/1HF *	–	–	–
LC 610 C	VL 2020/1HF *	RC 500	75981 342 3800	CR 2025
LC 635 E	CR 2025	–	–	–
LC 645 E	CR 2025	RC 6E	75981 346 0400	2 x Mignon
LC 650 SC	VL 2330/1HF *	RC 500	75981 342 3800	CR 2025
LC 675 HE	CR 2025	–	–	–
LC 685 HE	CR 2025	RC 6HE	75981 351 0500	2 x Mignon
LC 695 SN	VL 2020 *	–	–	–
LC 700 C	VL 2330/1HF *	–	–	–
LC 735 E	CR 2025	RC 6E	75981 346 0400	2 x Mignon
LC 750 SC	VL 2020/1HF *	RC 500	75981 342 3800	CR 2025
LC 760 SC	VL 2020/1HF *	RC 500	75981 342 3800	CR 2025
LC 775 HE	CR 2025	RC 8-11	75981 328 0500	2 x Mignon
LC 785 HE	CR 2025	RC 6HE	75981 351 0500	2 x Mignon
LC 800 C	ML 2020 *	–	–	–
LC 835 E	CR 2025	RC 8-11	75981 328 0500	2 x Mignon
LC 875 HE	CR 2025	RC 8-11	75981 328 0500	2 x Mignon
LC 885 HE	CR 2025	RC 6HE	75981 351 0500	2 x Mignon
LC 900 C	ML 2020 *	–	–	–
LC 935 E	CR 2025	–	–	–
LC 975 HE	CR 2025	RC 8-11	75981 328 0500	2 x Mignon
LC 1000 VC	CR 2025	–	–	–
LC 1150 VC	CR 2025	–	–	–
LC 3000 E	CR 2025	RC 8-11	75981 328 0500	2 x Mignon
LC 3100 HE	VL 2020 *	RC 8-11	75981 328 0500	2 x Mignon
LC 5000 HE	CR 2025	RC 8-11	75981 328 0500	2 x Mignon
LC-D 80 E	CR 2025	RC 8-11	75981 328 0500	2 x Mignon
LC-D 100 E	CR 2025	RC 8-11	75981 328 0500	2 x Mignon
LC-D 200 HE	CR 2025	RC 8-11	75981 328 0500	2 x Mignon
LC-D 300 HE	CR 2025	RC 8-11	75981 373 1200	2 x Mignon
LCD 6000 HE	CR 2025	RC 8-11	75981 328 0500	2 x Mignon
LCD 6100 HE	VL 2020 *	RC 8-11	75981 373 1200	2 x Mignon
DLC 1	VL 2020/1HF *	RC 700	75981 357 4300	CR 2025
DLC 10	VL 2020/1HF *	RC 10	75981 368 2200	CR 2025
DLC 20	VSB0407 *	TP 70 V	75981 369 8600	2 x Mignon
DLC 1000	ML 920 S *	TP 72 V	75981 357 4300	CR 2025
DLC 1500	ML 920 S *	TP 72 V	75981 357 4300	CR 2025
DLC 2000	CR 2025	TP 71 V	75981 385 7000	CR 2025
DMC 5100	CR 1220			
DMC 5200	CR 1220			

* Soldered into the camcorder

Camcorder

Sockets and Filter Threads

Camcorder	Socket		Signal		S-Video		Video		Audio (Stereo)		RC (REC)		Edit Bus		Micro (Mono)		Earphones		Filter Thread		
	IEEE 1394	Jack	Digital Video	Digital Video	Hosiden	10-pol AV/S	BNC	1 x Cinch	10-pol AV/S	8-pin Movie	8-pin Movie	4-pin Jack	4-pin Jack	1 x Cinch	2 x Cinch	2.5mm Jack	2.5mm Jack	3.5mm Jack	10-pin Socket	10-pin Socket	
VS-C 20																					-
VS-C 30																					49 mm
VS-C 35																					43 mm
VS-C 40																					49 mm
VS-C 45																					49 mm
VS-C 46																					43 mm
VS-C 50																					49 mm
VS-C 55																					27 mm
VS-C 60																					49 mm
VS-C 70																					49 mm
S-VS-C 75																					43 mm
S-VS-C 80																					49 mm
S-VS-C 85																					49 mm
VS 120																					-
VS 150																					46 mm
VS 160																					49 mm
VS 170																					49 mm
S-VS 180																					55 mm
VS 4-8																					-
VS 8000																					46 mm
VS 8100																					46 mm
VS 8150																					46 mm
VS 8250																					46 mm
VS 8300																					46 mm
VS 8320																					37/46 mm
VS 8500																					52 mm
VS 8800																					46 mm
LC 125 C																					37 mm
LC 145 E																					37 mm
LC 175 HE																					46 mm
LC 180 HE																					37 mm
LC 210 C																					49 mm
LC 215 C																					49 mm
LC 225 C																					37 mm
LC 230 E																					46 mm
LC 232 E																					37 mm
LC 235 E																					37 mm
LC 240 E																					37 mm
LC 255 SC																					37 mm
LC 280 HE																					37 mm
LC 285 HE																					52 mm
LC 290 N																					49 mm
LC 295 SN																					49 mm
LC 310 C																					49 mm
LC 320 C																					37 mm
LC 330 E																					37 mm
LC 335 E																					-
LC 345 E																					37 mm
LC 355 SC																					37 mm
LC 360 SC																					43 mm
LC 375 HE																					37 mm
LC 380 HE																					37 mm

Camcorder

Camcorder	Socket		Signal		Hosiden	10-pol AV/S	BNC	1 x Cinch	10-pol AV/S	8-pin Movie	8-pin Movie	4-pin Jack	4-pin Jack	1 x Cinch	2 x Cinch	2.5mm Jack	2.5mm Jack	5-pin Edit	11-pin Edit	2.5mm Jack	2.5mm Jack	3.5mm Jack	3.5mm Jack	10-pin Socket	10-pin Socket	Filter Thread		
	IEEE 1394	Jack	Digital Video	Digital Video																							S-Video	S-Video
LC 400 C																											37 mm	
LC 410 C																												37 mm
LC 435 E																											37 mm	
LC 445 E																											37 mm	
LC 450 SC																											37 mm	
LC 460 SC																											37 mm	
LC 475 HE																											37 mm	
LC 485 HE																											37 mm	
LC 500 C																											37 mm	
LC 535 E																											37 mm	
LC 550 SC																											43 mm	
LC 560 SC																											43 mm	
LC 575 E																											37 mm	
LC 600 C																											43 mm	
LC 610 C																											43 mm	
LC 635 E																											37 mm	
LC 645 E																											37 mm	
LC 650 SC																											43 mm	
LC 675 HE																											37 mm	
LC 685 HE																											52 mm	
LC 695 SN																											49 mm	
LC 700 C																											43 mm	
LC 735 E																											37 mm	
LC 750 SC																											43 mm	
LC 760 SC																											43 mm	
LC 775 HE																											37 mm	
LC 785 HE																											52 mm	
LC 800 C																											43 mm	
LC 835 E																											37 mm	
LC 875 HE																											37 mm	
LC 885 HE																											52 mm	
LC 900 C																											43 mm	
LC 935 E																											37 mm	
LC 975 HE																											37 mm	
LC 1000 VC																											43 mm	
LC 1150 VC																											43 mm	
LC 3000 E																											37 mm	
LC 3100 HE																											37 mm	
LC 5000 HE																											37 mm	
LC-D 80 E																											52 mm	
LC-D 100 E																											37 mm	
LC-D 200 HE																											37 mm	
LC-D 300 HE																											37 mm	
LCD 6000 HE																											37 mm	
LCD 6100 HE																											37 mm	
DLC 1																											30,5 mm	
DLC 10																											43 mm	
DLC 20																											43 mm	
DLC 1000																											43 mm	
DLC 1500																											43 mm	
DLC 2000																											37 mm	

1) Built-in loudspeaker 2) Built-in VITC Generator 3) At connecting box JB1 (included in the delivery)

Camcorder Service Manuals

Camcorder	Part Number	Kind of Manual
LC 125 C	72010 510 8000	Service Manual
LC 145 E	72010 510 8500 72010 508 6500	Service Manual FL-Mechanics
LC 175 HE	72010 510 5500 72010 507 9500	Service Manual U-Mechanics
LC 180 HE	72010 511 1000 72010 508 6500	Service Manual FL-Mechanics
LC 210 C	72010 511 5000	Service Manual
LC 215 C	72010 511 5500	Service Manual
LC 225 C	72010 512 2500	Service Manual
LC 230 E	72010 510 4500 72010 511 1500 72010 507 9500	Service Manual Supplement U-Mechanics
LC 232 E	72010 511 9000 72010 512 1600	Service Manual A-Mechanics
LC 235 E	72010 513 2500 72010 513 2600 72010 512 1600	Service Manual Supplement 1 A-Mechanics
LC 240 E	72010 512 1500 72010 512 1600	Service Manual A-Mechanics
LC 255 SC	72010 511 6000	Service Manual
LC 280 HE	72010 512 2000 72010 508 6500	Service Manual FL-Mechanics
LC 285 HE	72010 512 6000 72010 508 6500	Service Manual FL-Mechanics
LC 290 N	72010 512 3500	Service Manual
LC 295 SN	72010 512 7000	Service Manual
LC 310 C	72010 513 2000	Service Manual
LC 320 C	72010 514 5500	Service Manual
LC 330 E	72010 511 9000 72010 514 3000 72010 512 1600	Service Manual Supplement A-Mechanics
LC 335 E	72010 513 2500 72010 514 7000 72010 512 1600	Service Manual Supplement A-Mechanics
LC 345 E	72010 513 1000 72010 512 1600	Service Manual A-Mechanics
LC 355 SC	72010 514 7500	Service Manual
LC 360 SC	72010 513 1500	Service Manual
LC 375 HE	72010 513 0500 72010 512 1600	Service Manual A-Mechanics
LC 380 HE	72010 512 2000 72010 513 0000 72010 512 1600	Service Manual Supplement A-Mechanics
LC 400 C	72010 515 9000	Service Manual
LC 410 C	72010 515 9000	Service Manual
LC 435 E	72010 516 4500 72010 512 1600	Service Manual A-Mechanics
LC 445 E	72010 516 5500 72010 512 1600	Service Manual A-Mechanics
LC 450 SC	72010 516 9500	Service Manual
LC 460 SC	72010 517 0000	Service Manual
LC 475 HE	72010 516 5500 72010 512 1600	Service Manual A-Mechanics
LC 485 HE	72010 515 9500 72010 512 1600	Service Manual A-Mechanics
LC 500 C	72010 518 7500 72010 519 6000	Service Manual DL-Mechanics
LC 535 E	72010 518 7000 72010 512 1600	Service Manual A-Mechanics
LC 550 SC	72010 519 7000 72010 519 6000	Service Manual DL-Mechanics

Observe also the Instructions given in the Safety Service Manual Part No. 72010 800 0000!

Camcorder	Part Number	Kind of Manual
LC 560 SC	72010 519 6500	Service Manual
	72010 519 6000	DL-Mechanics
LC 575 HE	72010 518 6500	Service Manual
	72010 512 1600	A-Mechanics
LC 600 C	72010 524 2500	Service Manual
	72010 519 6000	DL-Mechanics
LC 610 C	72010 524 4500	Service Manual
	72010 519 6000	DL-Mechanics
LC 635 E	72010 524 3000	Service Manual
	72010 525 0500	B-Mechanics
LC 645 E	72010 524 3500	Service Manual
	72010 525 0500	B-Mechanics
LC 650 SC	72010 525 4500	Service Manual
	72010 519 6000	DL-Mechanics
LC 675 HE	72010 525 5000	Service Manual
	72010 525 0500	B-Mechanics
LC 685 HE	72010 525 5500	Service Manual
	72010 525 0500	B-Mechanics
LC 695 SN	72010 524 4000	Service Manual
LC 700 C	72010 529 5000	Service Manual
	72010 519 6000	DL-Mechanics
LC 735 E	72010 529 4500	Service Manual
	72010 525 0500	B-Mechanics
LC 750 SC	72010 530 9000	Service Manual
	72010 519 6000	DL-Mechanics
LC 760 SC	72010 530 9000	Service Manual
	72010 519 6000	DL-Mechanics
LC 775 HE	72010 529 4000	Service Manual
	72010 525 0500	B-Mechanics
LC 785 HE	72010 525 0500	Service Manual
	72010 529 3500	Supplement
	72010 525 0500	B-Mechanics
LC 800 C	72010 532 1500	Service Manual
	72010 519 6000	DL-Mechanics
LC 835 E	72010 532 1000	Service Manual
	72010 525 0500	B-Mechanics
LC 875 HE	72010 532 1000	Service Manual
	72010 525 0500	B-Mechanics
LC 885 HE	72010 532 0000	Service Manual
	72010 525 0500	B-Mechanics
LC 900 C	72010 530 8000	Service Manual
	72010 519 6000	DL-Mechanics
LC 935 E	72010 535 0000	Service Manual
	72010 525 0500	B-Mechanics
LC 975 HE	72010 535 0500	Service Manual
	72010 525 0500	B-Mechanics
LC 1000 VC	72010 538 4000	Service Manual
	72010 538 2700	CZ-Mechanics
LC 1150 VC	72010 540 8100	Service Manual
	72010 538 2700	CZ-Mechanics
LC 3000 E	72010 538 3000	Service Manual
	72010 525 0500	B-Mechanics
LC 3100 HE	72010 540 7000	Service Manual
	72010 525 0500	B-Mechanics
LC 5000 HE	72010 538 3000	Service Manual
	72010 525 0500	B-Mechanics
LC-D 80 E	72010 517 1500	Service Manual
	72010 512 1600	A-Mechanics
LC-D 100 E	72010 518 6000	Service Manual
	72010 512 1600	A-Mechanics

Observe also the Instructions given in the Safety Service Manual Part No. 72010 800 0000!

Camcorder	Part Number	Kind of Manual
LC-D 200 HE	72010 531 9000	Service Manual
	72010 525 0500	B-Mechanics
LC-D 300 HE	72010 535 1000	Service Manual
	72010 525 0500	B-Mechanics
LCD 6000 HE	72010 538 3000	Service Manual
	72010 525 0500	B-Mechanics
LCD 6100 HE	72010 540 7000	Service Manual
	72010 525 0500	B-Mechanics
DLC 1	1)	–
DLC 10	1)	–
DLC 20	1)	–
DLC 1000	1)	–
DLC 1500	1)	–
DLC 2000	1)	–

1) Central repair

Service Manuals – Camcorder Accessories

Accessories	Part Number	Kind of Manual
LCS 8-4	72010 514 4500	Service Manual
NA 8	72010 507 6500	Service Manual
NA 8-1	72010 507 6600	Service Manual
NA 8-2	72010 510 2500	Service Manual
NA 8-3	72010 512 6500	Service Manual
NA 8-4	72010 512 9500	Service Manual
NA 75	72010 509 3000	Service Manual
NA 75A	72010 510 1000	Service Manual
NA 75B	72010 511 5500	Service Manual
NA 85	72010 514 0000	Service Manual
NA 90	72010 514 6000	Service Manual
NA 95	72010 516 2500	Service Manual
NA 96	72010 517 5000	Service Manual
NA 96C	72010 519 5500	Service Manual
NA 96D	72010 517 5100	Service Manual
NA 97	72010 531 6500	Service Manual
NA 99	72010 534 8100	Service Manual
NA 190A	72010 512 5500	Service Manual
NA 190A	72010 524 9000	Service Manual
NA-L1	72010 517 5500	Service Manual

Service Manuals – Camera

Accessories	Part Number	Kind of Manual
DMC 5100	1)	–
DMC 5200	1)	–

1) Central repair

Observe also the Instructions given in the Safety Service Manual Part No. 72010 800 0000!

Contents: Satellite Reception

Module Chart	5.2
Retrofitting Options for Grundig Head Stations.....	5.4
Cassettes for Extension of the STC 1880 Head Station	5.4
Cassettes Overview for Head Stations	5.5
Operating Parts of Head Stations (Overview)	5.10
Cassettes Overview for Head Stations - Professional Channel Processing	5.11
Tele-Pilot® Remote Control Handsets / Overview	5.12
Service Manuals/ Unlock parental control	5.13

To be better readable part numbers are shown with two spaces.

For ordering spare parts please indicate part numbers as **twelve-figure number** without spaces.

Modul Chart

Designation	Part No.																							
		HCM 814	HCM 893	HRM 810	HRM 811	HRM 851	HRM 852	HRM 854	HRM 858 (a)	HRM 861	HRM 864	HRM 883	SINIO DTR6110S	SINIO DTR6111S CI	STR 100	STR 100 DX	STR 110	STR 1300	STR 2300	STR 2300 MV	STR 400 AP	STR 511	STR 512	
Tuner (Terr.)	29504 101 2300	●			●																			
Tuner	29504 101 6300																							
Tuner	29504 201 2400		2)																					
Tuner	29504 201 6100					●	●	●	●	●	●													
Tuner	29504 201 6200																				●			
Tuner	29504 201 7300																					●		
Tuner	29504 201 7400																						●	
Tuner	29504 201 7700															●								
Tuner	29504 201 8700															●	●							
Tuner	29504 201 8800																							
Tuner	29504 201 9200																							
Tuner	29504 451 0400														●	●								
Tuner	75990 900 3000																							
Tuner	75990 900 3100																							
Tuner	75990 900 4200																							
Tuner	75954 705 3000																							
Tuner	75954 705 3100																							
Tuner	75954 705 6600																		●	●				
Tuner	75954 705 8100																							
Tuner	75954 705 9900																							
Tuner	75955 023 7200																							
Tuner	81406 016 2500																		●					
Tuner	81406 016 2800																							
Tuner	81406 016 3500																							
Modulator	29502 017 0500			●																				
Modulator	29502 017 0600					●																		
Modulator	29502 017 1200				●																			
Modulator	29502 017 1300			●																				
Modulator	29502 017 5100								1)															
Modulator	29502 017 5200								1)															
Modulator	29502 017 5300							●																
Modulator	29502 017 5500									●														
Modulator	29502 017 5800									●														
Modulator	29502 017 6000																						2)	
Modulator	29502 017 6200	●																						
Modulator	29502 017 6500		2)																					
Modulator	29502 025 4500																							
Modulator	75954 705 9800																							
Modulator	75955 023 7300																							
Modulator	75990 900 3100																							
Modulator	75990 900 4300																							
Modulator	81406 017 2500																							
Modulator	81406 017 7500																							
PLL-Modulator	29502 025 3100																				●	●	●	
PLL-Modulator UHF	29502 025 3600																							
PLL-Modulator VHF	29502 025 3700																							
PLL-Modulator/UHF/VHF	29502 025 3800																							

1) HRM 858: 017 5100, HRM 858a: 017 5200
 2) 2 for each cassette

3) VHF or UHF dependent on the type of the modulator fitted
 4) mechanically different versions

Designation	Part No.	STR 600	STR 611	STR 6000	STR 6100	STR 6122	STR 622	STR 631	STR 632	STR 641	STR 642	STR 7100	STR 7122 TWIN	STR 8150	VCR SAT1
Tuner (Terr.)	29504 101 2300														
Tuner	29504 101 6300														
Tuner	29504 201 2400														
Tuner	29504 201 6100														
Tuner	29504 201 6200														
Tuner	29504 201 7300														
Tuner	29504 201 7400														
Tuner	29504 201 7700														
Tuner	29504 201 8700														
Tuner	29504 201 8800	●	●				●								
Tuner	29504 201 9200														
Tuner	29504 451 0400														
Tuner	75990 900 3000							●							
Tuner	75990 900 3100														
Tuner	75990 900 4200								●						
Tuner	75954 705 3000														
Tuner	75954 705 3100														
Tuner	75954 705 6600														
Tuner	75954 705 8100														
Tuner	75954 705 9900														
Tuner	75955 023 7200														
Tuner	81406 016 2500														
Tuner	81406 016 2800														
Tuner	81406 016 3500														
Modulator	29502 017 0500														
Modulator	29502 017 0600														
Modulator	29502 017 1200														
Modulator	29502 017 1300														
Modulator	29502 017 5100														
Modulator	29502 017 5200														
Modulator	29502 017 5300														
Modulator	29502 017 5500														
Modulator	29502 017 5800														
Modulator	29502 017 6000														
Modulator	29502 017 6200														
Modulator	29502 017 6500														
Modulator	29502 025 4500	●	●												
Modulator	75954 705 9800														
Modulator	75955 023 7300														
Modulator	75990 900 3100														
Modulator	75990 900 4300														
Modulator	81406 017 2500														
Modulator	81406 017 7500														
PLL-Modulator	29502 025 3100														
PLL-Modulator UHF	29502 025 3600														
PLL-Modulator VHF	29502 025 3700														
PLL-Modulator/UHF/VHF	29502 025 3800														

1) HRM 858: 017 5100, HRM 858a: 017 5200
 2) 2 for each cassette

3) VHF or UHF dependent on the type of the modulator fitted
 4) mechanically different versions

SAT

Retrofitting Options for Grundig Satellite Head Stations

Adapter Cable from 15-pin Sub-Min-D to Euro-AV.

Order no.: GAW 3000

DNS Universal Decoder retrofitting set

Order no.: GAG 1300 to connect external sets (e.g. Decoder (Descrambler), Video recorder, Video camera). Suitable for coupling in and out video and audio signals.

Cassettes for Extension of the STC 1880 Head Stations (GAF 5859)

HAC 1880 - analogue unit (without modulators)

Order no.: GAF 5900 4 times SAT analogue converter, must only be fitted with analogous VHF and/or UHF modulators

HAM 1833 - analogue VHF modulator

Order no.: GAF 6000 output channels adjustable from S3 to S24 inclusively C5 to C12

HAM 1835 - analoger UHF modulator

Order no.: GAF 6100 output channels adjustable from C21 to C69

HDC 1880 - digital unit (without modulators)

Order no.: GAF 6200 4 times SAT digital converter, must only be fitted with digital VHF and/or UHF modulators

HDM 1814 - digital VHF modulator

Order no.: GAF 6300 output channels adjustable from S21 to S41

HDM 1815 - digital UHF modulator

Order no.: GAF 6400 output channels adjustable from C21 to C69

DNS Universal Decoder retrofitting set

Order no.: GAG 1300 to connect external sets (e.g. Decoder (Descrambler), Video recorder, Video camera). Suitable for coupling in and out video and audio signals.

HTM 300 - Amplifier module for terrestrial TV programmes

Order no.: GAG 1200 to convert terrestrial TV programmes (selektive) and terrestrial UKW radio programmes (wide band).

HTM Installation Set - for the terrestrial amplifier module

Order no.: GAG 1400

Type of Cassette	Input Range	Output Range	Channel pattern, Standard	mechanical not com- patible to STC316/332	STC800, CT800 STC850, STC2400	STC 880, STC 80 CT 880	BE-120	BE-332 / BE-PLUS	BE-REMOTE	STC 1880	Order No.
SAT-TV Cassettes											
HRM 1231 (TWIN)	950 - 2150 MHz	C2-C4 S3-S24 C5-C12	CCIR			*)		17	17		GAE8300
HRM 1233 (TWIN)	950 - 2150 MHz	S3-S24 C5-C12	CCIR			*)		17	17		GAE9700
HRM 1234 (TWIN)	950 - 2150 MHz	S21-S41	CCIR			*)		17	17		GAE8400
HRM 1235 (TWIN)	950 - 2150 MHz	C21-C69	CCIR			*)		17	17		GAE9800
HRM 331 (TWIN)	950 - 2150 MHz	C2-C4 S3-S24 C5-C12	CCIR			27	03	10	17	4	GAE8300
HRM 333 A (TWIN)	950 - 2150 MHz	S3-S24 C5-C12	CCIR			27	03	10	17	4	GAE9700
HRM 334 (TWIN)	950 - 2150 MHz	S21-S41	CCIR			27	03	10	17	4	GAE8400
HRM 335 A (TWIN)	950 - 2150 MHz	C21-C69	CCIR			27	03	10	17	4	GAE9800
HRM 341 (TWIN)	950 - 2150 MHz	R1-R5 D1-D5 s2-s21 R6-R12	OIRT			27	04	11	17	4	GAF0100
HRM 343 (TWIN)	950 - 2150 MHz	s2-s21 R6-R12	OIRT			27	04	11	17	4	GAF0200
HRM 345 (TWIN)	950 - 2150 MHz	C21-C69	OIRT			27	04	11	17	4	GAF0300
HRM 800	950 - 1750 MHz	C5-C12 S8-S20	CCIR	x	01	01	01	10	17		GAV70
HRM 801	950 - 1750 MHz	C2-C4	CCIR	x	01	01	01	10	17		GAV9200
HRM 802	950 - 1750 MHz	C21-C40	CCIR	x	01	01	01	10	17		GAV9300
HRM 851	950 - 2050 MHz	C2-C4	CCIR	x	19	19	01	10	17		GAX9600
HRM 852	950 - 2050 MHz	C21-C40	CCIR	x	19	19	01	10	17		GAX9700
HRM 853	950 - 2050 MHz	C21-C40	Secam L	x	19	19	01	10	17		GAX8800
HRM 854	950 - 2050 MHz	S21-S41	CCIR	x	21	21	01	10	17		GAY4100
HRM 855	950 - 2050 MHz	R6-R12 s4-s17 D6-D12 Z6-Z16	OIRT China	x	19	19	01	10	17		GAX9800
HRM 857	950 - 2050 MHz	C21-C40 D13-D27	OIRT China	x	01	01	01	10	17		GAY0100

the most relevant cassettes are marked grey

*) only STC 880 together with operating part BE-Remote and adapter board

Type of Cassette	Input Range	Output Range	Channel pattern, Standard	mechanical not com- patible to STC316/332	STC800, CT800 STC850, STC2400	STC 880, STC 80 CT 880	BE-120	BE-332 / BE-PLUS	BE-REMOTE	STC 1880	Order No.
HRM 858	950 - 2050 MHz	C5-C12 S8-S20	CCIR	x	19	19	01	10	17		GAX7300
HRM 858A	950 - 2050 MHz	C5-C12 S4-S20	CCIR	x	21	21	01	10	17		GAY4200
HRM 859	950 - 2050 MHz	R1 - R5 D1 - D5	OIRT China	x	19	19	01	10	17		GAY0200
HRM 863	950 - 2050 MHz	C41 - C57	Secam L	x	19	19	01	10	17		GAY9900
HRM 861	950 - 2050 MHz	C2-C4	CCIR	x	19	19	01	10	17		GAZ2300
HRM 864	950 - 2050 MHz	C21-C40	CCIR	x	19	19	01	10	17		GAZ2200
HRM 866	950 - 2050 MHz	C41-C57	CCIR	x	19	19	01	10	17		GAD9700
HRM 883 (TWIN)	950 - 2050 MHz	C5-C12 S3-S30	CCIR	x		22	01	10	17		GAY8000
HRM 883-2 (TWIN)	950 - 2150 MHz Twin mit 2*Decoder	C5-C12 S3-S30	CCIR	x		22	01	10	17		GAC3000
HRM 885 (TWIN)	950 - 2050 MHz	R6-R12 s2-s27 Z2-Z26 D6-D12	OIRT China	x		22	01	10	17		GAC6700
Terrestrische Kassetten											
HTM 300	9xUHF, 2xVHF, 1xUKW (universal)	selektiv				25	01	10	17	4	GAG1200
HRM 391 (TWIN)	C2-C69 S2 - S41	C2-C4 S3-S24 C5-C12	CCIR			29	06	10	17	4	GAF2400
HRM 393 (TWIN)	C2-C69 S2 - S41	S3-S24 C5-C12	CCIR			27	04	10	17	4	GAF2500
HRM 394 (TWIN)	C2-C69 S2 - S41	S21- S41	CCIR			28	05	10	17	4	GAF2100
HRM 395 (TWIN)	C2-C69 S2 - S41	C21-C69	CCIR			27	04	10	17	4	GAE8500
HRM 381 (TWIN)	C21-C69 R1 - R12 S2 - S21 D1 - D57	R1-R5 D1-D5 s2-s21 R6-R12	OIRT			29	06	11	17	4	GAF2600
HRM 383 (TWIN)	C21-C69 R1 - R12 S2 - S21 D1 - D57	s2-s21 R6-R12	OIRT			27	04	11	17	4	GAF2700

the most relevant cassettes are marked grey

*) only STC 880 together with operating part BE-Remote and adapter board

Type of Cassette	Input Range	Output Range	Channel pattern, Standard	mechanical not com- patible to STC316/332	STC800, CT800 STC850, STC2400	min. software index of operating part					STC 1880	Order No.
						STC 880, STC 80 CT 880	BE-120	BE-332 / BE-PLUS	BE-REMOTE	STC 1880		
HRM 385 (TWIN)	C21-C69 R1 - R12 S2 - S21 D1 - D57	C2-C69 D13-D57	OIRT			27	04	11	17	4	GAF2000	
HRM 810	C2 - C12 C21 - C69	C5-C12 S8-S20	CCIR	x	01	01	01	10	17		GAV9500	
HRM 811	C2 - C12 C21 - C69	C2-C4	CCIR	x	01	01	01	10	17		GAW1700	
HRM 815	R1 - R12 C21 - C69 Z1-Z16 D1 - D57	R6-R12 s4-s17 Z6-Z16 D6-D12	OIRT China	x	08	08	01	10	17		GAX1800	
HCM 814	C2 - C12 C21 - C69	C21-C40	CCIR	x	01	01	01	10	17		GAC1200	
HCM 893 (TWIN)	48,25-855,25 MHz C2 - C69 S2 - S41	C5-C12 S3-S30	CCIR	x		22	01	10	17		GAD0800	
HCM 895 (TWIN)	R1 - R12 C21 - C69 s 1 - s38 Z1-Z38 D1 - D57	R6-R12 s2-s21 D6-D12 Z2-Z26	OIRT China	x		22	01	10	17		GAD0700	
UKW Kassetten												
HRM 325 FM	87,5-108 MHz	87,5-108 MHz	UKW			27	01	10	17		GAE6300	
HRM 326/4FM	87,5-108 MHz	Selektive	UKW			27	01	10	17		GAE6400	
HRM 324/2 ADR-FM	950 - 2150 MHz	87,5-108 MHz	UKW			27	01	14	17		GAF4700	
HRM 322 ADR-FM	950 - 2150 MHz, NF	87,5-108 MHz	UKW			27	01	10	17		GAG7700	
HRM 824/2 ADR-FM	950 - 2150 MHz	87,5-108 MHz	UKW	x	25	25	01	10	17		GAE1600	
HRM 825	87,5 - 108 MHz	87,5-108 MHz	UKW	x	01	01	01	10	17	4	GAW8800	
HCM 826/4	87,5 - 108 MHz	87,5-108 MHz	UKW	x	24	24	01	10	17		GAC9000	
AV-Umsetzer-Kassetten												
HRC 310 AV	3 x Video + Audio	je nach Modulator						16	17		GAG4800	

the most relevant cassettes are marked grey

*) only STC 880 together with operating part BE-Remote and adapter board

Type of Cassette	Input Range	Output Range	Channel pattern, Standard	mechanical not com- patible to STC316/332	STC800, CT800 STC850, STC2400	STC 880, STC 80 CT 880	BE-120	BE-332 / BE-PLUS	BE-REMOTE	STC 1880	Order No.
HRM 831 AV	Video + Audio	C2-C4	CCIR	x	05	05	01	10	17		GAZ9600
HRM 834 AV	Video + Audio	C21-C40	CCIR	x	01	01	01	10	17		GAC1100
HRM 836 AV	Video + Audio	S21-S41	CCIR	x	21	21	01	10	17		GAD9200
Digitale-Umsetzer-Kassetten											
HDM 100 P	950 - 2150 MHz	PAL C5-C12 S3-S30	CCIR	x	25	25	01	10	17		GAD3600
HDM 100 C	950 - 2150 MHz	QAM S21 - S41	QAM	x	25	25	01	10	17		GAD3700
HDM 303 P	950 - 2150 MHz	PAL S3-S30 C5-C12	CCIR			25	01	10	17		GAE6500
HDM 303 PA	950 - 2150 MHz	PAL S3-S24 C5-C12	CCIR			27	04	10	17		GAF8200
HDM 305 P	950 - 2150 MHz	PAL C21-C69	CCIR			27	03	10	17		GAE8600
HDM 353 P	950 - 2150 MHz	PAL s2-s21 R6-R12	OIRT			27	03	10	17		GAE6600
HDM 355 P	950 - 2150 MHz	PAL C21-C69 D13-D57	OIRT			27	03	10	17		GAE9900
HDM 363 P-CI	950 - 2150 MHz	PAL S3-S24 C5-C12	CCIR			25	01	10	17	4	GAG3300
HDM 365 P-CI	950 - 2150 MHz	PAL C21-C69	CCIR			25	01	10	17	4	GAG3400
HDM 314 C	950 - 2150 MHz	QAM S21-S41	QAM			25	01	10	17	4	GAE6700
HDM 315 C	950 - 2150 MHz	QAM C21-C69	QAM			25	04	10	17	4	GAF7400

the most relevant cassettes are marked grey

*) only STC 880 together with operating part BE-Remote and adapter board

Type of Cassette	Input Range	Output Range	Channel pattern, Standard	mechanical not com- patible to STC316/332	STC800, CT800 STC850, STC2400	STC 880, STC 80 CT 880	BE-120	min. software index of operating part			Order No.
								BE-332 / BE-PLUS	BE-REMOTE	STC 1880	
HDM 374 C (TWIN)	950 - 2150 MHz	QAM S21-S41	QAM					11	17	4	GAF7200
HDM 375 C (TWIN)	950 - 2150 MHz	QAM C21-C69	QAM					12	17	4	GAF7300
HDM 384 (TWIN)	950 - 2150 MHz	S21 - S41	QAM					21	21		GAH6300
HDM 385 (TWIN)	950 - 2150 MHz	C21 - C69	QAM					21	21		GAH6400
HDMT 163 P CI	950 - 2150 MHz	S3 - S24 C5 - C12	CCIR			25	01	10	17	4	GAH6000
HDMT 164 P CI	950 - 2150 MHz	S21 - S41	CCIR			25	01	10	17	4	GAH6600
HDMT 165 P CI	950 - 2150 MHz	C21 - C69	CCIR			25	01	10	17	4	GAH6700

Please download the required Software Updates via the GRUNDIG Homepage <http://partnerweb.grundig.de> from Part **Kundendienst**.

 the most relevant cassettes are marked grey

*) only STC 880 together with operating part BE-Remote and adapter board

Operating Parts of Head Stations (Overview)

SAT

Operating Part	Head Station	LED	Sockets Front	Controller	Software Update	EEPROM
BE 8xx	Series 800 Series 880	-	SERVICE 4-polig	Motorola MC68HC705B32B 32K - OTP	Change of controller	Internal
BE 120	STC 1200	red	SERVICE 4-polig	Motorola MC68HC705B32B 32K - OTP	Change of controller	Internal
BE 332	STC 332	green	SERVICE 4-polig	Siemens C163 128K - Flash	PC + PMS 1*	External
BE-PLUS	STC 1200 STC 332 STC 316	green	SERVICE 4-polig + RS 232 9-polig	Siemens C163 128K - Flash	PC (RS 232)	External with cocket
BE-REMOTE	STC 1200 STC 332 STC 316	yellow	RS 232 9-polig	Mitsubishi M306N0FGTFP 256K - Flash	PC (RS 232)	External with cocket

*PMS1 = Programmier Manager SAT 1 (sold out)

the most relevant operating parts are marked grey

Cassettes Overview for Head Stations - Professional Channel Processing

Type of Cassette	Input Range	Output Range	Channel pattern, Standard	BE-Professional**	Order No.
Analogue Sat TV Cassettes					
PSAP 1000 (TWIN)	950-2150MHz	*(A)C2-C4 *(B)S3-S24 C5-C12	CCIR	19	GAH2700
PSAP 3000 (TWIN)	950-2150MHz	S3-S24 C5-C12	CCIR	19	GAH2800
PSAP 4000 (TWIN)	950-2150MHz	S21-S41	CCIR	19	GAH3000
PSAP 5000 (TWIN)	950-2150MHz	C21-C69	CCIR	19	GAH2900
Terrestrial Cassettes					
PTAP 1000 (TWIN)	C2-C69 S-2-S41	*(A)C2-C4 *(B)S3-S24 C5-C12	CCIR	19	GAH3500
PTAP 3000 (TWIN)	C2-C69 S-2-S41	S3-S24 C5-C12	CCIR	19	GAH3600
PTAP 4000 (TWIN)	C2-C69 S-2-S41	S21-S41	CCIR	19	GAH3800
PTAP 5000 (TWIN)	C2-C69 S-2-S41	C21-C69	CCIR	19	GAH3700
UKW Cassettes					
PTAF 2000	87,5-108 MHz	87,5-108 MHz	UKW	19	GAH3200
PTFF 2000	87,5-108 MHz	Selektive	UKW	19	GAH3300
PSRF 2000	950-2150MHz	87,5-108 MHz	UKW	19	GAH3400
Digitale Converter Cassettes					
PSDP 3000	950-2150 MHz	PAL S3-S24 C5-C12	CCIR	19	GAH3900
PSDP 5000	950-2150 MHz	PAL C21-C69	CCIR	19	GAH4000
PSDN 4000	950-2150 MHz	QAM S21-S41	QAM	19	GAH4100
PSDQ 4000	950-2150 MHz	QAM S21-S41	QAM	21	GAH4200
PSDQ 5000	950-2150 MHz	QAM C21-C69	QAM	21	GAH4300

* Converter A or B at TWIN Cassettes

** Minimum Software index of operating part

GRUNDIG Tele-Pilot® Remote Control Handsets / Overview

Satellite product range



rc sat
29622 046 1700



SRC5
75990 900 0800



TP 715 SAT
75990 900 5800



TP 716 SAT
23800 001 0100



TP 720 SAT
29642 059 1800



TP 760 SAT
23800 006 0100
23800 006 0200

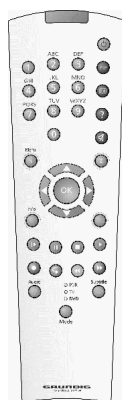

TP 777
72011 713 1600



TP 778 DR
23800 005 0200



TP 805 SAT
75990 900 0600



TP 820 SAT
29642 061 0300



SAT Control 1
72011 620 0000

SAT

Service Manuals / Unlock Parential Control

Set	Part No.	Kind of Manual	Unlock parental control
BE-PLUS	72010 030 6000	Service Manual	
BE-REMOTE	72010 030 6000 72010 030 6100	Service Manual Supplement 1	
DTR 1100	Exchange Set		
DTR 1200	Exchange Set		
DTR 2000 S	Exchange Set		
DTR 6000 S	Exchange Set		0325
DTR 6001 S CI	Exchange Set		0325
SELEXX PDR 5000 S DIG	Central Repair		
SELIO PDR 5200 S CI	Central Repair		
SINIO DTR 6110 S	72010 043 4000	Service Manual.	1515
SINIO DTR 6111 S CI	72010 043 4000	Service Manual	1515
SNR 105 microSAT	72010 020 9000 72010 020 9100	Service Manual Supplement 1	
STC 1200	72010 023 3000	Service Manual.	
STC 1650	72010 018 0000	Service Manual	
STC 1880	72010 030 2000	Service Manual	
STC 316	72010 041 2000	Service Manual	
STC 332	72010 023 7000	Service Manual	
STC 50	72010 030 3000	Service Manual	
STC 80	72010 018 6000 72010 018 6100	Service Manual Supplement 1	
STE 1000	Exchange Set		
STE 1000	72010 019 0000	Service Manual	clear code; 1515
STR 100 DX	72010 021 0000	Service Manual	
STR 100 FR MicroSAT	72010 019 2000	Service Manual	
STR 100 MicroSAT	72010 018 2000	Service Manual	
STR 1300	72010 029 6000	Service Manual	◀ ▶ ▼ ▲
STR 1300 FR	72010 029 9000	Service Manual	◀ ▶ ▼ ▲
STR 2300	72010 025 1000 72010 025 1100	Service Manual Supplement 1	
STR 2300 FR	72010 027 4000	Service Manual	
STR 2300 MV	72010 025 1000 72010 025 1100	Service Manual Supplement 1	
STR 511 FR	72010 018 1000	Service Manual	
STR 512	72010 016 7000	Service Manual	
STR 512 FR	72010 018 1000	Service Manual	
STR 535 N MAC	72010 018 0000	Service Manual	
STR 600 AP	72010 021 2000	Service Manual	
STR 600 AP	72010 021 2000	Service Manual	
STR 600 AP / F / E / P	72010 021 2000 72010 021 2100	Service Manual Supplement 1	◀ ▶ ▼ ▲
STR 6000	72010 029 7000	Service Manual	
STR 6000 FR	72010 030 4000	Service Manual	
STR 6100	72010 029 8000	Service Manual	▶ ◀ ▼ ▲

Observe also the instructions given in the "Safety" Service Manual Part No. 72010 800 0000!

Set	Part No.	Kind of Manual	Unlock parental control
STR 6100 FR	72010 030 1000	Service Manual	▶ ◀ ▼ ▲
STR 611	72010 021 3000 72010 021 3100	Service Manual Supplement 1	▶ ◀ ▼ ▲
STR 6122 TWIN	72010 023 4000	Service Manual	▶ ◀ ▼ ▲
STR 622 TWIN	72010 021 3000	Service Manual	▶ ◀ ▼ ▲
STR 631	72010 020 3000	Service Manual	clear code; 1515
STR 631	72010 020 3000	Service Manual	clear code; 1515
STR 631 FR	72010 020 4000	Service Manual	clear code; 1515
STR 632	72010 020 3000	Service Manual	clear code; 1515
STR 632	72010 020 3000	Service Manual	clear code; 1515
STR 632 FR	72010 020 4000	Service Manual	clear code; 1515
STR 641 + FR	72010 020 3000 72010 020 3100	Service Manual Supplement 1	clear code; 1515
STR 642 + FR	72010 020 3000 72010 020 3100	Service Manual Supplement 1	clear code; 1515
STR 7100	72010 023 9000 72010 023 9100	Service Manual Supplement 1	▶ ◀ ▼ ▲; clear lock (menu)
STR 7100 FR	72010 027 5000	Service Manual	▶ ◀ ▼ ▲
STR 7122 TWIN	72010 025 2000 72010 025 2100	Service Manual Supplement 1	▶ ◀ ▼ ▲
STR 8150	72010 042 0000	Service Manual	clear code; 1515
VCR SAT1	72010 537 5500	Service Manual	

Observe also the instructions given in the "Safety" Service Manual Part No. 72010 800 0000!

Contents: Audio

GRUNDIG Tele-Pilot® Remote Control Handsets / Overview6.2
 Service Manuals Audio/HiFi sorted by Sets6.4
 Service Manuals CarAudio sorted by Sets6.6
 Anti-theft Systems for Grundig Car Radios6.7
 Anti-theft Coding of Car Radios6.8

To be better readable part numbers are shown with two spaces.
 For ordering spare parts please indicate part numbers as **twelve-figure number** without spaces.

GRUNDIG Tele-Pilot® Remote Control Handsets / Overview Audio / HiFi Product Range



RC PA 5
59802 630 0100



RC M 49
75955 006 3000



M14
75955 004 0100



M19/29
75955 002 9100



RR 660 CD
75955 005 0100



RR 760 CD
75955 005 5000



Personal Remote 20
72011 713 0200

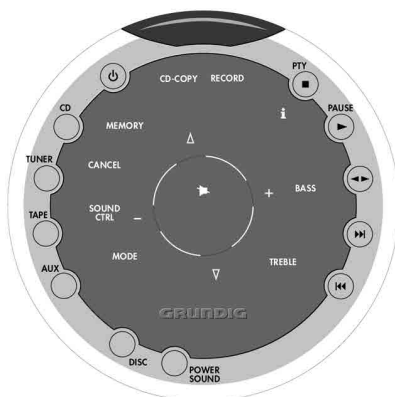

RC PA 6
59802 620 5000



RC RR 770 CD
75955 026 7000



M100
59802 624 0100
59802 624 5100

Audio/HiFi



RC CDM 800
75955 036 3800
RC CDM 900
75955 038 3000



RC UMS 100
75955 032 0100



UMS 200
75955 032 5000



MASQ RRCD 9100 PLL
75955 049 9000



MS 4101
75955 044 9800



UMS 4101
75955 051 0100



UMS 4100
75955 050 0100



UMS 4200
75955 057 0100



UMS 5100
75955 032 0300



UMS 5101 CDC
75955 048 0100



RRCD 4204 PLL
75955 064 0100

Audio/HiFi

Audio/HiFi Service Manuals sorted by sets

Set	Service Manual
APOLLO 2000	72010 760 7500
BEEZZ RRCD 4101	Exchange Set
Boy 47	Exchange Set
CCF 23	72010 755 6500
CD 21	72010 755 5500
CD 22	72010 755 5500
CD 23	72010 756 3500
CDM 700	72010 755 7000
CDM 800	72010 771 4500
CDM 900	72010 771 5500
CDP 180	Exchange Set
CDP 210	72010 755 1500
CDP 310	72010 757 8500
CDP 410	Exchange Set
CDP 440	Exchange Set
CDP 76	72010 755 1000
CDP-S 150	72010 752 7000
CDP-S 250	72010 757 1000
CF 21	72010 755 6000
City Boy 40	Exchange Set
City Boy 50 PR 5100	Exchange Set
City Boy 52	Exchange Set
Concert Boy 240	Exchange Set
CR 120	Exchange Set
CR 120 A	Exchange Set
Ctiv Boy 31 PR 3201	Exchange Set
FREAXX 10 RRCD 4303	Exchange Set
FREAXX 20 RRCD 4202	72010 772 3500
FREAXX 30 RRCD 4203 PLL	72010 772 4500
FREAXX 40 RRCD 4204 PLL	72010 772 5000
FREEZZ 10 RRCD 4300	Exchange Set
FREEZZ 20 RRCD 4301 PLL	Exchange Set
K-CDP 66	72010 755 0500
K-RCD 120	72010 756 5000
KM 12	72010 754 3000
KM 13	72010 757 1500
M 100 A	72010 749 7500
M 100 ADPL	72010 750 6500
M 100 CDC	72010 750 7000
M 100 CF	72010 749 8500
M 100 R	72010 749 7500
M 100 T	72010 750 6000
M 100-CD MKII	72010 754 3500
M 14	72010 759 4500
M 17-C	72010 752 2500

Set	Service Manual
M 18-C	72010 755 8500
M 19-C	72010 759 1500
M 27-C	72010 752 2500
M 28-C	72010 755 8500
M 29-C	72010 759 1500
M 37-DC	72010 753 2500
M 38-C	72010 755 8500
M 48-DC	72010 755 8500
M 49-DC	72010 759 4000
M 7-C	72010 752 2500
MASQ RRCD 9100 PLL	72010 771 9500
Mpaxx M-P 150	Exchange Set
MPaxx MP100	72010 761 0000
MPaxx MP150	72010 771 0500
MPaxx SP 4101	72010 771 9000
MPaxx SP 9100 PLL	72010 771 9000
MS 4101	72010 771 7000
Music Boy 40 RP 4200	Exchange Set
Music Boy 50 RP 5200	Exchange Set
Music Boy 50 RP 5240 LW	Exchange Set
Music Boy 51 RP 5201 PLL	Exchange Set
MYSTIXX CDP 9100 SPCD	72010 772 0500
MYSTIXX CDP 9200 SPCD	72010 772 3000
NOCTUS SC 9100 DCF RDS	72010 771 8500
Ocean Boy 350	Exchange Set
Ocean Boy 510	Exchange Set
PA 5 - TurNiT	72010 758 0500
PA 6	72010 760 7000
PLANIXX CDP 4103 AS 10	Exchange Set
PLANIXX CDP4104 AS 40 PLL	Exchange Set
Prima Boy 100	Exchange Set
Prima Boy 80	Exchange Set
R 21	72010 755 9000
R 22 DPL	72010 755 9000
R 23 DPL	72010 757 2000
RBX-1	72010 752 2000
RCD 2000	72010 760 6000
RCD 405	72010 752 3000
RR 276 / L	Exchange Set
RR 300 CD	72010 760 5000
RR 315	Exchange Set
RR 316 / L	Exchange Set
RR 420 CD	72010 752 4000
RR 430 CD	72010 760 0000
RR 440 CD	72010 771 1500

Observe also the instructions given in the "Safety" Service Manual Part No. 72010 800 0000!

Set	Service Manual
RR 440 CD	Exchange Set
RR 630 CD	72010 759 3000
RR 640 CD	72010 771 0000
RR 660 CD	72010 759 3000
RR 670 CD	72010 771 0000
RR 720 CD	72010 759 3500
RR 740 CD	72010 771 1000
RR 760 CD	72010 759 3500
RR 770 CD	72010 771 1000
SC 900	72010 754 4500
SC 910	72010 754 4000
Sonoclock 13	Exchange Set
Sonoclock 13/ L	Exchange Set
Sonoclock 186	Exchange Set
Sonoclock 186	Exchange Set
Sonoclock 22	Exchange Set
Sonoclock 30 SC 3300	Exchange Set
Sonoclock 30 SC 3300	Exchange Set
Sonoclock 30 SC 3340 LW	Exchange Set
Sonoclock 32	Exchange Set
Sonoclock 42	Exchange Set
Sonoclock 420	Exchange Set
Sonoclock 50 SC 5300	Exchange Set
Sonoclock 50 SC 5340 LW	Exchange Set
Sonoclock 51 SC 5301	Exchange Set
Sonoclock 52 SC 5302	Exchange Set
Sonoclock 55 SC 5305	Exchange Set
Sonoclock 620	Exchange Set
Sonoclock 690	Exchange Set
Sonoclock 720	Exchange Set
Sonoclock 740	Exchange Set
Sonoclock 755	Exchange Set
Sonoclock 755	Exchange Set
Sonoclock 890	Exchange Set
SQUIXX CDP 4100	Exchange Set
SQUIXX CDP 4101 AS 10	Exchange Set
SQUIXX CDP 4102 AS 40	Exchange Set
SQUIXX CDP 4200 AS 45	Exchange Set
ST 16 (ADR)	72010 752 1000
T 22	72010 755 4000
TurNiT - PA5	72010 758 0500
UMS 100	72010 771 6000
UMS 11	72010 757 2500

Set	Service Manual
UMS 12	72010 757 2500
UMS 12-S	72010 757 2500
UMS 15	72010 760 8500
UMS 200	72010 771 7500
UMS 25	72010 760 9500
UMS 4100	72010 771 8000
UMS 4101	72010 771 8000
V 14 DPL-RF	72010 752 1500
V 21	72010 755 4500
V 23	72010 755 5000
VARIXX UMS 4200	72010 772 2500
VERTIGA UMS 5100	72010 772 0000
VERTIGA UMS 5101 CDC	72010 772 2000
Yacht Boy 208	Exchange Set
Yacht Boy 218	Exchange Set
Yacht Boy-P2000	72010 757 0000

Car Audio Service Manuals sorted by sets

Set	Service Manual
Advance CC	72010 760 4000
Advance CD	72010 760 4500
BOOSTER PA 120	72010 731 9500
BOOSTER PA 240	72010 732 0000
EC 4000 RDS	72010 748 5000
EC 4200 RDS	72010 759 2000
EC 4290 CD	72010 750 5500
EC 4490 CD	72010 759 2500
EC 4600 RDS	72010 752 7500
EC 4700 RDS	72010 760 1500
EC 4790 CD	72010 760 2000
EC 4890 CD	72010 771 2000
EC 7400 RDS	72010 739 5000
EC 7500 RDS	72010 739 5000
MCD 20	72010 733 6000
MCD 30	72010 737 2500
MCD 36	72010 748 3000
MCD 40	72010 748 3000
MCD 46	72010 771 2500
MCD 50	72010 771 3000
SCC 3400 RDS	72010 771 4000
SCC 3460 RDS	72010 771 4000
SCC 5460 RDS	72010 772 1000
SCD 1590 VD	72010 739 1000
SCD 1910 RDS	72010 733 2000
SCD 3390 RDS	72010 757 8000
SCD 3490 RDS	72010 771 4000
SCD 3590	72010 739 1000
SCD 3590 RDS	72010 771 4200
SCD 5290 RDS	72010 749 3500
SCD 5390 RDS	72010 749 4500
SCD 5410 DAB	72010 772 4000
SCD 5490 RDS	72010 772 1000
SCD 5690 RDS	72010 749 4500
WKC 1630	72010 744 9500
WKC 1650 VD	72010 736 1000
WKC 1670 VD	72010 738 7000
WKC 1700 VD	72010 791 8500
WKC 1701 VD	72010 791 8500
WKC 1903 RDS	72010 731 0500
WKC 1904 RDS	72010 736 0500
WKC 2201 RDS	72010 758 6000
WKC 3200	72010 752 4500
WKC 3201	72010 752 4500
WKC 3300	72010 752 4500

Set	Service Manual
WKC 3301	72010 752 4500
WKC 3600	72010 749 1500
WKC 3630	72010 744 9500
WKC 3650	72010 736 1000
WKC 3700	72010 730 6000
WKC 3700 R	72010 730 6000
WKC 3701	72010 740 2000
WKC 3701 R	72010 730 6500
WKC 3904 RDS	72010 731 8000
WKC 3905 RDS	72010 731 8500
WKC 5100	72010 746 3500
WKC 5101	72010 746 3500
WKC 5200	72010 746 3500
WKC 5201	72010 746 3500
WKC 5300	72010 746 3000
WKC 5600	72010 746 3000
WKC 6400 RDS	72010 740 0000
WKC 6500 RDS	72010 740 0000

Observe also the instructions given in the "Safety" Service Manual Part No. 72010 800 0000!

Anti-theft Systems for Grundig Car Radios

Car Radio WKC/ SCD/EC..	Optional Code Number 1)	Specific Code Number 2)	Removable Control Panel	Quick-out Unit 3)
1590 VD		●		●
1630 VD		●	●	
1650 VD		●	●	
1670 VD		●	●	
1903 RDS		●	●	
1904 RDS		●	●	
1905 RDS		●	●	
1910 RDS		●	●	
2201 RDS		●	●	
2301 RDS		●	●	
3200 RDS		●	●	
3201 RDS		●	●	
3300 RDS		●	●	
3301 RDS		●	●	
3390 RDS		●	●	
3851 RDS		●	●	
3860 VD/aVD	●	●		
3904 RDS		●	●	
3905 RDS		●	●	
5100 RDS		●	●	
5101 RDS		●	●	
5200 RDS		●	●	
5201 RDS		●	●	
5290 RDS		●	●	
5300 RDS		●	●	
5390 RDS		●	●	
5500 RDS/A/C		●	●	
5600 RDS		●	●	
5690 RDS		●	●	
6400 RDS		●	●	

Car Radio WKC/ SCD/EC..	Optional Code Number 1)	Specific Code Number 2)	Removable Control Panel	Quick-out Unit 3)
6500 RDS		●	●	
7400 RDS		●	●	
7500 RDS		●	●	
Advance CC		●	●	
Advance CD		●	●	
EC 4000 RDS		●	●	
EC 4200 RDS		●	●	
EC 4290 RDS		●	●	
EC 4490 RDS		●	●	
EC 4600 RDS		●	●	
EC 4700 RDS		●	●	
EC 4790 CD		●	●	
EC 4890 CD		●	●	
SCC 3400 RDS		●	●	
SCC 3460 RDS		●	●	
SCC 5460 RDS		●	●	
SCD 3490 RDS		●	●	
SCD 3590 RDS		●	●	
SCD 5410 DAB		●	●	
SCD 5490 RDS		●	●	

- 1) It is possible to enter any code number as 4 figures.
- 2) The car radios are given a 4-place code number at the factory which cannot be changed.
- 3) Quick-out plug-in unit. RS plug-in unit, order number G.IB 0297
 You can withdraw the car radio easily from the compartment by a handle and take it along with you.

Anti-theft Coding of Car Radios

For types WKC/SCD/EC...

1630, 1650, 1670, 1703, 1704, 1705, 1903, 1910, 2670, 2680, 2803, 2804, 3851, 3870, 3880, 3904, 3905, 4804, 4870, 4871, 5000, 5500, 6400, 6500, 7400, 7500

The following is a description of the coding and decoding methods for the different car radios.

Activating the coding

Radio is playing: Depress button **A** (see table) for more than 3 seconds -> "CODE" appears in the display. After 3 seconds the display shows **B** (see table). Enter the code number: The code number is entered by repeatedly pressing the station buttons 1-4 (station button 1 for figure 1, station button 2 for figure 2 and so on); a wrong code number can be corrected by overwriting, i.e. by entering a new code number. Confirm the code number: Depress button **C** (see table) for more than 3 seconds -> "SAFE" appears in the display.

Is the coding activated?

Radio is playing: Depress button **D** (see table) for more than 3 seconds; the coding is activated when "SAFE" appears in the display. After about 3 seconds, **E** (see table) appears in the display. Switch the radio off/on - radio starts playing; the coding is not activated when "CODE" appears in the display. After about 3 seconds, the display shows **F** (see table). Switch the radio off/on - radio starts playing.

Putting into operation again

On disconnection from the supply voltage the radio is electronically locked. Reconnect the radio correctly to the supply voltage. Switch the radio on. "SAFE" appears in the display. After about 3 seconds, the display shows **G** (see table). Enter the code number. Confirm the code number: Depress button **H** (see table) for more than 3 seconds -> "SAFE" appears in the display. After about 3 seconds the radio starts playing.

The entered code number is wrong: -> "SAFE" appears in the display. The figure on the left of the code number indicates the number of attempts counted. Between the attempts 1-7 the waiting time increases to 24 hours. After the 7th attempt there is always a waiting time of 24 hours until a new code can be entered.

Types WKC/SCD/EC . .	4870, 5500, 5000, 3851, 3870, 3880, 4871, 6400, 6500	1630, 1650, 1670, 2803, 2804, 2670, 2680, 4804	1903, 3904, 3905	1910, 7400, 7500	1703, 1704, 1705
A	FM	U	U	U	FM
B	-----	1-----	1-----	-----	-----
C	FM	U	U	U	FM
D	FM	U 1)	U	U	FM
E	1-----	1 1 ---	1-----	1-----	-----
F	-----	1-----	1-----	-----	-----
G	1-----	1 1 ---	1-----	1-----	-----
H	FM	U	U	U	FM
I	FM	U	U	U	FM
K	1-----	1 1 ---	1-----	1-----	-----
L	FM	U	U	U	FM

Deactivating the coding

Radio is playing: Depress button **I** (see table) for more than 3 seconds -> "SAFE" appears in the display. After about 3 seconds the display shows **K** (see table). Enter the code number. Confirm the code number: Press button **L** (see table) for more than 3 seconds. After about 3 seconds the radio starts playing.

The entered code number is wrong: -> "SAFE" appears in the display. The figure on the left of the code number indicates the number of attempts counted. Between the attempts 1-7 the waiting time increases to 24 hours. After the 7th attempt there is always a waiting time of 24 hours until a new code can be entered.

1) The coding is activated when "SAFE" flashes in the display with the car radio switched off.

for types WKC/SCC/SCD/EC...

5100, 5101, 5200, 5201, 5290, 5300, 5390, 5410, 5460, 5490, 5600, 5690

The following is a description of the coding and decoding methods for the different car radios.

Activating the coding

Radio is playing: Depress button **EXPERT** for more than 1 second, with the rotary knob, select "CODE" in the display. Press button **EXPERT** shortly -> display shows E -- -- -- --;

Enter the code number: The code is entered by repeatedly pressing the station buttons 1-4 (station button 1 for figure 1, station button 2 for figure 2 and so on).

A wrong code number can be corrected by overwriting, i.e. entering a new code number.

Confirm the code number: Press the **EXPERT** button shortly -> display shows "SAFE"

Leave the Expert mode: Press **EXPERT** for more than 1 second.

Is the coding activated?

Radio is playing: Press the **EXPERT** button for more than 1 second.

The coding is activated when "SAFE" is indicated in the display.

The coding is not activated when "CODE" is shown in the display.

Leave the Expert mode: Press **EXPERT** for more than 1 second.

Putting into operation again

On disconnection from the supply voltage the radio is electronically locked. Reconnect the radio correctly to the supply voltage.

Switch the radio on -> the display shows "SAFE". After about 3 seconds the display shows 1-- -- -- --.

The figure on the left of the code number indicates the number of attempts counted. Between the attempts 1-7 the waiting time increases to 24 hours. After the 7th attempt there is always a waiting time of 24 hours until a new code can be entered.

Enter the code number.

Confirm the code number: Press the **EXPERT** button shortly; "SAFE" appears in the display. After about 3 seconds the radio starts playing.

The entered code number is wrong -> "SAFE" appears in the display.

Deactivating the coding

The radio is playing: Press the **EXPERT** button for more than 1 second, with the rotary knob select "SAFE" in the display.

Press the **EXPERT** button shortly -> the display shows 1-- -- -- --

Enter the code number.

Confirm the code number: Press the **EXPERT** button shortly -> "CODE" is indicated in the display.

The entered code number is wrong -> "SAFE" is shown in the display

Press **EXPERT** for more than 1 second.

for types WKC/SCD/EC...
4000, 4200, 4290, 4490, 4600, 4790, 4890

The following is a description of the coding and decoding methods for the different types of car radios.

Activating the coding

Radio is playing: Press button Φ (Expert) for more than 1 second, with the rotary knob on the right select "CODE" in the display. Press button Φ (Expert) shortly -> CH -- -- -- -- is shown in the display.

Enter the code number by turning the right shaft encoder.

Confirm the code number: Press the **right shaft encoder** shortly -> display shows "SAFE"

Leave the Expert mode: Press button Φ (Expert) for more than 1 second.

Is the coding activated?

Radio is playing: Press button Φ (Expert) for more than 1 second.

The coding is activated when "SAFE" is indicated in the display.

The coding is not activated when "CODE" is indicated in the display.

Leave the Expert mode: Press button Φ (Expert) for more than 1 second.

Putting into operation again

On disconnection of the supply voltage the radio is electronically locked.

Reconnect the radio correctly to the supply voltage.

Switch the radio on -> display shows "SAFE". After about 1 second, 1-- -- -- --. is indicated in the display.

The figure on the left of the code number indicates the number of attempts counted. Between the attempts 1-7 the waiting time increases to 24 hours. After the 7th attempt there is always a waiting time of 24 hours until a new code can be entered.

Enter the code number.

Confirm the code number: Press the **right shaft encoder** shortly; "SAFE" is indicated in the display. After about 1 second the radio starts playing.

The entered code number is not correct -> "SAFE" is indicated in the display.

Deactivating the coding

Press button Φ (Expert) for more than 1 second, with the rotary knob select "SAFE" in the display.

Press the **right shaft encoder** shortly -> CH 1-- -- -- -- is indicated in the display.

Enter the code number.

Confirm the code number: Press the **right shaft encoder** shortly; "CODE" is indicated in the display.

The entered code number is not correct -> "SAFE" is indicated in the display.

Press button Φ (Expert) for more than 1 second.

for types WKC/SCD/EC/SCC...



2201, 2301, 3200, 3201, 3300, 3301, 3390, 3400, 3460, 3490

The following is a description of the coding and decoding methods for the different types of car radios

Activating the coding

Radio is playing

Press the EXPERT button until a signal is sounded. "EXPERT" is shortly indicated in the display.

Press any of the buttons   until "CODE" is indicated in the display. Press button EXPERT shortly. The indication -- -- -- -- flashes in the display.

Enter the code number: The code is entered by repeatedly pressing the station buttons 1-4 (station button 1 for figure 1, station button 2 for figure 2 and so on).

A wrong code number can be corrected by overwriting, i.e. entering a new code number.

Confirm the code number: Press EXPERT shortly -> "SAFE" is indicated in the display.

Leave the Expert mode: Press the EXPERT button until a signal is sounded.

Is the coding activated?

Radio is playing: Press the EXPERT button for more than 1 second.

The coding is activated when "SAFE" is indicated in the display.

The coding is not activated when "CODE" is indicated in the display.

Leave the Expert mode: Press the EXPERT button for more than 1 second.

Putting into operation again

On disconnection of the supply voltage the radio is electronically locked.

Reconnect the radio correctly to the supply voltage.

Switch the radio on -> "SAFE" is indicated in the display.

After about 3 seconds 1-- -- -- -- is indicated in the display.

Enter the code number: The code is entered by repeatedly pressing the station buttons 1-4 (station button 1 for figure 1, station button 2 for figure 2 and so on).

A wrong code number can be corrected by overwriting, i.e. entering a new code number.

Confirm the code number: Press the EXPERT button until "SAFE" is indicated in the display.



Radio starts playing after about 2 seconds.

The entered code number is not correct -> "SAFE" is indicated in the display.

The figure on the left of the code number indicates the number of attempts counted. Between the attempts 1-7 the waiting time increases to 24 hours. After the 7th attempt there is always a waiting time of 24 hours until a new code can be entered.

Deactivating the coding

Radio is playing. Press the EXPERT button until a signal is sounded. "EXPERT" is shortly indicated in the display.

Press any of the buttons   until "SAFE" is indicated in the display. Press button EXPERT shortly. The indication 1-- -- -- -- flashes in the display.

Enter the code number: The code is entered by repeatedly pressing the station buttons 1-4 (station button 1 for figure 1, station button 2 for figure 2 and so on).

A wrong code number can be corrected by overwriting, i.e. entering a new code number.

Confirm the code number: Press EXPERT shortly -> "CODE" is indicated in the display.

Leave the Expert mode: Press the EXPERT button until a signal is sounded.

Calendar 2003

January	February	March	April	May	June
1 We New Year	1 Sa	1 Sa	1 Tu	1 Th 1st May	1 Su
2 Th 1	2 Su	2 Su	2 We	2 Fr	2 Mo
3 Fr	3 Mo	3 Mo	3 Th 14	3 Sa	3 Tu
4 Sa	4 Tu	4 Tu	4 Fr	4 Su	4 We 23
5 Su	5 We 6	5 We 10	5 Sa	5 Mo	5 Th
6 Mo	6 Th	6 Th	6 Su	6 Tu	6 Fr
7 Tu	7 Fr	7 Fr	7 Mo	7 We 19	7 Sa
8 We 2	8 Sa	8 Sa	8 Tu	8 Th	8 Su Whit Sunday
9 Th	9 Su	9 Su	9 We 15	9 Fr	9 Mo Whit Monday
10 Fr	10 Mo	10 Mo	10 Th	10 Sa	10 Tu
11 Sa	11 Tu	11 Tu	11 Fr	11 Su	11 We 24
12 Su	12 We 7	12 We 11	12 Sa	12 Mo	12 Th
13 Mo	13 Th	13 Th	13 Su	13 Tu	13 Fr
14 Tu	14 Fr	14 Fr	14 Mo	14 We 20	14 Sa
15 We 3	15 Sa	15 Sa	15 Tu	15 Th	15 Su
16 Th	16 Su	16 Su	16 We 16	16 Fr	16 Mo
17 Fr	17 Mo	17 Mo	17 Th	17 Sa	17 Tu
18 Sa	18 Tu	18 Tu	18 Fr Good Friday	18 Su	18 We 25
19 Su	19 We 8	19 We 12	19 Sa	19 Mo	19 Th
20 Mo	20 Th	20 Th	20 Su Easter Sunday	20 Tu	20 Fr
21 Tu	21 Fr	21 Fr	21 Mo Easter Monday	21 We 21	21 Sa
22 We 4	22 Sa	22 Sa	22 Tu	22 Th	22 Su
23 Th	23 Su	23 Su	23 We 17	23 Fr	23 Mo
24 Fr	24 Mo	24 Mo	24 Th	24 Sa	24 Tu
25 Sa	25 Tu	25 Tu	25 Fr	25 Su	25 We 26
26 Su	26 We 9	26 We 13	26 Sa	26 Mo	26 Th
27 Mo	27 Th	27 Th	27 Su	27 Tu	27 Fr
28 Tu	28 Fr	28 Fr	28 Mo	28 We 22	28 Sa
29 We 5		29 Sa	29 Tu	29 Th Ascension of Christ	29 Su
30 Th		30 Su	30 We 18	30 Fr	30 Mo
31 Fr		31 Mo		31 Sa	

Messetermine

Auto Rai
Genfer Autosalon
CeBIT

07.02.-26.02.2003, Amsterdam
06.03.-16.03.2003, Genf
12.03.-19.03.2003, Hannover

Car & Sound
Anga Cable
eltec

11.04.-13.04.2003, Sinsheim
03.06.-06.06.2003, Köln
25.06.-27.06.2003, Nürnberg

Fair Dates
E. & O.E.

Kalender 2003

July	August	September	October	November	December
1 Tu	1 Fr	1 Mo	1 We 40	1 Sa	1 Mo
2 We 27	2 Sa	2 Tu	2 Th	2 Su	2 Tu
3 Th	3 Su	3 We 36	3 Fr Day of German unity	3 Mo	3 We 49
4 Fr	4 Mo	4 Th	4 Sa	4 Tu	4 Th
5 Sa	5 Tu	5 Fr	5 Su	5 We 45	5 Fr
6 Su	6 We 32	6 Sa	6 Mo	6 Th	6 Sa
7 Mo	7 Th	7 Su	7 Tu	7 Fr	7 Su
8 Tu	8 Fr	8 Mo	8 We 41	8 Sa	8 Mo
9 We 28	9 Sa	9 Tu	9 Th	9 Su	9 Tu
10 Th	10 Su	10 We 37	10 Fr	10 Mo	10 We 50
11 Fr	11 Mo	11 Th	11 Sa	11 Tu	11 Th
12 Sa	12 Tu	12 Fr	12 Su	12 We 46	12 Fr
13 Su	13 We 33	13 Sa	13 Mo	13 Th	13 Sa
14 Mo	14 Th	14 Su	14 Tu	14 Fr	14 Su
15 Tu	15 Fr	15 Mo	15 We 42	15 Sa	15 Mo
16 We 29	16 Sa	16 Tu	16 Th	16 Su	16 Tu
17 Th	17 Su	17 We 38	17 Fr	17 Mo	17 We 51
18 Fr	18 Mo	18 Th	18 Sa	18 Tu	18 Th
19 Sa	19 Tu	19 Fr	19 Su	19 We 47	19 Fr
20 Su	20 We 34	20 Sa	20 Mo	20 Th	20 Sa
21 Mo	21 Th	21 Su	21 Tu	21 Fr	21 Su
22 Tu	22 Fr	22 Mo	22 We 43	22 Sa	22 Mo
23 We 30	23 Sa	23 Tu	23 Th	23 Su	23 Tu
24 Th	24 Su	24 We 39	24 Fr	24 Mo	24 We Christmas 52
25 Fr	25 Mo	25 Th	25 Sa	25 Tu	25 Th Christmas
26 Sa	26 Tu	26 Fr	26 Su	26 We 48	26 Fr Christmas
27 Su	27 We 35	27 Sa	27 Mo	27 Th	27 Sa
28 Mo	28 Th	28 Su	28 Tu	28 Fr	28 Su
29 Tu	29 Fr	29 Mo	29 We 44	29 Sa	29 Mo
30 We 31	30 Sa	30 Tu	30 Th	30 Su	30 Tu
31 Th	31 Su		31 Fr		31 We New Year Eve

Messetermine
IFA
IAA
eltefa

29.08.-03.09.2003, Berlin
11.09.-21.09.2003, Frankfurt
17.09.-19.09.2003, Stuttgart

elektrotechnik
MEDICA

08.10.-10.10.2003, Dortmund
19.11.-22.11. 2003, Düsseldorf

